



MODULAR WIRING ACCESSORIES



MODULES FAMILY

TYPE 45 SERIES USB CHARGER MODULES

TYPE 45 SERIES USB CHARGER MODULES

02-09



TYPE 45 SERIES POWER MODULES

10-21



TYPE 45 SERIES DATA AND MULTIMEDIA MODULES

22-30



CONTENTS

*Product images are for illustrative purposes only and may differ from the actual product.

TYPE 45 SERIES USB CHARGER MODULES

Single Port Type A 5W



LV-FBS-USB

Colors:	White, Black	USB output voltage:	DC 5.0V
Material:	PC	USB output current:	1A
Dimension:	22.5x45mm	Output voltage tolerance:	±5%
DC output power:	5W MAX	No-load power consumption:	0.2W MAX
Input voltage:	100~240V/AC 50~60HZ	Efficiency:	≥78%
Connection mode:	Screw terminals	Available surface finish:	Matte <input type="checkbox"/> Glossy <input checked="" type="checkbox"/>

Working temperature and humidity:

Environmental requirements: -10°C~+40°C 20%~90%RH

Storage temperature and humidity: -20°C~+85°C 10%~95%RH

Features

- Colors Available: White and Black (Can be supplied in any RAL color to meet your requirements. Subject to MOQ)
- Single Port USB charger Type A 1A version.
- With smart chip that enables accurate device recognition for fast & effective charging.
- Approval: REACH, RoHS.

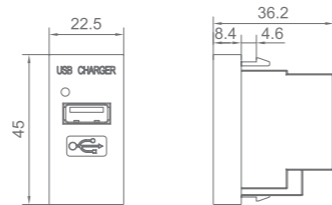

LV-FBS-USBD: Dual Port Type A+A 10.5W (total)



LV-FBS-USBD

Colors:	White, Black	USB output voltage:	DC 5.0V
Material:	PC	USB output current:	2.1A
Dimension:	22.5x45mm	Output voltage tolerance:	±5%
DC output power:	10.5W for total	No-load power consumption:	0.20W MAX
Input voltage:	100~240V/AC 50~60HZ	Efficiency:	≥78%
Connection mode:	Screw terminals	Available surface finish:	Matte <input type="checkbox"/> Glossy <input checked="" type="checkbox"/>

Working temperature and humidity:

Environmental requirements: -10°C~+40°C 20%~90%RH

Storage temperature and humidity: -20°C~+85°C 10%~95%RH

Features

- Colors Available: White and Black (Can be supplied in any RAL color to meet your requirements. Subject to MOQ)
- Dual Port USB charger Type A+A 2.1A version.
- With smart chip that enables accurate device recognition for fast & effective charging.

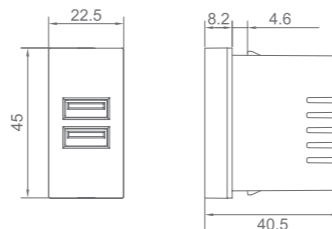

LV-FBS-USBC: Dual Port Type A+C 10.5W (total)



LV-FBS-USBC

Colors:	White, Black	USB output voltage:	DC 5.0V
Material:	PC	USB output current:	2.1A
Dimension:	22.5x45mm	Output voltage tolerance:	±5%
DC output power:	10.5W for total	No-load power consumption:	0.2W MAX
Input voltage:	100~240V/AC 50~60HZ	Efficiency:	≥78%
Connection mode:	Screw terminals	Available surface finish:	Matte <input type="checkbox"/> Glossy <input checked="" type="checkbox"/>

Working temperature and humidity:

Environmental requirements: -10°C~+40°C 20%~90%RH

Storage temperature and humidity: -20°C~+85°C 10%~95%RH

Features

- Colors Available: White and Black (Can be supplied in any RAL color to meet your requirements. Subject to MOQ)
- Dual Port USB charger Type A+C 2.1A version.
- With smart chip that enables accurate device recognition for fast & effective charging.

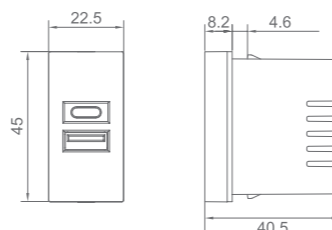

Features

- Colors Available: White and Black (Can be supplied in any RAL color to meet your requirements. Subject to MOQ)
- Dual Port USB charger Type A+A 2.1A version.
- With smart chip that enables accurate device recognition for fast & effective charging.
- Approval: REACH, RoHS.

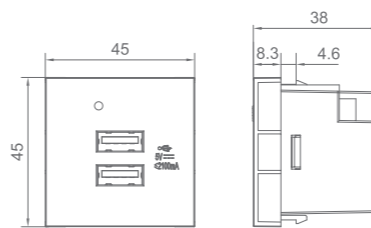

Features

- Colors Available: White and Black (Can be supplied in any RAL color to meet your requirements. Subject to MOQ)
- Dual Port USB charger Type A+A 4.2A version.
- With smart chip that enables accurate device recognition for fast & effective charging.
- Approval: CB, CE, REACH, RoHS.

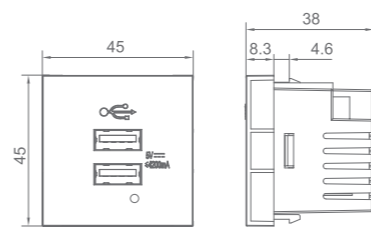

Features

- Colors Available: White and Black (Can be supplied in any RAL color to meet your requirements. Subject to MOQ)
- Dual Port USB charger Type A+C 2.1A version.
- With smart chip that enables accurate device recognition for fast & effective charging.

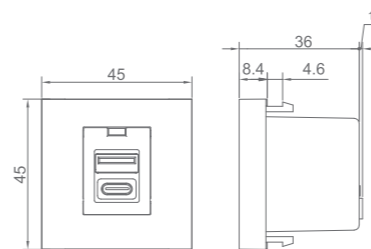

TYPE 45 SERIES USB CHARGER MODULES

LV-FBS-USBDs (2.1A): Dual Port Type A+A 10.5W (total)



LV-FBS-USBDs

Colors:	White, Black	USB output voltage:	DC 5.0V
Material:	PC	USB output current:	2.1A
Dimension:	45x45mm	Output voltage tolerance:	±5%
DC output power:	10.5W for total	No-load power consumption:	0.2W MAX
Input voltage:	100~240V/AC 50~60HZ	Efficiency:	≥78%
Connection mode:	Screw terminals	Available surface finish:	Matte <input checked="" type="checkbox"/> Glossy <input checked="" type="checkbox"/>

Working temperature and humidity:

Environmental requirements: -10°C~+40°C 20%~90%RH

Storage temperature and humidity: -20°C~+85°C 10%~95%RH

LV-FBS-USBDs (4.2A): Dual Port Type A+A 21W (total)



LV-FBS-USBDs

Colors:	White, Black	USB output voltage:	DC 5.0V
Material:	PC	USB output current:	4.2A
Dimension:	45x45mm	Output voltage tolerance:	±5%
DC output power:	10.5W for single, 21.0W for total	No-load power consumption:	0.10W MAX
Input voltage:	100~240V/AC 50~60HZ	Efficiency:	≥83%
Connection mode:	Screw terminals	Available surface finish:	Matte <input checked="" type="checkbox"/> Glossy <input checked="" type="checkbox"/>

Working temperature and humidity:

Environmental requirements: -10°C~+40°C 20%~90%RH

Storage temperature and humidity: -20°C~+85°C 10%~95%RH

LV-FBS-USBCs: Dual Port Type A+C 10.5W (total)



LV-FBS-USBCs

Colors:	White, Black	USB output voltage:	DC 5.0V
Material:	PC	USB output current:	2.1A
Dimension:	45x45mm	Output voltage tolerance:	±5%
DC output power:	10.5W for total	No-load power consumption:	0.2W MAX
Input voltage:	100~240V/AC 50~60HZ	Efficiency:	≥78%
Connection mode:	Screw terminals	Available surface finish:	Matte <input type="checkbox"/> Glossy <input checked="" type="checkbox"/>

Working temperature and humidity:

Environmental requirements: -10°C~+40°C 20%~90%RH

Storage temperature and humidity: -20°C~+85°C 10%~95%RH

TYPE 45 SERIES USB CHARGER MODULES

LV-FBS-USBs: Single Port Type A 10.5W



LV-FBS-USBs

Colors:	White, Black	USB output voltage:	DC 5.0V
Material:	PC	USB output current:	2.1A
Dimension:	45x45mm	Output voltage tolerance:	±5%
DC output power:	10.5W MAX	No-load power consumption:	0.2W MAX
Input voltage:	100~240V/AC 50~60HZ	Efficiency:	≥78%
Connection mode:	Screw terminals	Available surface finish:	Matte <input type="checkbox"/> Glossy <input checked="" type="checkbox"/>

Working temperature and humidity:

Environmental requirements: -10°C~+40°C 20%~90%RH

Storage temperature and humidity: -20°C~+85°C 10%~95%RH

LV-FBS-USBCs: Dual Port Type A+C 21W (total)

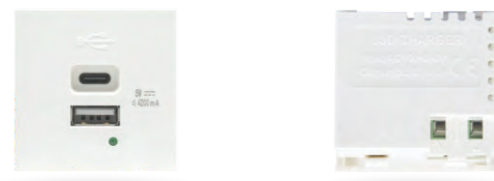

LV-FBS-USBCs (4.2A)

Colors:	White, Black	USB output voltage:	DC 5.0V
Material:	PC	USB output current:	4.2A
Dimension:	45x45mm	Output voltage tolerance:	±5%
DC output power:	10.5W for single, 21.0W for total	No-load power consumption:	0.10W MAX
Input voltage:	100~240V/AC 50~60HZ	Efficiency:	≥83%
Connection mode:	Screw terminals	Available surface finish:	Matte <input checked="" type="checkbox"/> Glossy <input checked="" type="checkbox"/>

Working temperature and humidity:

Environmental requirements: -10°C~+40°C 20%~90%RH

Storage temperature and humidity: -20°C~+85°C 10%~95%RH

LV-FBS-CDs: Dual Port Type C+C 10.5W (total)



LV-FBS-CDs

Colors:	White, Black	USB output voltage:	DC 5.0V
Material:	PC	USB output current:	2.1A
Dimension:	45x45mm	Output voltage tolerance:	±5%
DC output power:	10.5W MAX	No-load power consumption:	0.2W MAX
Input voltage:	100~240V/AC 50~60HZ	Efficiency:	≥78%
Connection mode:	Screw terminals	Available surface finish:	Matte <input type="checkbox"/> Glossy <input checked="" type="checkbox"/>

Working temperature and humidity:

Environmental requirements: -10°C~+40°C 20%~90%RH

Storage temperature and humidity: -20°C~+85°C 10%~95%RH

Features

- Colors Available: White and Black (Can be supplied in any RAL color to meet your requirements. Subject to MOQ)
- Single Port USB charger Type A 2.1A version.
- With smart chip that enables accurate device recognition for fast & effective charging.
- Approval: REACH, RoHS.

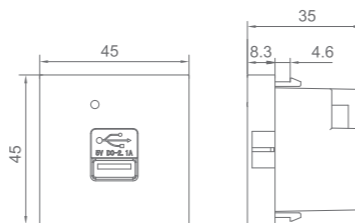

Features

- Colors Available: White and Black (Can be supplied in any RAL color to meet your requirements. Subject to MOQ)
- Dual Port USB charger Type A+C 4.2A version.
- With smart chip that enables accurate device recognition for fast & effective charging.
- Approval: CB, CE, REACH, RoHS.

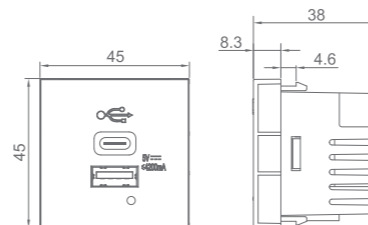

Features

- Colors Available: White and Black (Can be supplied in any RAL color to meet your requirements. Subject to MOQ)
- Dual Port USB charger Type C+C 2.1A version.
- With smart chip that enables accurate device recognition for fast & effective charging.
- Approval: REACH, RoHS.

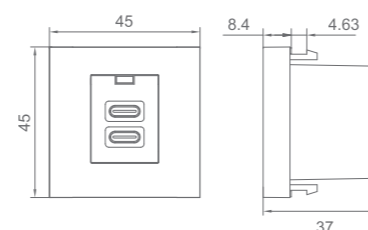

Features

- Colors Available: White and Black (Can be supplied in any RAL color to meet your requirements. Subject to MOQ)
- Dual Port USB charger Type A+A 2.1A version.
- With smart chip that enables accurate device recognition for fast & effective charging.

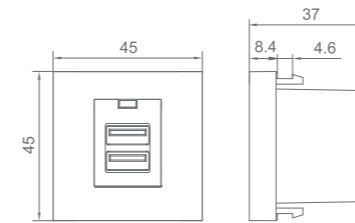

Features

- Colors Available: White and Black (Can be supplied in any RAL color to meet your requirements. Subject to MOQ)
- Dual Port USB charger Type C+C 4.2A version.
- With smart chip that enables accurate device recognition for fast & effective charging.

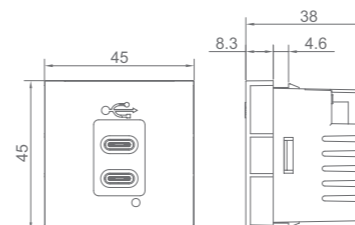

Features

- Colors Available: White and Black (Can be supplied in any RAL color to meet your requirements. Subject to MOQ)
- Single Type A USB Quick Charger.
- Supports USB QC3.0 protocol.
- With smart chip that enables accurate device recognition for fast & effective charging.
- Approval: REACH, RoHS.

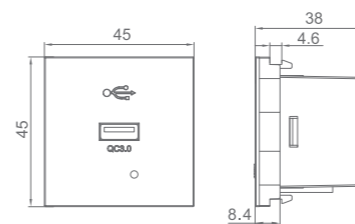

TYPE 45 SERIES USB CHARGER MODULES

LV-FBS-USBDs-2: Dual Port Type A+A 10.5W (total)



LV-FBS-USBDs-2

Colors:	White, Black	USB output voltage:	DC 5.0V
Material:	PC	USB output current:	2.1A
Dimension:	45x45mm	Output voltage tolerance:	±5%
DC output power:	10.5W MAX	No-load power consumption:	0.2W MAX
Input voltage:	100~240V/AC 50~60HZ	Efficiency:	≥78%
Connection mode:	Screw terminals	Available surface finish:	Matte <input type="checkbox"/> Glossy <input checked="" type="checkbox"/>

Working temperature and humidity:

Environmental requirements: -10°C~+40°C 20%~90%RH

Storage temperature and humidity: -20°C~+85°C 10%~95%RH

LV-FBS-CDs-2: Dual Port Type C+C 21W (total)

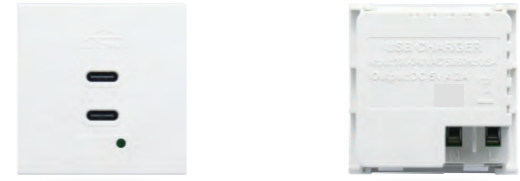

LV-FBS-CDs-2

Colors:	White, Black	USB output voltage:	DC 5.0V
Material:	PC	USB output current:	3A single
Dimension:	45x45mm	Output voltage tolerance:	±5%
DC output power:	21W MAX	No-load power consumption:	0.2W MAX
Input voltage:	100~240V/AC 50~60HZ	Efficiency:	≥78%
Connection mode:	Screw terminals	Available surface finish:	Matte <input checked="" type="checkbox"/> Glossy <input checked="" type="checkbox"/>

Working temperature and humidity:

Environmental requirements: -10°C~+40°C 20%~90%RH

Storage temperature and humidity: -20°C~+85°C 10%~95%RH

LV-FBS-USBDs-2: Single Port Type A 18W with QC3.0



LV-FBS-USBDs-2

Colors:	White, Black	Output current voltage:	5V=3A, 9V=2A, 12V=1.5A
Material:	PC	Dimension:	45x45mm
DC output power:	18W MAX	No-load power consumption:	0.2W MAX
Input voltage:	100~240V/AC 50~60HZ	Efficiency:	≥78%
Connection mode:	Screw terminals	Available surface finish:	Matte <input type="checkbox"/> Glossy <input checked="" type="checkbox"/>

Working temperature and humidity:

Environmental requirements: -10°C~+40°C 20%~90%RH

Storage temperature and humidity: -20°C~+85°C 10%~95%RH

TYPE 45 SERIES USB CHARGER MODULES

LV-FBS-Cs: Single Port Type C 20W with PD

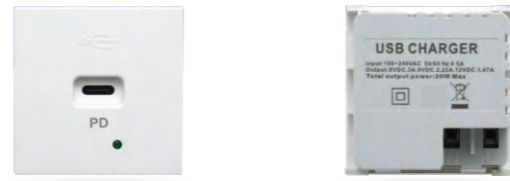

LV-FBS-Cs

Colors:	White, Black	Output current voltage:	5V=3A, 9V=2A, 12V=1.67A
Material:	PC	Dimension:	45x45mm
DC output power:	20W MAX	No-load power consumption:	0.2W MAX
Input voltage:	100~240V/AC 50~60HZ	Efficiency:	≥78%
Connection mode:	Screw terminals	Available surface finish:	Matte <input checked="" type="checkbox"/> Glossy <input checked="" type="checkbox"/>

Working temperature and humidity:

Environmental requirements: -10°C~+40°C 20%~90%RH

Storage temperature and humidity: -20°C~+85°C 10%~95%RH

LV-FBS-USBCs-PD: Dual Port Type A+C 20W with PD, QC3.0

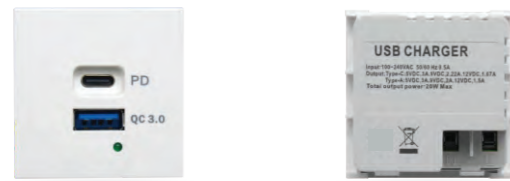

LV-FBS-USBCs-PD

Colors:	White, Black	Output current voltage:	Type-A+Type-C: 5V=3A total
Material:	PC	Dimension:	Type-A: 5V=3A, 9V=2A, 12V=1.5A Type-C: 5V=3A, 9V=2A, 12V=1.67A
DC output power:	20W MAX	No-load power consumption:	0.2W MAX
Input voltage:	100~240V/AC 50~60HZ	Efficiency:	≥78%
Connection mode:	Screw terminals	Available surface finish:	Matte <input checked="" type="checkbox"/> Glossy <input checked="" type="checkbox"/>

Working temperature and humidity:

Environmental requirements: -10°C~+40°C 20%~90%RH

Storage temperature and humidity: -20°C~+85°C 10%~95%RH

LV-FBS-USBCs-PD30: Dual Port Type A+C 30W with PD, QC3.0

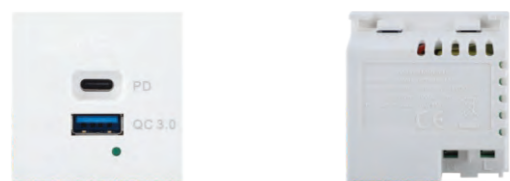

LV-FBS-USBCs-PD30

Colors:	White, Black	Output current voltage:	Type-A+Type-C: 5V=2.4A total
Material:	PC	Dimension:	Type-A: 5V=3A, 9V=3A, 12V=2.5A, 20V=1.5A Type-C: 5V=3A, 9V=3A, 12V=2.5A, 15V=2A, 20V=1.5A
DC output power:	30W MAX	No-load power consumption:	0.06W MAX
Input voltage:	100~240V/AC 50~60HZ	Efficiency:	≥85.6%
Connection mode:	Screw terminals	Available surface finish:	Matte <input checked="" type="checkbox"/> Glossy <input checked="" type="checkbox"/>

Working temperature and humidity:

Environmental requirements: -10°C~+40°C 20%~90%RH

Storage temperature and humidity: -20°C~+85°C 10%~95%RH

Features

- Colors Available: White and Black (Can be supplied in any RAL color to meet your requirements. Subject to MOQ)
- Single Type C USB Quick Charger.
- Supports USB PD and QC3.0 protocol.
- With smart chip that enables accurate device recognition for fast & effective charging.
- Approval: REACH, RoHS.

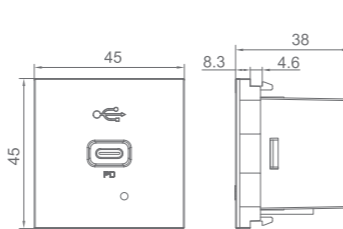

Features

- Colors Available: White and Black (Can be supplied in any RAL color to meet your requirements. Subject to MOQ)
- Dual Port USB Quick charger Type A+C.
- Supports USB PD and QC3.0 protocol.
- With smart chip that enables accurate device recognition for optimized & effective charging.

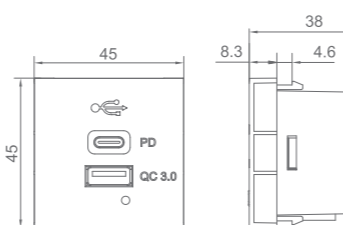

Features

- Colors Available: White and Black (Can be supplied in any RAL color to meet your requirements. Subject to MOQ)
- Dual Port USB Quick charger Type A+C.
- Supports USB PD and QC3.0 protocol.
- With smart chip that enables accurate device recognition for optimized & effective charging.
- Approval: CB, CE, RoHS, REACH

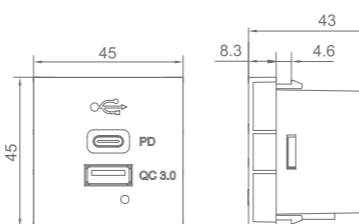

Features

- Colors Available: White and Black (Can be supplied in any RAL color to meet your requirements. Subject to MOQ)
- Dual Port USB Quick charger Type A+C.
- Supports USB PD and QC3.0 protocol.
- With smart chip that enables accurate device recognition for optimized & effective charging.

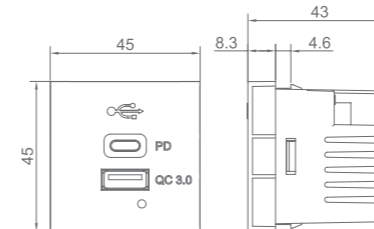

Features

- Colors Available: White and Black (Can be supplied in any RAL color to meet your requirements. Subject to MOQ)
- Dual Port USB Quick charger Type A+C.
- Supports USB PD and QC3.0 protocol.
- With smart chip that enables accurate device recognition for optimized & effective charging.

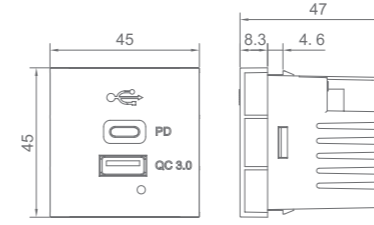

Features

- Colors Available: White and Black (Can be supplied in any RAL color to meet your requirements. Subject to MOQ)
- Dual Port USB Quick charger Type C+C.
- Supports USB PD protocol.
- With smart chip that enables accurate device recognition for optimized & effective charging.

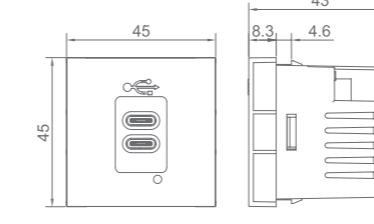

TYPE 45 SERIES USB CHARGER MODULES

LV-FBS-USBCs-PD40: Dual Port Type A+C 45W with PD, QC3.0

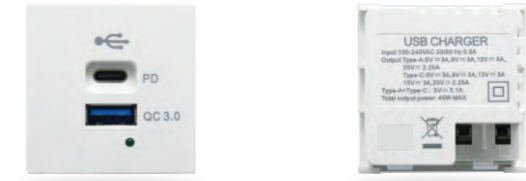

LV-FBS-USBCs-PD40

Colors:	White, Black	Output current voltage:	Type-A+Type-C: 5V=3.1A total
Material:	PC	Dimension:	Type-A: 5V=3A, 9V=3A, 12V=3A, 20V=2.25A Type-C: 5V=3A, 9V=3A, 12V=3A, 15V=3A, 20V=2.25A
DC output power:	45W MAX	No-load power consumption:	0.1W MAX
Input voltage:	100~240V/AC 50~60HZ	Available surface finish:	Matte <input checked="" type="checkbox"/> Glossy <input checked="" type="checkbox"/>
Connection mode:	Screw terminals		

Working temperature and humidity:

Environmental requirements: -10°C~+40°C 20%~90%RH

Storage temperature and humidity: -20°C~+85°C 10%~95%RH

LV-FBS-USBCs-PD65: Dual Port Type A+C 65W with PD, QC3.0

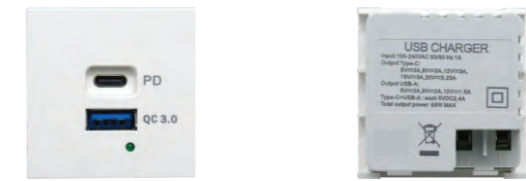

LV-FBS-USBCs-PD65

Colors:	White, Black	Output current voltage:	Type-A+Type-C: 5V=2.4A total
Material:	PC	Dimension:	Type-A: 5V=3A, 9V=2A, 12V=1.5A Type-C: 5V=3A, 9V=3A, 12V=3A, 15V=3A, 20V=3.25A
DC output power:	65W MAX	No-load power consumption:	0.21W MAX
Input voltage:	100~240V/AC 50~60HZ	Available surface finish:	Matte <input checked="" type="checkbox"/> Glossy <input checked="" type="checkbox"/>
Connection mode:	Screw terminals		

Working temperature and humidity:

Environmental requirements: -10°C~+40°C 20%~90%RH

Storage temperature and humidity: -20°C~+85°C 10%~95%RH

LV-FBS-CDs-PD30: Dual Port Type C+C 30W with PD

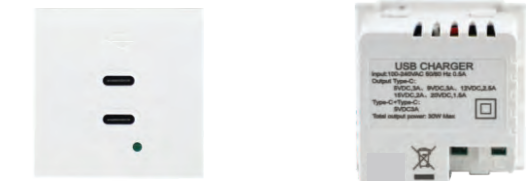

LV-FBS-CDs-PD30

Colors:	White, Black	Output current voltage:	Type-C+Type-C: 5V=3A total
Material:	PC	Dimension:	Type-C: 5V=3A, 9V=3A, 12V=2.5A 15V=2A, 20V=1.5A
DC output power:	30W MAX	No-load power consumption:	0.1W MAX
Input voltage:	100~240V/AC 50~60HZ	Available surface finish:	Matte <input checked="" type="checkbox"/> Glossy <input checked="" type="checkbox"/>
Connection mode:	Screw terminals		

Working temperature and humidity:

Environmental requirements: -10°C~+40°C 20%~90%RH

Storage temperature and humidity: -20°C~+85°C 10%~95%RH

TYPE 45 SERIES USB CHARGER MODULES

LV-FBS-KS-USB: Keystone Type A 5W



LV-FBS-KS-USB

Colors:	White, Black	USB output voltage:	DC 5.0V
Material:	PC	USB output current:	1A
Dimension:	16.1x14.5mm	Output voltage tolerance:	±5%
DC output power:	5W MAX	No-load power consumption:	0.2W MAX
Input voltage:	100~240V/AC 50~60HZ	Efficiency:	≥78%
Connection mode:	Screw terminals		

Working temperature and humidity:

Environmental requirements: -10°C~+40°C 20%~90%RH

Storage temperature and humidity: -20°C~+85°C 10%~95%RH

LV-FBS-KS-USB (10.5W): Keystone Type A 10.5W



LV-FBS-KS-USB

Colors:	White, Black	USB output voltage:	DC 5.0V
Material:	PC	USB output current:	2.1A
Dimension:	16.1x14.5mm	Output voltage tolerance:	±5%
DC output power:	10.5W MAX	No-load power consumption:	0.2W MAX
Input voltage:	100~240V/AC 50~60HZ	Efficiency:	≥78%
Connection mode:	Screw terminals		

Working temperature and humidity:

Environmental requirements: -10°C~+40°C 20%~90%RH

Storage temperature and humidity: -20°C~+85°C 10%~95%RH

LV-FBS-KS-C: Keystone Type C 10.5W



LV-FBS-KS-C

Colors:	White, Black	USB output voltage:	DC 5.0V
Material:	PC	USB output current:	2.1A
Dimension:	16.1x14.5mm	Output voltage tolerance:	±5%
DC output power:	10.5W MAX	No-load power consumption:	0.2W MAX
Input voltage:	100~240V/AC 50~60HZ	Efficiency:	≥78%
Connection mode:	Screw terminals		

Working temperature and humidity:

Environmental requirements: -10°C~+40°C 20%~90%RH

Storage temperature and humidity: -20°C~+85°C 10%~95%RH

Features

- Colors Available: White and Black (Can be supplied in any RAL color to meet your requirements. Subject to MOQ)
- Single Port USB charger Type A 1A version.
- Easily snaps into all keystone wall plates, patch panels or surface-mount box.
- With smart chip that enables accurate device recognition for optimized & effective charging.
- Approval: CE-LVD, SAA.

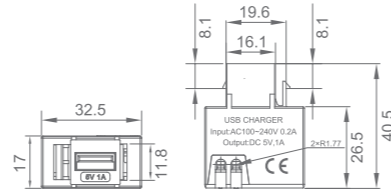

Features

- Colors Available: White and Black (Can be supplied in any RAL color to meet your requirements. Subject to MOQ)
- Single Port USB charger Type A 2.1A version.
- Easily snaps into all keystone wall plates, patch panels or surface-mount box.
- With smart chip that enables accurate device recognition for optimized & effective charging.
- Approval: CE-LVD, SAA.

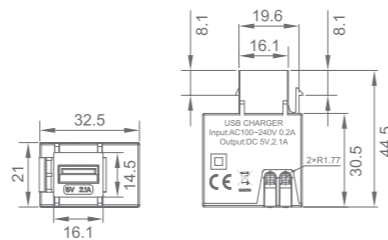

Features

- Colors Available: White and Black (Can be supplied in any RAL color to meet your requirements. Subject to MOQ)
- Single Port USB charger Type C 2.1A version.
- Easily snaps into all keystone wall plates, patch panels or surface-mount box.
- With smart chip that enables accurate device recognition for optimized & effective charging.
- Approval: CE-LVD, SAA.

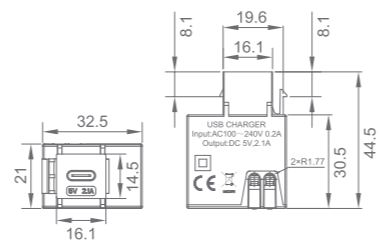

TYPE 45 SERIES POWER MODULES



TYPE 45 SERIES POWER MODULES

LV-FBS-switch1: Electrical switch 10A



LV-FBS-switch1-1G: One way electrical switch LV-FBS-switch1-2G: Two way electrical switch

Model	Material	Voltage	Current Capability	Dimension (mm)
switch1-1G	PC	250V	10A	22.5x45
switch1-2G	PC	250V	10A	22.5x45

Working Temperature and Humidity:

Environmental requirements: -10°C~+40°C 20%~90%RH
Storage temperature and humidity: -20°C~+85°C 10%~95%RH

LV-FBS-switch2: Electrical switch 16A



LV-FBS-switch2-1G: One way electrical switch LV-FBS-switch2-2G: Two way electrical switch

Model	Material	Voltage	Current Capability	Dimension (mm)
switch2-1G	PC	250V	16A	22.5x45
switch2-2G	PC	250V	16A	22.5x45

Working Temperature and Humidity:

Environmental requirements: -10°C~+40°C 20%~90%RH
Storage temperature and humidity: -20°C~+85°C 10%~95%RH

LV-FBS-switch: Arc-shaped electrical switch 10A



LV-FBS-switch1G: Arc-shaped One way electrical switch LV-FBS-switch2G: Arc-shaped Two way electrical switch

Model	Material	Voltage	Current Capability	Dimension (mm)
switch1G	PC	250V	10A	22.5x45
switch2G	PC	250V	10A	22.5x45

Working Temperature and Humidity:

Environmental requirements: -10°C~+40°C 20%~90%RH
Storage temperature and humidity: -20°C~+85°C 10%~95%RH

Features

- Colors Available: White and Black (Can be supplied in any RAL color to meet your requirements. Subject to MOQ)
- Available Surface Finish: Matte Glossy
- Screw terminals.

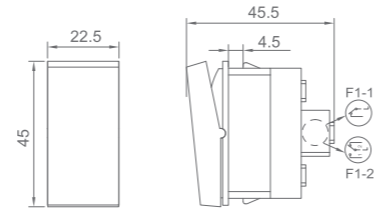

Features

- Colors Available: White and Black (Can be supplied in any RAL color to meet your requirements. Subject to MOQ)
- Available Surface Finish: Matte Glossy
- Screw terminals.

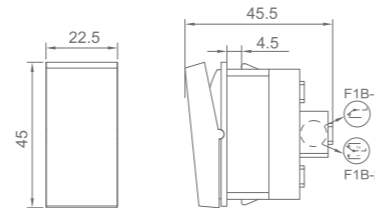

Features

- Colors Available: White and Black (Can be supplied in any RAL color to meet your requirements. Subject to MOQ)
- Available Surface Finish: Matte Glossy
- Screw terminals.

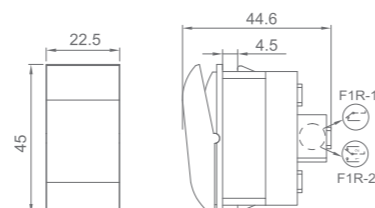

Features

- Colors Available: White and Black (Can be supplied in any RAL color to meet your requirements. Subject to MOQ)
- Available Surface Finish: Matte Glossy
- Screw terminals.

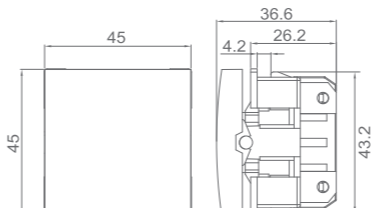

Features

- Colors Available: White and Black (Can be supplied in any RAL color to meet your requirements. Subject to MOQ)
- Available Surface Finish: Matte Glossy
- 2 pin socket with safety shutter.
- Screw terminals.
- Approval: RoHS.

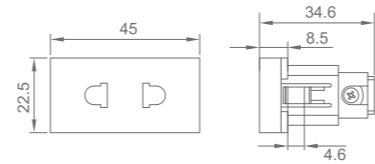

Features

- Colors Available: White and Black (Can be supplied in any RAL color to meet your requirements. Subject to MOQ)
- Available Surface Finish: Matte Glossy
- 2P+E socket with safety shutter.
- Screw terminals.
- Approval: SAA, RCM.

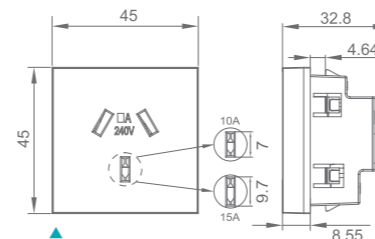

TYPE 45 SERIES POWER MODULES

LV-FBS-switch1s: Electrical switch 10A



LV-FBS-switch1s-1G: One way electrical switch LV-FBS-switch1s-2G: Two way electrical switch

Model	Material	Voltage	Current Capability	Dimension (mm)
switch1s-1G	PC	250V	10A	45x45
switch1s-2G	PC	250V	10A	45x45

Working Temperature and Humidity:

Environmental requirements: -10°C~+40°C 20%~90%RH
Storage temperature and humidity: -20°C~+85°C 10%~95%RH

LV-FBS-S1: Euro/US standard two-pin socket



Model	Material	Voltage	Current Capability	Dimension (mm)
S1	PC	250V	10A	22.5x45

Working Temperature and Humidity:

Environmental requirements: -10°C~+40°C 20%~90%RH
Storage temperature and humidity: -20°C~+85°C 10%~95%RH

LV-FBS-S2: Australian standard three-pin socket



Model	Material	Voltage	Current Capability	Dimension (mm)
S2-10A	PC	240V	10A	45x45
S2-15A	PC	240V	15A	45x45

Working Temperature and Humidity:

Environmental requirements: -10°C~+40°C 20%~90%RH
Storage temperature and humidity: -20°C~+85°C 10%~95%RH

TYPE 45 SERIES POWER MODULES

LV-FBS-5: Multi-standard socket



FBS-5-10A

FBS-5-13A

Model	Material	Voltage	Current Capability	Dimension (mm)
FBS-5-10A	PC	250V	10A	45x45
FBS-5-13A	PC	250V	13A	45x45

Working Temperature and Humidity:

Environmental requirements: -10°C~+40°C 20%~90%RH
Storage temperature and humidity: -20°C~+85°C 10%~95%RH

Features

- Colors Available: White and Black (Can be supplied in any RAL color to meet your requirements. Subject to MOQ)
- Available Surface Finish: Matte Glossy
- 2P+E socket with safety shutter.
- Screw terminals.

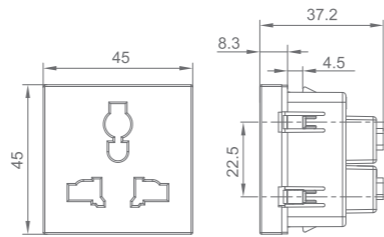

Features

- Colors Available: White and Black (Can be supplied in any RAL color to meet your requirements. Subject to MOQ)
- Available Surface Finish: Matte Glossy
- 2P+E socket with safety shutter.
- Screw terminals.

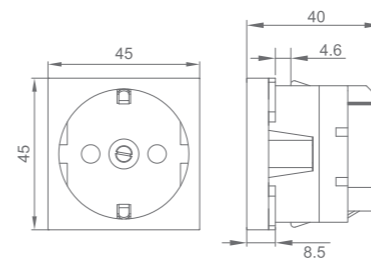

TYPE 45 SERIES POWER MODULES

LV-FBS-6T: Schuko socket with screw-on mounting plate



FBS-6T

Model	Material	Voltage	Current Capability	Dimension (mm)
FBS-6T	PC	250V	16A	45x45

Working Temperature and Humidity:

Environmental requirements: -10°C~+40°C 20%~90%RH
Storage temperature and humidity: -20°C~+85°C 10%~95%RH

Features

- Colors Available: White and Black (Can be supplied in any RAL color to meet your requirements. Subject to MOQ)
- Available Surface Finish: Matte Glossy
- 2P+E socket with safety shutter.
- Quick connect terminal(Solid wire).

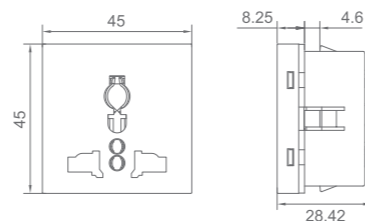

Features

- Colors Available: White and Black (Can be supplied in any RAL color to meet your requirements. Subject to MOQ)
- Available Surface Finish: Matte Glossy
- 45° orientation.
- 2P+E socket with safety shutter.
- Screw terminals.
- With metal clip accessories, you can fix multiples sockets in parallel orientation.
- Approval: RoHS.

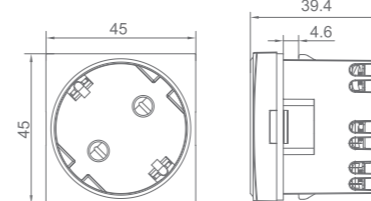

LV-FBS-6DC: Schuko socket 45°, gangable



FBS-6DC

Supplied separately

Model	Material	Voltage	Current Capability	Dimension (mm)
FBS-6DC	PC	250V	16A	45x45

Working Temperature and Humidity:

Environmental requirements: -10°C~+40°C 20%~90%RH
Storage temperature and humidity: -20°C~+85°C 10%~95%RH

LV-FBS-5FC: Universal socket

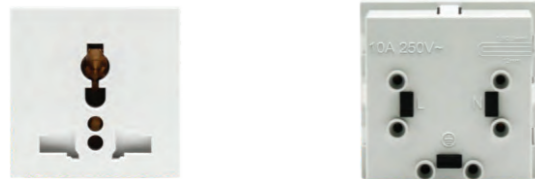

FBS-5FC

Model	Material	Voltage	Current Capability	Dimension (mm)
FBS-5FC	PC	250V	10A	45x45

Working Temperature and Humidity:

Environmental requirements: -10°C~+40°C 20%~90%RH
Storage temperature and humidity: -20°C~+85°C 10%~95%RH

Features

- Colors Available: White / Black and Red (Can be supplied in any RAL color to meet your requirements. Subject to MOQ)
- Available Surface Finish: Matte Glossy
- 2P+E socket with safety shutter.
- Screw terminals.
- Approval: RoHS.

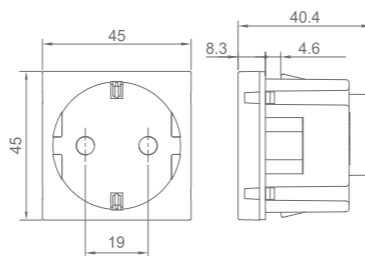

Features

- Colors Available: White and Black (Can be supplied in any RAL color to meet your requirements. Subject to MOQ)
- Available Surface Finish: Matte Glossy
- 45° orientation.
- 2P+E socket with safety shutter.
- Quick connect terminal(Solid wire).
- Approval: TUV mark, RoHS.

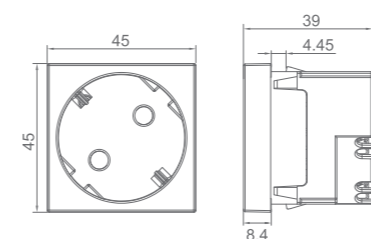

LV-FBS-6D: Schuko socket 45°



FBS-6D

FBS-6DB

Model	Material	Voltage	Current Capability	Dimension (mm)
FBS-6D	PC	250V	16A	45x45

Working Temperature and Humidity:

Environmental requirements: -10°C~+40°C 20%~90%RH
Storage temperature and humidity: -20°C~+85°C 10%~95%RH

LV-FBS-6: Schuko socket



FBS-6

FBS-6R

Model	Material	Voltage	Current Capability	Dimension (mm)
FBS-6	PC	250V	16A	45x45

Working Temperature and Humidity:

Environmental requirements: -10°C~+40°C 20%~90%RH
Storage temperature and humidity: -20°C~+85°C 10%~95%RH

TYPE 45 SERIES POWER MODULES

LV-FBS-6D2: Schuko socket 45°, Two gang



FBS-6D2

Model	Material	Voltage	Current Capability	Dimension (mm)
FBS-6D2	PC	250V	16A	90x45

Working Temperature and Humidity:

Environmental requirements: -10°C~+40°C 20%~90%RH
Storage temperature and humidity: -20°C~+85°C 10%~95%RH

LV-FBS-6D3: Schuko socket 45°, Three gang



FBS-6D3

Model	Material	Voltage	Current Capability	Dimension (mm)
FBS-6D3	PC	250V	16A	135x45

Working Temperature and Humidity:

Environmental requirements: -10°C~+40°C 20%~90%RH
Storage temperature and humidity: -20°C~+85°C 10%~95%RH

Features

- Colors Available: White and Black (Can be supplied in any RAL color to meet your requirements. Subject to MOQ)
- Available Surface Finish: Matte Glossy
- 45° orientation.
- 2P+E socket with safety shutter.
- Quick connect terminal(Solid wire).
- Approval: TUV mark, RoHS.

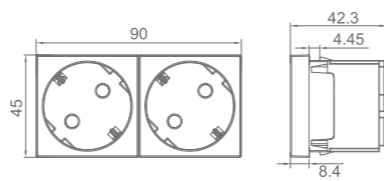

Features

- Colors Available: White and Black (Can be supplied in any RAL color to meet your requirements. Subject to MOQ)
- Available Surface Finish: Matte Glossy
- 45° orientation.
- 2P+E socket with safety shutter.
- Quick connect terminal(Solid wire).
- Approval: TUV mark, RoHS.

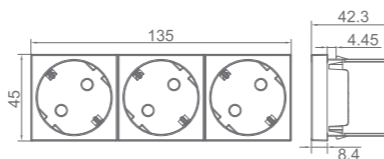

Features

- Colors Available: White and Black (Can be supplied in any RAL color to meet your requirements. Subject to MOQ)
- Available Surface Finish: Matte Glossy
- 2P+E socket with safety shutter.
- Screw terminals.

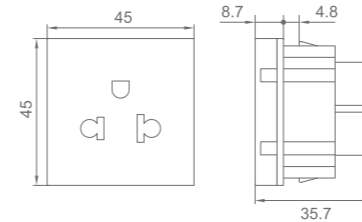

Features

- Colors Available: White and Black (Can be supplied in any RAL color to meet your requirements. Subject to MOQ)
- Available Surface Finish: Matte Glossy
- 2P+E socket with safety shutter.
- Screw terminals.
- Approval: TUV mark.

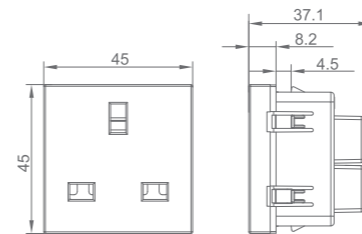

Features

- Colors Available: White and Black (Can be supplied in any RAL color to meet your requirements. Subject to MOQ)
- Available Surface Finish: Matte Glossy
- Double Pole Switch
- 2P+E socket with safety shutter.
- Screw terminals.
- Approval: GCC.

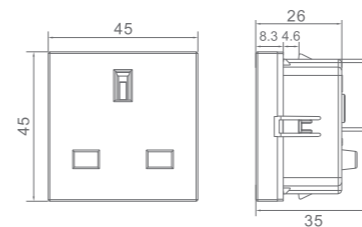

TYPE 45 SERIES POWER MODULES

LV-FBS-8: Euro/US standard socket



FBS-8

Model	Material	Voltage	Current Capability	Dimension (mm)
FBS-8	PC	250V	16A	45x45

Working Temperature and Humidity:

Environmental requirements: -10°C~+40°C 20%~90%RH
Storage temperature and humidity: -20°C~+85°C 10%~95%RH

LV-FBS-9: British standard socket

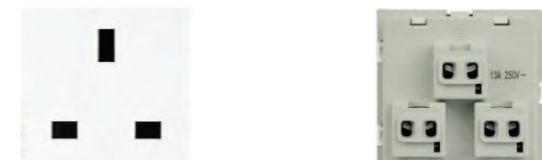

FBS-9

Model	Material	Voltage	Current Capability	Dimension (mm)
FBS-9	PC	250V	13A	45x45

Working Temperature and Humidity:

Environmental requirements: -10°C~+40°C 20%~90%RH
Storage temperature and humidity: -20°C~+85°C 10%~95%RH

LV-FBS-9G: British standard socket, Double pole



FBS-9G

Model	Material	Voltage	Current Capability	Dimension (mm)
FBS-9G	PC	250V	13A	45x45

Working Temperature and Humidity:

Environmental requirements: -10°C~+40°C 20%~90%RH
Storage temperature and humidity: -20°C~+85°C 10%~95%RH

TYPE 45 SERIES POWER MODULES

LV-FBS-9D: British standard socket 45°



FBS-9D

Model	Material	Voltage	Current Capability	Dimension (mm)
FBS-9D	PC	250V	13A	45x45

Working Temperature and Humidity:

Environmental requirements: -10°C~+40°C 20%~90%RH
Storage temperature and humidity: -20°C~+85°C 10%~95%RH

Features

- Colors Available: White and Black (Can be supplied in any RAL color to meet your requirements. Subject to MOQ)
- Available Surface Finish: Matte Glossy
- 45° orientation.
- 2P+E socket with safety shutter.
- Screw terminals.

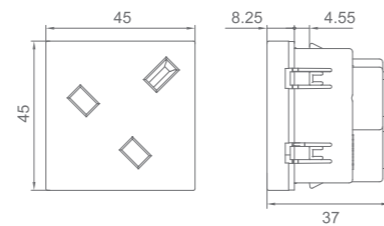

Features

- Colors Available: White and Black (Can be supplied in any RAL color to meet your requirements. Subject to MOQ)
- Available Surface Finish: Matte Glossy
- 2P+E socket with safety shutter.
- Screw terminals.

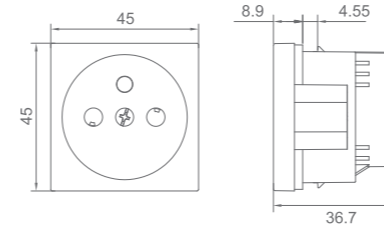

TYPE 45 SERIES POWER MODULES

LV-FBS-36: French socket with screw-on mounting plate



FBS-36

Model	Material	Voltage	Current Capability	Dimension (mm)
FBS-36	PC	250V	16A	45x45

Working Temperature and Humidity:

Environmental requirements: -10°C~+40°C 20%~90%RH
Storage temperature and humidity: -20°C~+85°C 10%~95%RH

Features

- Colors Available: White and Black (Can be supplied in any RAL color to meet your requirements. Subject to MOQ)
- Available Surface Finish: Matte Glossy
- 2P+E socket with safety shutter.
- Screw terminals.

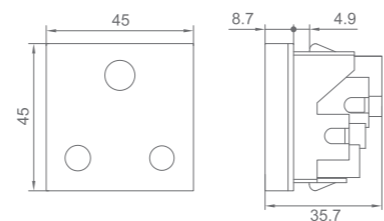

Features

- Colors Available: White and Black (Can be supplied in any RAL color to meet your requirements. Subject to MOQ)
- Available Surface Finish: Matte Glossy
- 2P+E socket with safety shutter.
- Supplied with tamperproof insert which fits directly into the plug
- Quick connect terminal(Solid wire).

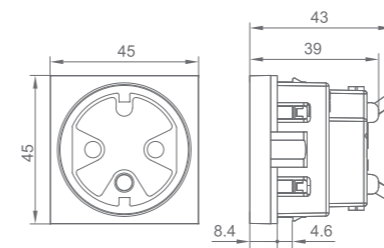

LV-FBS-36FC: French socket with tamperproof insert



FBS-36FC

Tamperproof insert

Model	Material	Voltage	Current Capability	Dimension (mm)
FBS-36FC	PC	250V	16A	45x45

Working Temperature and Humidity:

Environmental requirements: -10°C~+40°C 20%~90%RH
Storage temperature and humidity: -20°C~+85°C 10%~95%RH

LV-FBS-30: South African standard socket, SANS 164-1



FBS-30

Model	Material	Voltage	Current Capability	Dimension (mm)
FBS-30	PC	250V	16A	45x45

Working Temperature and Humidity:

Environmental requirements: -10°C~+40°C 20%~90%RH
Storage temperature and humidity: -20°C~+85°C 10%~95%RH

Features

- Colors Available: White and Black (Can be supplied in any RAL color to meet your requirements. Subject to MOQ)
- Available Surface Finish: Matte Glossy
- 2P+E socket with safety shutter.
- Screw terminals.
- Approval: RoHS.

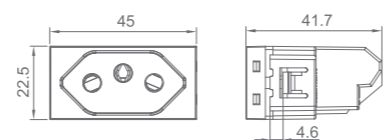

Features

- Colors Available: White and Black (Can be supplied in any RAL color to meet your requirements. Subject to MOQ)
- Available Surface Finish: Matte Glossy
- 45° orientation, screw terminals.
- 2P+E socket with safety shutter.
- Supplied with tamperproof insert which fits directly into the plug
- With metal clip accessories, you can fix multiples sockets in parallel orientation.

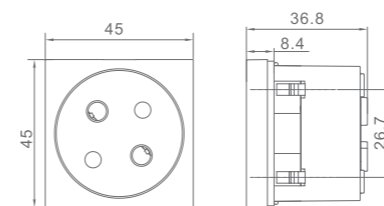

LV-FBS-36FS: French socket 45°, gangable with tamperproof insert



FBS-36FS

Accessories for Gangable fixing method

Supplied separately

Model	Material	Voltage	Current Capability	Dimension (mm)
FBS-36FS	PC	250V	16A	45x45

Working Temperature and Humidity:

Environmental requirements: -10°C~+40°C 20%~90%RH
Storage temperature and humidity: -20°C~+85°C 10%~95%RH

LV-FBS-30M: South African standard socket, SANS 164-2



FBS-30M

Model	Material	Voltage	Current Capability	Dimension (mm)
FBS-30M	PC	250V	16A	22.5x45

Working Temperature and Humidity:

Environmental requirements: -10°C~+40°C 20%~90%RH
Storage temperature and humidity: -20°C~+85°C 10%~95%RH

TYPE 45 SERIES POWER MODULES

LV-FBS-37: Italian standard socket, 16A



Model	Material	Voltage	Current Capability	Dimension (mm)
FBS-37	PC	250V	16A	22.5x45

Working Temperature and Humidity:

Environmental requirements: -10°C~+40°C 20%~90%RH
Storage temperature and humidity: -20°C~+85°C 10%~95%RH

LV-FBS-38: Italian standard socket, 10A



Model	Material	Voltage	Current Capability	Dimension (mm)
FBS-38	PC	250V	10A	22.5x45

Working Temperature and Humidity:

Environmental requirements: -10°C~+40°C 20%~90%RH
Storage temperature and humidity: -20°C~+85°C 10%~95%RH

LV-FBS-40: Brazilian standard socket



Model	Material	Voltage	Current Capability	Dimension (mm)
FBS-40/10W	PC	250V	10A	22.5x45
FBS-40/20W	PC	250V	20A	22.5x45

Working Temperature and Humidity:

Environmental requirements: -10°C~+40°C 20%~90%RH
Storage temperature and humidity: -20°C~+85°C 10%~95%RH

Features

- Colors Available: White and Black (Can be supplied in any RAL color to meet your requirements. Subject to MOQ)
- Available Surface Finish: Matte Glossy
- 2P+E socket with safety shutter.
- Screw terminals.

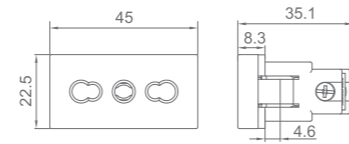

Features

- Colors Available: White and Black (Can be supplied in any RAL color to meet your requirements. Subject to MOQ)
- Available Surface Finish: Matte Glossy
- 2P+E socket with safety shutter.
- Screw terminals.

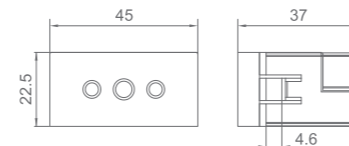

Features

- Colors Available: White and Black (Can be supplied in any RAL color to meet your requirements. Subject to MOQ)
- Available Surface Finish: Matte Glossy
- 2P+E socket with safety shutter.
- Screw terminals.

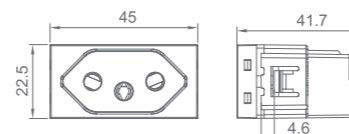

TYPE 45 SERIES POWER MODULES

LV-FBS-45: Swiss socket



Model	Material	Voltage	Current Capability	Dimension (mm)
FBS-45	PC	250V	10A	45x45

Working Temperature and Humidity:

Environmental requirements: -10°C~+40°C 20%~90%RH
Storage temperature and humidity: -20°C~+85°C 10%~95%RH

Features

- Colors Available: White and Black (Can be supplied in any RAL color to meet your requirements. Subject to MOQ)
- Available Surface Finish: Matte Glossy
- 2P+E socket with safety shutter.
- Screw terminals.

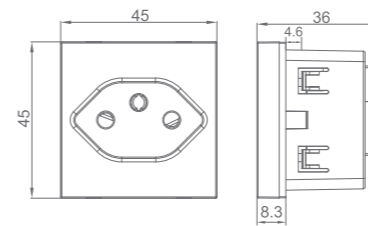

Features

- Colors Available: White and Black (Can be supplied in any RAL color to meet your requirements. Subject to MOQ)
- Available Surface Finish: Matte Glossy
- 2P+E socket with safety shutter.
- Screw terminals.

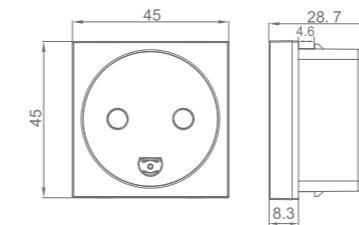

LV-FBS-46: Danish socket



Model	Material	Voltage	Current Capability	Dimension (mm)
FBS-46	PC	250V	13A	45x45

Working Temperature and Humidity:

Environmental requirements: -10°C~+40°C 20%~90%RH
Storage temperature and humidity: -20°C~+85°C 10%~95%RH

TYPE 45 SERIES POWER MODULES

LV-FBS-42: Smart switch, one module size



Model:	FBS-42	Color:	White
Material:	PC	Dimension:	22.5x45mm
Rated Current:	16A	Voltage:	100V~240V AC
Wireless Standard:	Wi-Fi IEEE 802.11b/g/n 2.4GHz	Security System:	WPA-PSK/WPA2-PSK

Working Temperature and Humidity:

Environmental requirements: -10°C~+40°C 20%~90%RH
Storage temperature and humidity: -20°C~+85°C 10%~95%RH

LV-FBS-43: Smart switch, two module size



Model:	FBS-43	Color:	White
Material:	PC	Dimension:	45x45mm
Rated Current:	16A	Voltage:	100V~240V AC
Wireless Standard:	Wi-Fi IEEE 802.11b/g/n 2.4GHz	Security System:	WPA-PSK/WPA2-PSK

Working Temperature and Humidity:

Environmental requirements: -10°C~+40°C 20%~90%RH
Storage temperature and humidity: -20°C~+85°C 10%~95%RH

Features

- Color Available: White and Black (Can be supplied in any RAL color to meet your requirements. Subject to MOQ)
- Available Surface Finish: Matte Glossy
- Pre-wired switch.

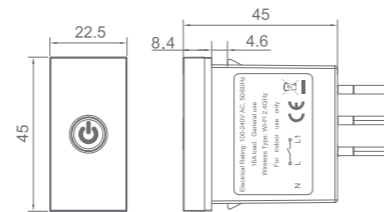

Features

- Color Available: White and Black (Can be supplied in any RAL color to meet your requirements. Subject to MOQ)
- Available Surface Finish: Matte Glossy
- Screw terminals.

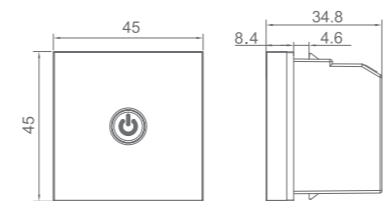

TYPE 45 SERIES DATA AND MULTIMEDIA MODULES



APP REMOTE CONTROL

Control your devices wirelessly from anywhere using the Tuya APP on your smartphone.



HANDS-FREE VOICE CONTROL

Works seamlessly with Amazon Alexa, Google Assistant and IFTTT to control your lights, plugs and other devices.



SET SCHEDULES/TIMERS

Create scheduled timers to automatically turn on/off your home appliances based on your preferences.

Data and images constitute no commitment whatsoever. We reserve the right to modify the contents of this document without prior notice on the basis of technical product developments.

TYPE 45 SERIES DATA AND MULTIMEDIA MODULES

LV-FBS-10: Blanking plates, one module size



Model	Material	Dimension (mm)
FBS-10	PC	22.5x45

Working Temperature and Humidity:

Environmental requirements: -10°C~+40°C 20%~90%RH
Storage temperature and humidity: -20°C~+85°C 10%~95%RH

Features

- Colors Available: White and Black (Can be supplied in any RAL color to meet your requirements. Subject to MOQ)
- Available Surface Finish: Matte Glossy
- Blanking plates.

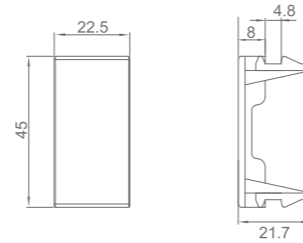

Features

- Colors Available: White and Black (Can be supplied in any RAL color to meet your requirements. Subject to MOQ)
- Available Surface Finish: Matte Glossy
- F12(Cat 5e): RJ45 socket with shutter.
- F12(Cat 6): Cat6/6A RJ45 socket with shutter.

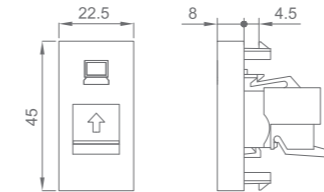

TYPE 45 SERIES DATA AND MULTIMEDIA MODULES

LV-FBS-CAT6: RJ45 socket with shutter

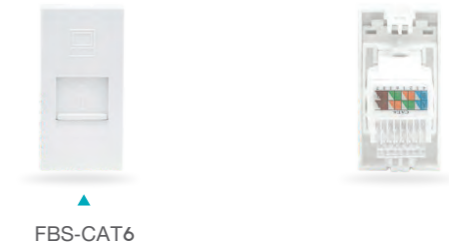

Model	Material	Dimension (mm)
F12(Cat 6/6A)	PC	22.5x45

Working Temperature and Humidity:

Environmental requirements: -10°C~+40°C 20%~90%RH
Storage temperature and humidity: -20°C~+85°C 10%~95%RH

LV-FBS-10D: Blanking plates, two module size



Model	Material	Dimension (mm)
FBS-10D	PC	45x45

Working Temperature and Humidity:

Environmental requirements: -10°C~+40°C 20%~90%RH
Storage temperature and humidity: -20°C~+85°C 10%~95%RH

Features

- Colors Available: White and Black (Can be supplied in any RAL color to meet your requirements. Subject to MOQ)
- Available Surface Finish: Matte Glossy
- Blanking plates.

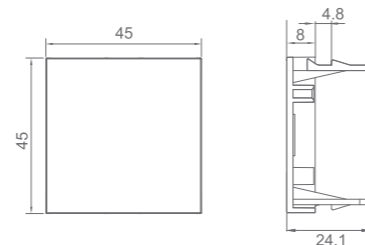

Features

- Colors Available: White and Black (Can be supplied in any RAL color to meet your requirements. Subject to MOQ)
- Available Surface Finish: Matte Glossy

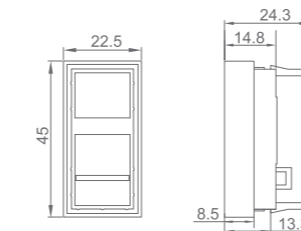

LV-FBS-A1: Adaptor for RJ45/RJ11 connector with window and shutter



Model	Material	Dimension (mm)
FBS-A1	PC	22.5x45

Working Temperature and Humidity:

Environmental requirements: -10°C~+40°C 20%~90%RH
Storage temperature and humidity: -20°C~+85°C 10%~95%RH

LV-FBS-TL: RJ11 telephone socket with shutter



Model	Material	Dimension (mm)
FBS-TL	PC	22.5x45

Working Temperature and Humidity:

Environmental requirements: -10°C~+40°C 20%~90%RH
Storage temperature and humidity: -20°C~+85°C 10%~95%RH

Features

- Colors Available: White and Black (Can be supplied in any RAL color to meet your requirements. Subject to MOQ)
- Available Surface Finish: Matte Glossy
- RJ11 telephone socket with shutter.
- Regular with 4 contacts.
- Special request for 2 contacts or 6 contacts on demand.

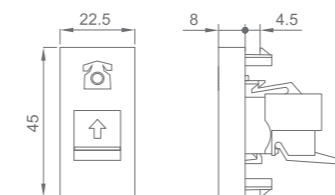

Features

- Colors Available: White and Black (Can be supplied in any RAL color to meet your requirements. Subject to MOQ)
- Available Surface Finish: Matte Glossy
- Adaptor for RJ45/RJ11 connector with window and shutter.

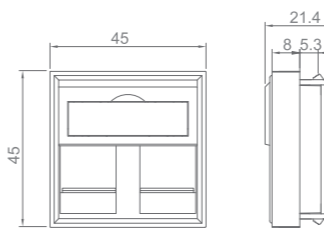

LV-FBS-A1D: Adaptor for RJ45/RJ11/ connector with window and shutter



Model	Material	Dimension (mm)
FBS-A1D	PC	45x45

Working Temperature and Humidity:

Environmental requirements: -10°C~+40°C 20%~90%RH
Storage temperature and humidity: -20°C~+85°C 10%~95%RH

TYPE 45 SERIES DATA AND MULTIMEDIA MODULES

LV-FBS-F12R-cat6: UTP CAT6 RJ45 socket with shutter

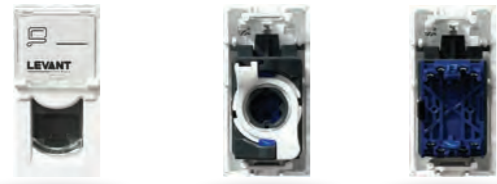

FBS-F12R-cat6

Model	Material	Dimension (mm)
FBS-F12R-cat6	PC	22.5X45

Working Temperature and Humidity:

Environmental requirements: -10°C~+40°C 20%~90%RH
Storage temperature and humidity: -20°C~+85°C 10%~95%RH

LV-FBS-F12ES-cat6: UTP CAT6 RJ45 socket with shutter



FBS-F12ES-cat6

Model	Material	Dimension (mm)
FBS-F12ES-cat6	PC	45x45

Working Temperature and Humidity:

Environmental requirements: -10°C~+40°C 20%~90%RH
Storage temperature and humidity: -20°C~+85°C 10%~95%RH

Features

- Colors Available: White (Can be supplied in any RAL color to meet your requirements. Subject to MOQ)
- Available Surface Finish: Matte Glossy
- Adaptor for RJ45 connector with shutter.

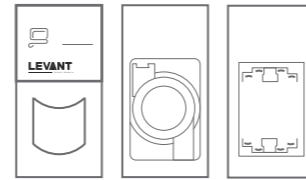

Features

- Colors Available: White (Can be supplied in any RAL color to meet your requirements. Subject to MOQ)
- Available Surface Finish: Matte Glossy
- Adaptor for RJ45 connector with shutter.

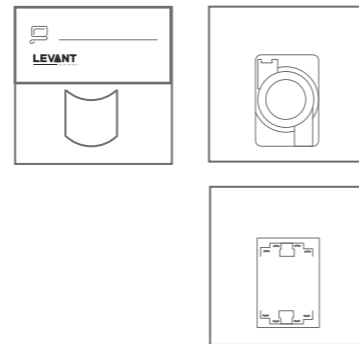

Features

- Colors Available: White and Black (Can be supplied in any RAL color to meet your requirements. Subject to MOQ)
- Available Surface Finish: Matte Glossy
- Adaptor for RJ45/RJ11 connector with window.

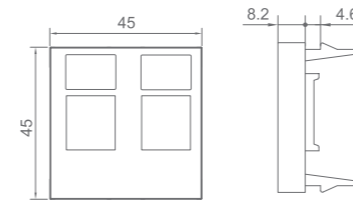

Features

- Colors Available: White and Black (Can be supplied in any RAL color to meet your requirements. Subject to MOQ)
- Available Surface Finish: Matte Glossy
- Adaptor for RJ45/RJ11 connector with window and shutter.

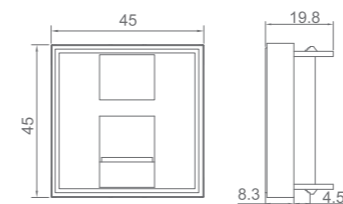

Features

- Colors Available: White and Black (Can be supplied in any RAL color to meet your requirements. Subject to MOQ)
- Available Surface Finish: Matte Glossy
- Cable exit.

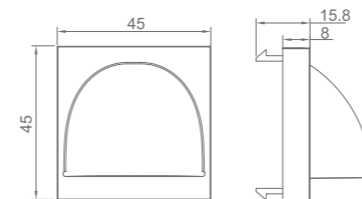

TYPE 45 SERIES DATA AND MULTIMEDIA MODULES

Adaptor for RJ45/RJ11/HDMI/USB connector with window



Model	Material	Dimension (mm)
	PC	45x45

Working Temperature and Humidity:

Environmental requirements: -10°C~+40°C 20%~90%RH
Storage temperature and humidity: -20°C~+85°C 10%~95%RH

Adaptor for RJ45/RJ11 connector with window and shutter



Model	Material	Dimension (mm)
	PC	45x45

Working Temperature and Humidity:

Environmental requirements: -10°C~+40°C 20%~90%RH
Storage temperature and humidity: -20°C~+85°C 10%~95%RH

Cable exit



Model	Material	Dimension (mm)
	PC	45x45

Working Temperature and Humidity:

Environmental requirements: -10°C~+40°C 20%~90%RH
Storage temperature and humidity: -20°C~+85°C 10%~95%RH

TYPE 45 SERIES DATA AND MULTIMEDIA MODULES

USB 2.0 data socket, soldering connection



Features

- Colors Available: White and Black (Can be supplied in any RAL color to meet your requirements. Subject to MOQ)
- Available Surface Finish: Matte Glossy
- Soldering connection.

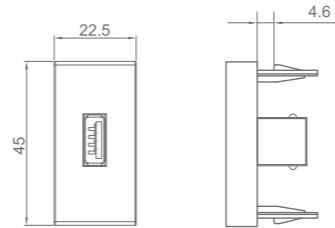

Model	Material	Dimension (mm)
	PC	22.5x45

Working Temperature and Humidity:

Environmental requirements: -10°C~+40°C 20%~90%RH
Storage temperature and humidity: -20°C~+85°C 10%~95%RH

USB 2.0 data socket, screw terminals



Features

- Colors Available: White and Black (Can be supplied in any RAL color to meet your requirements. Subject to MOQ)
- Available Surface Finish: Matte Glossy
- Screw terminals.

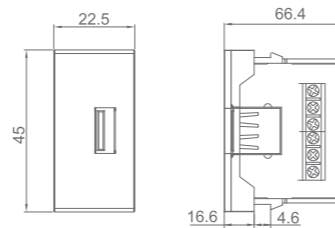

Model	Material	Dimension (mm)
	PC	22.5x45

Working Temperature and Humidity:

Environmental requirements: -10°C~+40°C 20%~90%RH
Storage temperature and humidity: -20°C~+85°C 10%~95%RH

USB 3.0 data socket, Female to Female connector



Features

- Colors Available: White and Black (Can be supplied in any RAL color to meet your requirements. Subject to MOQ)
- Available Surface Finish: Matte Glossy
- Female to Female connector.

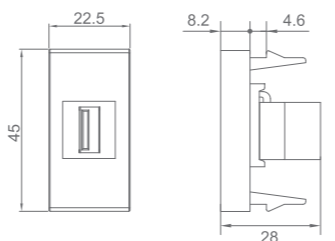

Model	Material	Dimension (mm)
	PC	22.5x45

Working Temperature and Humidity:

Environmental requirements: -10°C~+40°C 20%~90%RH
Storage temperature and humidity: -20°C~+85°C 10%~95%RH

Features

- Colors Available: White and Black (Can be supplied in any RAL color to meet your requirements. Subject to MOQ)
- Available Surface Finish: Matte Glossy
- Female VGA socket.
- 15 contacts.
- Soldering connection.

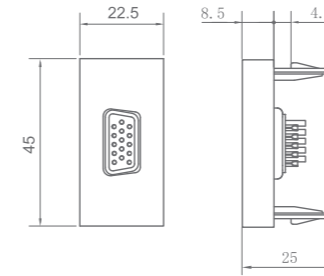

TYPE 45 SERIES DATA AND MULTIMEDIA MODULES

LV-FBS-VGAF: Female VGA socket, soldering connection



FBS-VGAF

Model	Material	Dimension (mm)
FBS-VGAF	PC	22.5x45

Working Temperature and Humidity:

Environmental requirements: -10°C~+40°C 20%~90%RH
Storage temperature and humidity: -20°C~+85°C 10%~95%RH

LV-FBS-VGAM: Male VGA socket, soldering connection



FBS-VGAM

Model	Material	Dimension (mm)
FBS-VGAM	PC	22.5x45

Working Temperature and Humidity:

Environmental requirements: -10°C~+40°C 20%~90%RH
Storage temperature and humidity: -20°C~+85°C 10%~95%RH

Features

- Colors Available: White and Black (Can be supplied in any RAL color to meet your requirements. Subject to MOQ)
- Available Surface Finish: Matte Glossy
- Male VGA socket.
- 15 contacts.
- Soldering connection.

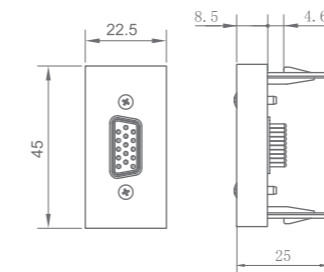

LV-FBS-HDMI: HDMI socket, one module size



FBS-HDMI

Model	Material	Dimension (mm)
FBS-HDMI	PC	22.5x45

Working Temperature and Humidity:

Environmental requirements: -10°C~+40°C 20%~90%RH
Storage temperature and humidity: -20°C~+85°C 10%~95%RH

Features

- Colors Available: White and Black (Can be supplied in any RAL color to meet your requirements. Subject to MOQ)
- Available Surface Finish: Matte Glossy
- Female to Female connector.

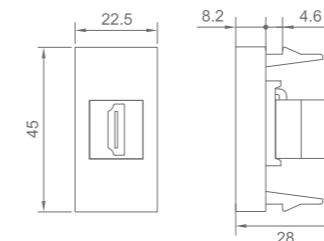

TYPE 45 SERIES DATA AND MULTIMEDIA MODULES

HDMI socket, two module size



Model	Material	Dimension (mm)
	PC	45x45

Working Temperature and Humidity:

Environmental requirements: -10°C~+40°C 20%~90%RH
Storage temperature and humidity: -20°C~+85°C 10%~95%RH

Pre-terminated HDMI socket, two module size



Model	Material	Dimension (mm)
	PC	45x45

Working Temperature and Humidity:

Environmental requirements: -10°C~+40°C 20%~90%RH
Storage temperature and humidity: -20°C~+85°C 10%~95%RH

Ø3.5mm jack connector for stereo connection



Model	Material	Dimension (mm)
	PC	22.5x45

Working Temperature and Humidity:

Environmental requirements: -10°C~+40°C 20%~90%RH
Storage temperature and humidity: -20°C~+85°C 10%~95%RH

Features

- Colors Available: White and Black (Can be supplied in any RAL color to meet your requirements. Subject to MOQ)
- Available Surface Finish: Matte Glossy
- Female to Female connector.

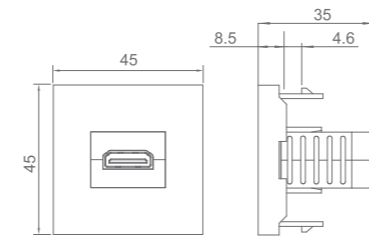

Features

- Colors Available: White and Black (Can be supplied in any RAL color to meet your requirements. Subject to MOQ)
- Available Surface Finish: Matte Glossy
- Pre-terminated HDMI socket.
- Equipped with 15cm length cord.

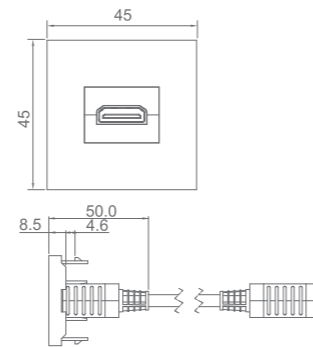

Features

- Colors Available: White and Black (Can be supplied in any RAL color to meet your requirements. Subject to MOQ)
- Available Surface Finish: Matte Glossy
- Ø3.5 jack connector for audio.
- Screw terminals.

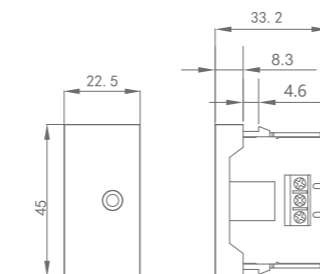

Features

- Colors Available: White and Black (Can be supplied in any RAL color to meet your requirements. Subject to MOQ)
- Available Surface Finish: Matte Glossy
- Impedance: 4 Ω
- Frequency Range: 120Hz~18KHz
- Signal-to-noise Ratio: ≥95dB
- Bluetooth Version: 5.0
- Approval: RF

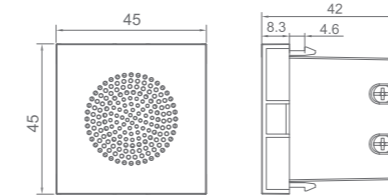

Features

- Colors Available: White and Black (Can be supplied in any RAL color to meet your requirements. Subject to MOQ)
- Available Surface Finish: Matte Glossy
- Impedance: 4 Ω
- Frequency Range: 120Hz~18KHz
- Signal-to-noise Ratio: ≥95dB
- Bluetooth Version: 5.0
- With microphone & switch

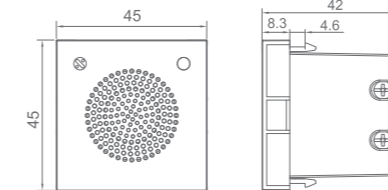

Features

- Colors Available: White and Black (Can be supplied in any RAL color to meet your requirements. Subject to MOQ)
- Available Surface Finish: Matte Glossy
- Impedance: 4 Ω
- Frequency Range: 120Hz~18KHz
- Signal-to-noise Ratio: ≥95dB
- Bluetooth Version: 5.0
- With microphone & switch
- Support dual channel stereo when two units are paired.

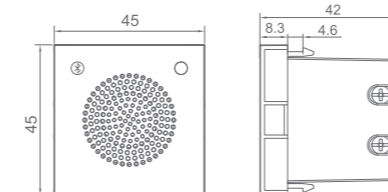

TYPE 45 SERIES DATA AND MULTIMEDIA MODULES

LV-FBS-BTS: Bluetooth speaker module



Model	Material	Voltage	Speaker Power	Operating Range	Dimension (mm)
FBS-BTS	PC	100V~240V AC	3W	10 meters(33 feet)	45x45

Working Temperature and Humidity:

Environmental requirements: -10°C~+40°C 20%~90%RH
Storage temperature and humidity: -20°C~+85°C 10%~95%RH

LV-FBS-BTSM: Bluetooth speaker module, with microphone & switch



Model	Material	Voltage	Speaker Power	Operating Range	Dimension (mm)
FBS-BTSM	PC	100V~240V AC	3W	10 meters(33 feet)	45x45

Working Temperature and Humidity:

Environmental requirements: -10°C~+40°C 20%~90%RH
Storage temperature and humidity: -20°C~+85°C 10%~95%RH

LV-FBS-BTSDC: Bluetooth speaker module, support dual channel stereo



Model	Material	Voltage	Speaker Power	Operating Range	Dimension (mm)
FBS-BTSDC	PC	100V~240V AC	3W	10 meters(33 feet)	45x45

Working Temperature and Humidity:

Environmental requirements: -10°C~+40°C 20%~90%RH
Storage temperature and humidity: -20°C~+85°C 10%~95%RH

Data and images constitute no commitment whatsoever. We reserve the right to modify the contents of this document without prior notice on the basis of technical product developments.

