

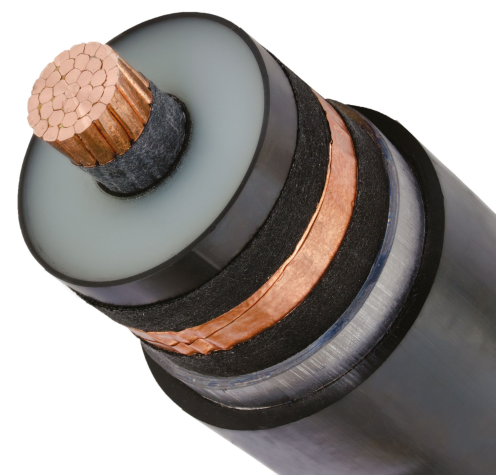

POWER CABLES

PROVIDING SAFE ENERGY





This catalogue provides technical information of overhead conductors and electrical power cables up to 220 kV, which helps our valued customers to select the desired cable for their needs.

The enclosed information guides customers to define the suitable cable design, voltage, ampacity, short circuit current in addition to approximate weight and dimension of the finished cable.



Index

05	General information & technical data
27	Overhead conductors
45	High Temperature Low Sag (HTLS) Conductors
57	Low Voltage Cables
109	Medium Voltage Cables
141	High & Extra High Voltage Cables
151	Handling & Laying Instruction
157	Type Test Approvals
161	Certifications
163	Our Partners
164	Esewedy Cables Contacts



Elsewedy Electric

75 years ago, we started with a clear vision to position Elsewedy Electric for successful growth, inspired by innovation, determination and spirit of hardworking staff, empowered and liberated by a strong enterprise system.

Since Elsewedy Electric started, we made the decision to never sacrifice integrity for growth; this same motto did not change till today... Behind our success is a professional dedicated team and latest technologies which deliver comprehensive product portfolio and unmatched services. Elsewedy Electric always delivers top-rated products and services customers need with the best results they deserve. Our creative solutions help corporations and organizations to quickly adapt to new technologies that enhance business productivity and enable them to stay ahead of the competition.

At Elsewedy Electric, we focus on three pillars of sustainability: Human, Environment, and Technology. We are working to produce the best products and offer a wider selection of solutions in order to meet growing energy demands.

We are striving to reduce our impact on the environment, conserve natural resources, and reducing our operating costs in the process.

Our heritage, as an energy solutions provider, runs deep. What began with Elsewedy Cables more than 30 years ago and became Elsewedy Electric has transformed into a global diversified company with more than 10,000 employees and 30 production facilities.

We are one of the top Energy Solutions companies in Middle East and Africa operating in 5 diversified energy segments; Cables & Accessories, Electrical Products, Energy Measurement & Management, Transformers, Engineering & Construction.

We are proud of what we have achieved so far but recognize that there is much work to be done to meet the aggressive goals we have set for ourselves. Elsewedy Electric has the capacity and the will to lead. We will continue to work and fight for those things that make the world a better place.

We remain dedicated to penetrate new markets with a vision of providing the best products and services to our clients and shareholders and create a good working environment for our employees. That's Performance with purpose. That's what every business owner should strive for.



Elsewedy Cables

One of the major companies under the umbrella of Elsewedy Electric holding company; it is also considered the mother company of the Cables Segment.

Elsewedy Cables is one of the leading worldwide manufacturers producing a wide range of cable, wires, special cables, fire resistance cables, fiber optic cables, network cables, cables accessories and integrated solutions. The company has been able to maximize its commitment to improve efficiency by ensuring that its management possesses the expertise and talent necessary for the most critical business needs and has thus succeeded in maintaining a solid financial position.

Dedicating an area over 34316m² and more than 900 employees for serving the complete process of the instrumentation, control, fire alarm, fire resistant cables, coaxial, LAN cables and winding wires manufacturing. Our production facilities are among the most advanced in the region offering value added products, resulting in a total annual production capacities of 20,000 ton/ annum.







General Information

Power Cable Selection:

The following factors are important for selecting the suitable cable construction:

- Voltage designation.
- Load factor.
- Required load (ampere or MVA).
- Level of short circuit current (KA) and duration (Sec).
- Environmental conditions.
- Laying conditions.

Standards:

Products described in this catalog are standard types and in accordance with the recommendation of IEC publications wherever applicable.

Power cables in accordance to other standards (BS, HD, NEMA, ASTM, AEIC, ICEA, VDE, DIN,.... etc.) or according to customer specification.

A) Standards Related to Power Cables

IEC Standards

S/N	No. of IEC	Subject
1	60028	International standard of resistance for copper.
2	60060	High-voltage test techniques
3	60104	Aluminum-magnesium-silicon alloy wire for overhead line conductors
4	60121	Recommendation for commercial annealed aluminum electrical conductor wire.
5	60173	Colours of the cores of flexible cables and cores.
6	60183	Guide to the selection of high voltage cables.
7	60227	Polyvinyl chloride insulated cables of rated voltage up to and including 450/750 V
8	60228	Conductors of insulated cables.
9	60229	Electric cables – Tests on extruded oversheaths with a special protective function
10	60230	Impulse tests on cables and their accessories.
11	60270	High-Voltage test techniques – Partial discharge measurements
12	60287	Electric cables - Calculation of the current rating.
13	60304	standard colors for insulation for low-frequency cables and wires
14	60331	Tests for electric cables under fire conditions - Circuit integrity
15	60332	Tests on electric and optical fibre cables under fire conditions
16	60502-1	Power cables with extruded insulation and their accessories for rated voltages from 1 kV (Um = 1,2 kV up to 30 kV (Um = 36 kV) - Part 1: Cables for rated voltages of 1 kV (Um = 1,2 kV) and 3 kV (Um = 3,6 kV)
17	60502-2	Power cables with extruded insulation and their accessories for rated voltages from 1 kV (Um = 1,2 kV) up to 30 kV (Um = 36 kV) – Part 2: Cables for rated voltages from 6 kV (Um = 7,2 kV) up to 30 kV (Um = 36 kV)
18	60719	Calculation of the lower and upper limits for the average outer dimensions of cables with circular copper conductors and of rated voltages up to and including 450/750 V.
19	60724	Short-circuit temperature limits of electric cables with rated voltages of 1kV (Um=1.2 kV) and 3 kV (Um=3.6 kV).
20	60754	Test on gases evolved during combustion of materials from cables.
21	60811	Electric and optical fibre cables - Test methods for non-metallic materials.
22	60840	Power cables with extruded insulation and their accessories for rated voltages above 30 kV (Um = 36 kV) up to 150 kV (Um = 170 kV) – Test methods and requirements.
23	60853	Calculation of the cyclic and emergency current rating of cables

» Cont'd

A) Standards Related to Power Cables

IEC Standards

S/N	No. of IEC	Subject
24	60865	Short circuit currents - calculation of effects
25	60885	Electrical test methods for electric cables.
26	60888	Zinc-Coated steel wires for stranded conductors
27	60889	Hard drawn aluminum wire for overhead line conductors
28	60949	Calculation of thermally permissible short-circuits currents, taking into account non-adiabatic heating effects.
29	60986	Short-circuit temperature limits of electric cables with rated voltages from 6kV (Um=7.2 kV) and to 30 kV (Um=36 kV).
30	61034	Measurement of smoke density of cables burning under defined conditions.
31	61089	Round wire concentric lay overhead electrical stranded conductors
32	61232	Aluminum – clad steel wires for electrical purposes.
33	61394	Overhead lines - Characteristics of greases for aluminum, aluminum alloy and steel bare conductors.
34	61443	Short circuit temperature limits of electric cables with rated voltages above 30 kV (Um=36 kV).
35	61597	Overhead electrical conductors – calculation methods for stranded bare conductors.
36	TR 61901	Tests recommended on cables with a longitudinally applied metal foil for rated voltages above 30 kV (Um = 36 kV) up to and including 500 kV (Um = 550 kV).
37	62067	Power cables with extruded insulation and their accessories for rated voltages above 150 kV (Um = 170 kV) up to 500 kV (Um = 550 kV) – Test methods and requirements.
38	62095	Electric Cables –Calculations for current ratings – Finite element method.
39	62230	Electric cables – Spark-test method
40	62440	Electric cables with a rated voltage not exceeding 450/750 V - Guide to use.

A) Standards Related to Power Cables

BS Standards

S/N	No. of BS	Subject
1	2627	Wrought aluminum for electrical purposes. Wire.
2	4553	600/1000 V single-phase split concentric electric cables.
3	5467	Thermosetting insulated, armoured cables of rated voltages of 600/1000 V and 1900/3 300 V for fixed installations. Specification
4	6231	Electric cables – Single core PVC insulated flexible cables of rated voltage 600/1000V for switchgear and control gear wiring
5	6387	Test method for resistance to fire of cables required to maintain circuit integrity under fire conditions
6	6485	PVC-covered conductors for overhead power lines. equipment intended for domestic, office and similar environments
7	6622	Electric cables - Armoured cables with thermosetting insulation for rated voltages from 3.8/6.6kV to 19/33kV - Requirements and test methods.
8	6724	Thermosetting insulated, armoured cables of rated voltages of 600/1000 V and 1900/3 300 V for fixed installations, having low emission of smoke and corrosive gases when affected by fire. Specification
9	7655	Specification for insulating and sheathing materials for cables.
10	7671	Requirements for Electrical Installations
11	7835	Armoured cables with thermosetting insulation for rated voltages from 3.8/6.6 kV to 19/33 kV having low emission of smoke and corrosive gases when affected by fire. Requirements and test methods
12	7846	Thermosetting insulated, armoured, fire-resistant cables of rated voltage 600/1 000 V for fixed installations, having low emission of smoke and corrosive gases when affected by fire. Specification
13	7870	LV and MV polymeric insulated cables for use by distribution and generation utilities.
14	7884	Copper and copper-cadmium stranded conductors for overhead electric traction and power transmission systems.
15	7889	Thermosetting insulated, non-armoured cables with a voltage of 600/1 000 V, for fixed installations.
16	8573	Thermosetting insulated, non-armoured cables with a voltage of 600/1 000V, for fixed installations, having low emissions of smoke and corrosive gases when affected by fire
17	EN 10244	Steel wire and wire products - Non-ferrous metallic coatings on steel wire

» Cont'd

A) Standards Related to Power Cables

BS Standards

S/N	No. of BS	Subject
18	EN 10257	Zinc or zinc alloy coated non-alloy steel wire for armouring either power cables or telecommunication cables
19	EN 50182	Conductors for overhead lines - Round wire concentric lay stranded conductors
20	EN 50183	Conductors for overhead lines - Aluminum - magnesium - silicon alloy wires
21	EN 50189	Conductors for overhead lines - Zinc coated steel wires
22	EN 50288	Multi-element metallic cables used in analogue and digital communication and control-
23	EN 50363	Insulating, sheathing and covering materials for low voltage energy cables
24	EN 50397	covered conductors for overhead lines and the related accessories for rated voltages above 1 kV a.c. and not exceeding 36 kV a.c.
25	EN 50525-1	Low voltage energy cables of rated voltages up to and including 450/750 V (U0/U). General requirements
26	EN 50525-2-12	Low voltage energy cables of rated voltages up to and including 450/750 V (U0/U). Cables for general applications. Cables with thermoplastic PVC insulation for extensible leads
27	EN 50525-2-21	Low voltage energy cables of rated voltages up to and including 450/750 V (U0/U). Cables for general applications. Flexible cables with crosslinked elastomeric insulation
28	EN 50525-2-31	Low voltage energy cables of rated voltages up to and including 450/750 V (U0/U). Cables for general applications. Single core non-sheathed cables with thermoplastic PVC insulation
29	EN 50525-2-41	Low voltage energy cables of rated voltages up to and including 450/750 V (U0/U). Cables for general applications. Single core cables with crosslinked silicone rubber insulation
30	EN 50525-2-42	Low voltage energy cables of rated voltages up to and including 450/750 V (U0/U). Cables for general applications. Single core non-sheathed cables with crosslinked EVA insulation
31	EN ISO 9001	Quality management systems – Requirements

A) Standards Related to Power Cables

HD Standards

S/N	No. of HD	Subject
1	HD 21	Polyvinyl chloride insulated cables of rated voltages up to and including 450/750 V.
2	HD 308	Identification of cores in cables and flexible cords.
3	HD 603	Distribution cables of rated voltage 0.6/1 kV
4	HD 604	0.6/1 kV and 1.9/3.3 kV power cables with special fire performance for use in power stations.
5	HD 605	Electric cables -Additional test methods
6	HD 620	Distribution cables with extruded insulation for rated voltages from 3.6/6 (7.2) kV up to and including 20.8/36 (42) kV
7	HD 622	Power cables having rated voltages from 3.6/6 (7.2) kV up to and including 20.8/36 (42) kV with special fire performance for use in power stations.
8	HD 626	Overhead distribution cables of rated voltage U ₀ /U (U _m): 0.6/1 (1.2) kV
9	HD 627	Multi-core and multi-pair cable for insulation above and below ground.
10	HD 632	Power cables with extruded insulation and their accessories for rated voltages above 36 kV (U _m = 42 kV) up to 150 kV (U _m = 170 kV)

IEEE Standards

S/N	No. of IEEE	Subject
1	IEEE 738	Standard for Calculating the Current-Temperature Relationship of Bare Overhead Conductors
2	IEEE 635	Guide for Selection and Design of Aluminum Sheaths for Power Cables
3	IEEE 532	Guide for Selecting and Testing Jackets for Power, Instrumentation, and Control Cables
4	IEEE 1242	Guide for Specifying and Selecting Power, Control, and Special-Purpose Cable for Petroleum and Chemical Plants
5	IEEE 1142	Guide for the Selection, Testing, Application, and Installation of Cables having Radial-Moisture Barriers and/or Longitudinal Water Blocking
6	IEEE 1202	Standard for Flame-Propagation Testing of Wire & Cable
7	IEEE 575	Guide for Bonding Shields and Sheaths of Single-Conductor Power Cables Rated 5 kV through 500 kV
8	IEEE 576	Recommended Practice for Installation, Termination, and Testing of Insulated Power Cable as Used in Industrial and Commercial Applications

A) Standards Related to Power Cables

NF Standards

S/N	No. of NF	Subject
1	C33-226	Insulated cables and their accessories for power systems - Cross-linked polyethylene cables of rated voltages from 6/10 (12) kV up to 18/30 (36) kV with fixed gradient for distribution networks
2	C32-321	Insulated cables and conductors for installations - Rigid cross-linked polyethylene insulated cables covered with a polyvinylchloride sheath - Series U-1000 R2V and U-1000 AR2V

B) Definitions

Definitions of dimensional values:

1. Nominal value:

Value by which a quantity is designated and which is often used in tables.

NOTE: Usually, in IEC standard, nominal values give rise to values to be checked by measurements taking into account specified tolerances.

2. Approximate value:

Value which is neither guaranteed nor checked, it is used, for example, for the calculation of other dimensional values.

3. Median Value:

When several test results have been obtained and ordered in an increasing (or decreasing) succession, the median value is the middle value if the number of available values is odd, and the mean of the two middle values if the number is even.

Definitions concerning the tests:

1. Routine tests:

Tests made by the manufacturer on each manufactured length of cable to check that each length meets the specified requirements.

2. Sample tests:

Tests made by the manufacturer on samples of completed cable or components taken from a completed cable, at a specified frequency, so as to verify that the finished product meets the specified requirements.

3. Type tests:

Tests made before supplying, on a general commercial basis, a type of cable covered by the standard, in order to demonstrate satisfactory performance characteristics to meet the intended application.

NOTE: These tests are of such nature that, after they have been made, they need not be repeated, unless changes are made in the cable materials or design or manufacturing process which might change the performance characteristics.

4. Prequalification test:

Test made before supplying, on a general commercial basis, a type of cable system covered by the standard, in order to demonstrate satisfactory long term performance of the complete cable system.

5. Extension of Prequalification Test:

Test made before supplying, on a general commercial basis, a type of cable system covered by the standard, in order to demonstrate satisfactory long term performance of the complete cable system taking into account an already prequalification cable system

6. Electrical tests after installation:

Tests made to demonstrate the integrity of the cable and its accessories as installed.

C) Voltage designation:

U₀: The rated r.m.s. power frequency voltage between each conductor and screen or sheath for which cables and accessories are designed.

U_m: The maxim r.m.s. power frequency voltage between any two conductors for which cables and accessories are designed. It is the highest voltage that can be sustained under normal operating conditions at any time and in any point in a system.

U: The rated r.m.s. power frequency voltage between any two conductors for which cables and accessories are designed.

Cables are designed by **U₀/U (U_m)** to provide guidance on compatibility with switchgear and transformers.

The following table gives the relation between **U₀**, **U**, and **U_m** in accordance with IEC 60183:

Rated voltage of cable (U₀)	Nominal system voltage (U)			Highest voltage for equipment (U_m)
kV	kV			kV
0.45	0.75			
0.6	1			1.2
1.8	3			3.6
3	3			3.6
3.5	6			7.2
6	6			7.2
6	10			12
8.7	10			12
8.7	15			17.5
12	20			24
18	30		33	36
26	45		47	52
36	60	66	69	72.5
64	110		115	123
76	132		138	145
87	150		161	170
127	220		230	245

D) Technical data & Cables parameters:

1. Resistance

The conductor DC resistance values given in this catalog are based on 20°C. In case of the conductor DC resistance is required at different temperature, the following formula shall be used:

$$R_{\theta} = R_{20} [1 + \alpha(\theta - 20)] \text{ } \Omega/\text{Km}$$

where

R_{θ}	: conductor DC resistance at $\theta^{\circ}\text{C}$	Ω/Km
R_{20}	: conductor DC resistance at 20°C	Ω/Km
θ	: operating temperature	$^{\circ}\text{C}$
α	: temperature coefficient	$1/^{\circ}\text{C}$
	= 0.00393 for Copper	
	= 0.00403 for Aluminum	

To get AC resistance of the conductor at operating temperature the following formula is used

$$R_{AC} = R_{\theta} (1 + Y_p + Y_s) \text{ } \Omega/\text{Km}$$

where

Y_p and Y_s are proximity and skin effect factors respectively

2. Inductance:

The self and mutual inductances are formulated as following:

$$L = K + 0.2 \ln\left(\frac{2S}{d}\right) \text{ } \text{mh}/\text{Km}$$

where

L	: Inductance	mh/Km
K	: Constant (as self inductance)	
d	: Conductor diameter	mm
S	: Axial spacing between cables in trefoil and in case of flat formation multiply the spacing by 1.26	mm

3. capacitance:

The capacitance is formulated as following:

$$C = \frac{\epsilon_r}{18 \ln\left(\frac{D}{d}\right)} \text{ } \mu\text{f}/\text{Km}$$

where

C	: Capacitance	$\mu\text{f}/\text{Km}$
ϵ_r	: relative permittivity of insulation material	
D	: Diameter over Insulation	mm
d	: Diameter under insulation	mm

4. Insulation resistance:

The insulation resistance is formulated as following:

$$R = K \ln(D/d) \text{ } \text{M}\Omega/\text{Km}$$

where

R	: insulation resistance	$\text{M}\Omega/\text{Km}$
K	: Constant depending on the insulation material	
d	: diameter under the insulation	mm
D	: diameter over the insulation	mm

5. Charging Current:

The charging current is the capacitive current which flows through the dielectric layers when AC voltage is applied. The value can be calculated from the following equation:

$$I_c = U_0 \omega C 10^{-6} \text{ } \text{A}/\text{Km}$$

where

I_c	: Charging current	A/Km
U_0	: Rated phase voltage	V
ω	: Angular of velocity ($2\pi f$)	
f	: Frequency	Hz
C	: Capacitance	$\mu\text{f}/\text{Km}$

6. Dielectric losses

The dielectric losses of an AC cable are proportional to the capacitance, the frequency, the phase voltage squared and the power factor. The value can be derived from the following equation:

$$W_d = \omega C U_0^2 \tan \delta 10^{-6} \text{ } \text{watt}/\text{Km}/\text{phase}$$

where

W_d	: Dielectric losses	$\text{watt}/\text{Km}/\text{phase}$
f	: Frequency	Hz
C	: Capacitance	$\mu\text{f}/\text{Km}$
U_0	: Rated phase voltage	V
$\tan \delta$: Dielectric power factor	
ω	: Angular of velocity ($2\pi f$)	

D) Technical data & Cables parameters:

7. Cable Ampacity:

Cable ampacity or current carrying capacity is defined as the continuous maximum current that cable can carry at its maximum operating temperature. The following installation conditions were assumed for the enclosed cable ampacity:

- Ambient air temperature 30(shaded) °C
- Ground temperature 20 °C
- Ground thermal resistivity 100 K.cm/Watt
- Burial depth 0.5 m
- Inner diameter of duct is 1.5 multiplied by outer cable diameter/ diameter of cables group
- Drying out of the soil is ignored.

- In case of installation conditions are different from the assumption stated. Derating factors tabulated in tables 3 to 11 shall be used for calculating the required current capacity.
- All cables ampacities are based on IEC 60287

8. Cable short circuit capacity:

Tables 13-17 give the short circuit current for both copper and aluminum conductor insulated by PVC & XLPE in accordance to table 13.

If the short circuit is required at duration not mentioned in the catalog, it is obtained by the following formula:

$$I_{s.c.t} = \frac{I_{s.c.1}}{\sqrt{t}} \quad \text{KA}$$

where

- $I_{s.c.t}$: short circuit current for t second KA
- $I_{s.c.1}$: short circuit current for 1 second KA
- t : duration Sec

9. Voltage drop:

When current flows in a cable there is a voltage drop between the ends of the cable which is the product of the current and the impedance.

the following equations should be used to calculate the voltage drop.

A. Single phase circuit

$$V_d = 2I\ell(R \cos\phi + X \sin\phi) \quad \text{v}$$

B. Three phase circuit

$$Vd=\sqrt{3}I\ell(R \cos\phi+X \sin\phi) \quad \text{v}$$

where

- V_d : Voltage drop V
- I : Load current A
- R : AC resistance Ω/Km
- X : Reactance Ω/Km
- $\text{Cos}\phi$: Power factor
- ℓ : Length Km
- $X = \omega L^{10-3}$ Ω/Km

L : Inductance

Relation between $\text{Cos}\phi$ & $\text{Sin}\phi$

Cos ϕ	1.0	0.9	0.8	0.71	0.6	0.5
Sin ϕ	0.0	0.44	0.6	0.71	0.8	0.87

- LV cable systems should be designed so as not to exceed voltage drop 3-5 % in normal operating conditions.

- Voltage drop data for LV cable (single & multi-core) are tabulated in tables 18 & 19.

10. Frequency:

Values in this catalog are based on 50 HZ frequency.

11. Load factor:

It is defined as the average power divided by the peak power, over a period of time.

In this catalog current values are calculated based on unity load factor.

E) Electrical and physical properties of Metals:

Electrical properties

Table 1

Metal	IACS 100 %	Electric alresistivity @ 20 °C Ω.m (10-8)	temperature coefficient of resistance per °C
Copper (annealed)	100	1.7241	0.00393
Copper (hard drawn)	97	1.777	0.00393
Tinned copper	95-97	1.741-1.814	0.00393
Aluminum	61	2.8264	0.00403
Lead	8	21.4	0.004

Electrical properties

Table 2

Property	Units	Copper	Aluminum	Lead
Density @ 20 °C	Kg/m ³	8890	2703	11340
Coeff. Of thermal expansion	1/°C X	17	23	29
Melting point	10 ⁻⁶ °C	1083	659	327
Thermal conductivity	W/cm °C	3.8	2.4	0.34
Ultimate tensile strength	Mn/mm ²	225	70-90	---

E) Derating Factors:

Air temperature derating factors

Table 3

Air temperature	15	20	25	30	35	40	45	50	55
PVC cables rated 70°C	1.21	1.15	1.07	1	0.92	0.84	0.75	0.66	0.55
XLPE cables rated 90°C	1.15	1.1	1.05	1	0.95	0.9	0.84	0.78	0.72

Ground temprature derating factors

Table 4

Air temperature	15	20	25	30	35	40	45	50	55
PVC cables rated 70°C	1.05	1	0.95	0.89	0.84	0.77	0.71	0.63	0.55
XLPE cables rated 90°C	1.04	1	0.96	0.93	0.89	0.85	0.8	0.76	0.71

F) Derating Factors:

Burial depth de-rating factors

Table 5

Depth of laying m	Direct buried			Duct		
	Single core		Three cores	Single core		Three cores
	<= 185	> 185		<= 185	> 185	
0.5	1	1	1	1	1	1
0.6	0.98	0.98	0.99	0.98	0.98	0.99
0.8	0.96	0.94	0.96	0.96	0.95	0.97
1	0.94	0.92	0.94	0.94	0.92	0.96
1.25	0.92	0.9	0.92	0.92	0.9	0.94
1.5	0.91	0.88	0.91	0.91	0.89	0.93
1.75	0.9	0.86	0.9	0.9	0.88	0.92
2	0.89	0.85	0.89	0.89	0.87	0.91
2.5	0.88	0.83	0.88	0.88	0.85	0.9
3	0.87	0.81	0.87	0.87	0.84	0.89

Soil thermal resistivity de-rating factors

Table 6

soil thermal resistivity K.°C/watt	0.8	0.9	1	1.2	1.5	2	2.5	3
de-rating factors	1.1	1.05	1	0.92	0.83	0.73	0.66	0.6

PVC rated temperature de-rating factors

Table 7

Type of PVC rated temperature °C	70	90	105
De-rating factors for cable directly buried in ground	1	1.15	1.24
De-rating factors for cable in air	1	1.28	1.46
De-rating factors for cable in duct	1	1.2	1.34

Trefoil or flat formation De-rating factors for three single core cables laid direct in ground

Table 8





Number of circuits						
	Trefoil Formation			Flat Formation		
	Touching		Spacing = 0.15 m	Spacing = 0.3 m		
nr	Trefoil	Flat	Trefoil	Flat	Trefoil	Flat
2	0.77	0.8	0.82	0.85	0.88	0.91
3	0.66	0.69	0.73	0.76	0.8	0.83
4	0.6	0.63	0.68	0.71	0.74	0.77
5	0.56	0.59	0.64	0.67	0.72	0.75
6	0.53	0.57	0.61	0.64	0.7	0.73

*L= Spacing

F) Derating Factors:

Trefoil formation De-rating factors for multi-core core cables laid direct in ground

Table 9

Number of circuits								
	Trefoil Formation				Flat Formation			
	Touching		Spacing = 0.15 m		Spacing = 0.15 m		Spacing = 0.30 m	
nr	Trefoil	Flat	Trefoil	Flat	Trefoil	Flat	Trefoil	Flat
2	0.81	0.81	0.87	0.87	0.91	0.91		
3	0.69	0.70	0.76	0.78	0.82	0.84		
4	0.62	0.63	0.72	0.74	0.77	0.81		
5	0.58	0.60	0.66	0.70	0.73	0.78		
6	0.54	0.56	0.63	0.67	0.70	0.76		

*L= Spacing

Reduction factors for groups of more than one multi-core cable in air to be applied to the current-carrying capacity for one multi-core cable in free air

Table 10

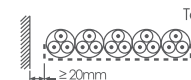
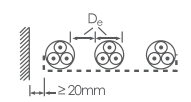
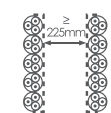
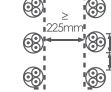
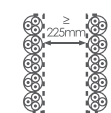
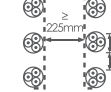
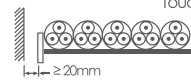
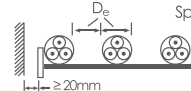
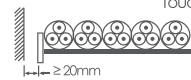
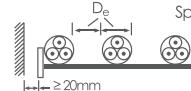
Number of trays	Number of cables						Method of installation
	1	2	3	4	6	9	
1	1.00	0.88	0.82	0.79	0.76	0.73	 Touching  Spaced
2	1.00	0.87	0.80	0.77	0.73	0.68	
3	1.00	0.86	0.79	0.76	0.71	0.66	
1	1.00	1.00	0.98	0.95	0.91	-	 Touching  Spaced
2	1.00	0.99	0.96	0.92	0.87	-	
3	1.00	0.98	0.95	0.91	0.85	-	
1	1.00	0.88	0.82	0.78	0.73	0.72	 Touching  Spaced
2	1.00	0.88	0.81	0.76	0.71	0.70	
1	1.00	0.91	0.89	0.88	0.87	-	
2	1.00	0.91	0.88	0.87	0.85	-	 Touching  Spaced
1	1.00	0.87	0.82	0.80	0.79	0.78	
2	1.00	0.86	0.80	0.78	0.76	0.73	
3	1.00	0.85	0.79	0.76	0.73	0.70	 Touching  Spaced
1	1.00	1.00	1.00	1.00	1.00	-	
2	1.00	0.99	0.98	0.97	0.96	-	
3	1.00	0.98	0.97	0.96	0.93	-	

- NOTE 1 Values given are averages for the cable types and range of conductor sizes considered. The spread of values is generally less than 5%
- NOTE 2 Factors apply to single layer groups of cables as shown above and do not apply when cables are installed in more than one layer touching each other. Values for such installations may be significantly lower and must be determined by an appropriate method.
- NOTE 3 Values are given for vertical spacing between trays of 300 mm and at least 20 mm between trays and wall. For closer spacing, the factors should be reduced.
- NOTE 4 Values are given for horizontal spacing between trays of 225 mm with trays mounted back to back. For closer spacing the factors should be reduced.

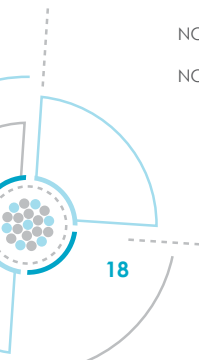

F) Derating Factors:

Reduction factors for groups of more than one circuit of single-core cables (note 2) to be applied to the current carrying capacity for one circuit of single-core cable in free air

Table 11

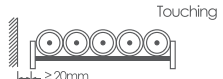
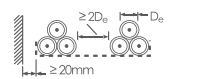
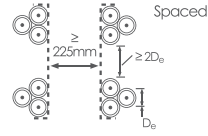
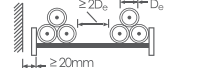
Number of trays	Number of cables			Use as a multiplier to rating for	Method of installation
	1	2	3		
1	0.98	0.91	0.87	Three cables in horizontal formation	Preforated trays (Note 3) 
2	0.96	0.87	0.81		
3	0.95	0.85	0.78		
1	1.00	0.97	0.96	Three cables in horizontal formation	Ladder supports, cleats, etc. (Note 3) 
2	0.98	0.93	0.89		
3	0.97	0.90	0.86		
1	1.00	0.98	0.96	Three cables in trefoil formation	Perforated trays (Note 3) 
2	0.97	0.93	0.98		
3	0.96	0.92	0.86		
1	1.00	0.91	0.89	Three cables in trefoil formation	Vertical perforated trays (Note 4) 
2	1.00	0.90	0.8		
1	1.00	1.00	1.00		
2	0.97	0.95	0.93	Ladder supports, cleats, etc. (Note 3)	
3	0.96	0.94	0.90		

- NOTE 1 Values given are averages for the cable types and range of conductor sizes considered. The spread of values is generally less than 5%
- NOTE 2 Factors are given for single layers of cables (or trefoil groups) as shown in the table and do not apply when cables are installed in more than one layer touching each other. Values for such installations may be significantly lower and should be determined by an appropriate method.
- NOTE 3 Values are given for vertical spacings between trays of 300 mm. For closer spacing, the factors should be reduced.
- NOTE 4 Values are given for horizontal spacing between trays of 225 mm with trays mounted back to back. For closer spacing, the factors should be reduced.
- NOTE 5 For circuits having more than one cable in parallel per phase, each three phase set of conductors should be considered as a circuit for the purpose of this table.

F) Derating Factors:

Minimum separation between cables in air to eliminate reduction

Table 12

Arrangement of Cables	Thermal proximity effect is negligible if e/D_e is greater than or equal to
1	2
Side by side	
2 multi-core	0.5
3 multi-core	0.75
2 trefoils	1
3 trefoils	1.5
one above the other	
2 multi-core	2
3 multi-core	4
2 trefoils	4
near to a vertical surface or to a horizontal surface below the cable	0.5

Max. Short circuit temperature for Cable components

Table 13

Material	Item	Temp. °C
Insulation	PVC insulation	140 For C.S.A > 300 mm ²
		160 For C.S.A ≤ 300 mm ²
	XLPE insulation	250
Jacket	PVC sheathing	200
	LLDPE sheathing	150
	HDPE sheathing	180
Metal	Lead sheath	170
	Lead sheath - alloy	200*
	Copper	250
	Aluminum	250

* Temp. = 210 °C for cables with rated voltages above 30kV ($U_m = 36$ kV).

Short Circuit Current

Short Circuit current in kA for Copper Conductors PVC insulated

Table 14

CSA mm ²	Duration in second									
	0.1	0.2	0.3	0.4	0.5	1	2	3	4	5
1.5	0.5	0.4	0.3	0.3	0.2	0.2	0.1	0.1	0.1	0.1
2.5	0.9	0.6	0.5	0.5	0.4	0.3	0.2	0.2	0.1	0.1
4	1.5	1	0.8	0.7	0.7	0.5	0.3	0.3	0.2	0.2
6	2.2	1.5	1.3	1.1	1	0.7	0.5	0.4	0.3	0.3
10	3.6	2.6	2.1	1.8	1.6	1.2	0.8	0.7	0.6	0.5
16	5.8	4.1	3.4	2.9	2.6	1.8	1.3	1.1	0.9	0.8
25	9.1	6.4	5.2	4.5	4.1	2.9	2	1.7	1.4	1.3
35	12.7	9	7.3	6.4	5.7	4	2.8	2.3	2	1.8
50	18.2	12.9	10.5	9.1	8.1	5.8	4.1	3.3	2.9	2.6
70	25.5	18	14.7	12.7	11.4	8.1	5.7	4.6	4	3.6
95	34.5	24.4	19.9	17.3	15.5	10.9	7.7	6.3	5.5	4.9
120	43.6	30.9	25.2	21.8	19.5	13.8	9.8	8	6.9	6.2
150	54.6	38.6	31.5	27.3	24.4	17.3	12.2	10	8.6	7.7
185	67.3	47.6	38.8	33.6	30.1	21.3	15	12.3	10.6	9.5
240	87.3	61.7	50.4	43.6	39	27.6	19.5	15.9	13.8	12.3
300	109.1	77.1	63	54.6	48.8	34.5	24.4	19.9	17.3	15.4
400	130	92	75.1	65	58.2	41.1	29.1	23.7	20.6	18.4
500	162.5	114.9	93.8	81.3	72.7	51.4	36.3	29.7	25.7	23
630	204.8	144.8	118.2	102.4	91.6	64.8	45.8	37.4	32.4	29
800	260.1	183.9	150.2	130	116.3	82.2	58.2	47.5	41.1	36.8

Short Circuit current in kA for Copper Conductors XLPE insulated

Table 15

CSA mm ²	Duration in second									
	0.1	0.2	0.3	0.4	0.5	1	2	3	4	5
1.5	0.7	0.5	0.4	0.3	0.3	0.2	0.2	0.1	0.1	0.1
2.5	1.1	0.8	0.7	0.6	0.5	0.4	0.3	0.2	0.2	0.2
4	1.8	1.3	1	0.9	0.8	0.6	0.4	0.3	0.3	0.3
6	2.7	1.9	1.6	1.4	1.2	0.9	0.6	0.5	0.4	0.4
10	4.5	3.2	2.6	2.3	2	1.4	1	0.8	0.7	0.6
16	7.2	5.1	4.2	3.6	3.2	2.3	1.6	1.3	1.1	1
25	11.3	8	6.5	5.7	5.1	3.6	2.5	2.1	1.8	1.6
35	15.8	11.2	9.1	7.9	7.1	5	3.5	2.9	2.5	2.2
50	22.6	16	13.1	11.3	10.1	7.2	5.1	4.1	3.6	3.2
70	31.7	22.4	18.3	15.8	14.2	10	7.1	5.8	5	4.5
95	43	30.4	24.8	21.5	19.2	13.6	9.6	7.8	6.8	6.1
120	54.3	38.4	31.3	27.1	24.3	17.2	12.1	9.9	8.6	7.7
150	67.9	48	39.2	33.9	30.4	21.5	15.2	12.4	10.7	9.6
185	83.7	59.2	48.3	41.9	37.4	26.5	18.7	15.3	13.2	11.8
240	108.6	76.8	62.7	54.3	48.6	34.3	24.3	19.8	17.2	15.4
300	135.7	96	78.4	67.9	60.7	42.9	30.4	24.8	21.5	19.2
400	181	128	104.5	90.5	80.9	57.2	40.5	33	28.6	25.6
500	226.2	160	130.6	113.1	101.2	71.5	50.6	41.3	35.8	32
630	285.1	201.6	164.6	142.5	127.5	90.1	63.7	52	45.1	40.3
800	362	256	209	181	161.9	114.5	80.9	66.1	57.2	51.2

Short Circuit Current

Short Circuit current in kA for Aluminum Conductors PVC insulated

Table 16

CSA mm ²	Duration in second									
	0.1	0.2	0.3	0.4	0.5	1	2	3	4	5
1.5	0.4	0.3	0.2	0.2	0.2	0.1	0.1	0.1	0.1	0.1
2.5	0.6	0.4	0.3	0.3	0.3	0.2	0.1	0.1	0.1	0.1
4	1	0.7	0.6	0.5	0.4	0.3	0.2	0.2	0.2	0.1
6	1.4	1	0.8	0.7	0.6	0.5	0.3	0.3	0.2	0.2
10	2.4	1.7	1.4	1.2	1.1	0.8	0.5	0.4	0.4	0.3
16	3.8	2.7	2.2	1.9	1.7	1.2	0.9	0.7	0.6	0.5
25	6	4.3	3.5	3	2.7	1.9	1.3	1.1	1	0.9
35	8.4	6	4.9	4.2	3.8	2.7	1.9	1.5	1.3	1.2
50	12	8.5	6.9	6	5.4	3.8	2.7	2.2	1.9	1.7
70	16.8	11.9	9.7	8.4	7.5	5.3	3.8	3.1	2.7	2.4
95	22.8	16.2	13.2	11.4	10.2	7.2	5.1	4.2	3.6	3.2
120	28.9	20.4	16.7	14.4	12.9	9.1	6.5	5.3	4.6	4.1
150	36.1	25.5	20.8	18	16.1	11.4	8.1	6.6	5.7	5.1
185	44.5	31.5	25.7	22.2	19.9	14.1	9.9	8.1	7	6.3
240	57.7	40.8	33.3	28.9	25.8	18.2	12.9	10.5	9.1	8.2
300	72.1	51	41.6	36.1	32.3	22.8	16.1	13.2	11.4	10.2
400	86	60.2	49.6	43	38.5	27.2	19.2	15.7	13.6	12.2
500	107.5	76	62.1	53.7	48.1	34	24	19.6	17	15.2
630	135.4	95.8	78.2	67.7	60.6	42.8	30.3	24.7	21.4	19.2
800	172	121.6	99.3	86	76.9	54.4	38.5	31.4	27.2	24.3

Short Circuit current in kA for Aluminum Conductors XLPE insulated





Table 17





CSA mm ²	Duration in second									
	0.1	0.2	0.3	0.4	0.5	1	2	3	4	5
1.5	0.4	0.3	0.3	0.2	0.2	0.1	0.1	0.1	0.1	0.1
2.5	0.7	0.5	0.4	0.4	0.3	0.2	0.2	0.1	0.1	0.1
4	1.2	0.8	0.7	0.6	0.5	0.4	0.3	0.2	0.2	0.2
6	1.8	1.3	1	0.9	0.8	0.6	0.4	0.3	0.3	0.3
10	3	2.1	1.7	1.5	1.3	0.9	0.7	0.5	0.5	0.4
16	4.8	3.4	2.8	2.4	2.1	1.5	1.1	0.9	0.8	0.7
25	7.5	5.3	4.3	3.7	3.3	2.4	1.7	1.4	1.2	1.1
35	10.5	7.4	6	5.2	4.7	3.3	2.3	1.9	1.7	1.5
50	14.9	10.6	8.6	7.5	6.7	4.7	3.3	2.7	2.4	2.1
70	20.9	14.8	12.1	10.5	9.4	6.6	4.7	3.8	3.3	3
95	28.4	20.1	16.4	14.2	12.7	9	6.3	5.2	4.5	4
120	35.9	25.4	20.7	17.9	16	11.3	8	6.5	5.7	5.1
150	44.8	31.7	25.9	22.4	20	14.2	10	8.2	7.1	6.3
185	55.3	39.1	31.9	27.6	24.7	17.5	12.4	10.1	8.7	7.8
240	71.7	50.7	41.4	35.9	32.1	22.7	16	13.1	11.3	10.1
300	89.6	63.4	51.8	44.8	40.1	28.3	20	16.4	14.2	12.7
400	119.5	84.5	69	59.8	53.4	37.8	26.7	21.8	18.9	16.9
500	149.4	105.6	86.3	74.7	66.8	47.2	33.4	27.3	23.6	21.1
630	188.2	133.1	108.7	94.1	84.2	59.5	42.1	34.4	29.8	26.6
800	239	169	138	119.5	106.9	75.6	53.4	43.6	37.8	33.8

Voltage Drop

Voltage drop for single core L.V. cables

Table 18

CSA mm ²	Copper Conductor Voltage Drop (mv / AMP / Meter)			
	PVC Insulation & PVC Sheathed		XLPE Insulation & PVC Sheathed	
	Flat 	Trefoil 	Flat 	Trefoil 
4	7.830	7.770	8.337	8.277
6	5.287	5.226	5.628	5.568
10	3.184	3.124	3.401	3.341
16	2.068	2.008	2.203	2.142
25	1.357	1.297	1.440	1.380
35	1.034	0.971	1.085	1.024
50	0.793	0.732	0.836	0.776
70	0.595	0.534	0.624	0.564
95	0.469	0.408	0.490	0.430
120	0.410	0.349	0.417	0.357
150	0.354	0.294	0.366	0.305
185	0.312	0.252	0.322	0.262
240	0.272	0.211	0.278	0.218
300	0.247	0.187	0.253	0.192
400	0.224	0.164	0.220	0.159
500	0.208	0.148	0.211	0.150
630	0.194	0.134	0.191	0.131

CSA mm ²	Aluminium Conductor Voltage Drop (mv / AMP / Meter)			
	PVC Insulation & PVC Sheathed		XLPE Insulation & PVC Sheathed	
	Flat 	Trefoil 	Flat 	Trefoil 
16	3.343	3.283	3.561	3.500
25	2.161	2.100	2.296	2.235
35	1.602	1.542	1.700	1.640
50	1.222	1.162	1.291	1.230
70	0.890	0.830	0.937	0.877
95	0.686	0.623	0.719	0.655
120	0.569	0.509	0.594	0.534
150	0.490	0.430	0.511	0.451
185	0.420	0.360	0.437	0.377
240	0.353	0.293	0.367	0.307
300	0.312	0.252	0.322	0.262
400	0.274	0.214	0.278	0.218
500	0.245	0.185	0.260	0.199
630	0.222	0.162	0.223	0.163

The above data are based on:
 - Max. operating temp: 90 °C for XLPE & 70 °C for PVC
 - Power factor: 0.8 Rated frequency: 50 HZ
 - Cables are touched in flat formation

Voltage Drop

Voltage Drop for Multi core L.V Cables

Table 19

CSA mm ²	Copper Conductor Voltage Drop (mv / AMP / Meter)	
	PVC Insulation & PVC Sheathed	XLPE Insulation & PVC Sheathed
1.5	20.345	20.341
2.5	12.397	13.197
4	7.741	7.731
6	5.199	5.191
10	3.101	3.094
16	1.275	1.282
25	0.957	1.009
35	0.726	0.764
50	0.526	0.552
70	0.402	0.418
95	0.334	0.347
120	0.287	0.297
150	0.246	0.254
185	0.207	0.212
240	0.182	0.185
300	0.160	0.163
400	0.144	0.145

CSA mm ²	Aluminium Conductor Voltage Drop (mv / AMP / Meter)	
	PVC Insulation & PVC Sheathed	XLPE Insulation & PVC Sheathed
16	3.263	3.479
25	2.084	2.218
35	1.527	1.624
50	1.150	1.217
70	0.819	0.865
95	0.613	0.645
120	0.500	0.524
150	0.421	0.442
185	0.352	0.369
240	0.286	0.299
300	0.245	0.255
400	0.208	0.211

The above data are based on:
 Max. operating temp: 90 °C for XLPE & 70 °C for PVC
 Power factor : 0.8 Rated frequency: 50 HZ
 Cables are touched in flat formation

Conversion Table

Table 20

Multiply	By	To Obtain
Weight-Imperial		
Ounces	28.3495	grams
Pounds (Av)	453.59	grams
Pounds (Av)	0.45359	Kilograms
Tons (short)	907.19	Kilograms
Tons (long)	1016.05	Kilograms
Weight-Metric		
Grams	0.03527	Ounces
Grams	0.002205	Pounds
Kilograms	35.274	Ounces
Kilograms	2.2046	Pounds
Kilograms	0.001102	tons (short)
Kilograms	0.0009842	tons (long)
Miscellaneous-Imperial		
Pounds per 1000 feet	1.48816	Kg/Km
Pounds per mile	0.28185	Kg/Km
Pounds per square inch	0.0007031	Kg. per square mm.
Pounds per square inch	0.07031	Kg. per square cm.
Pounds per cubic	27.68	grams per cubic cm.
Feet per second	18.288	meters per minute.
Feet per second	1.09728	Kilometers per hour.
Miles per hour	1.60935	Kilometers per hour.
Ohms per 1000 feet	3.28083	ohms per Kilometer.
Ohms per mile	0.62137	ohms per Kilometer.
Decibels per 1000 feet	3.28083	decibels per Kilometer.
Decibels per mile	0.62137	decibels per Kilometer.
Decibels	0.1153	nepers.
Miscellaneous-Metric		
Kg/Km	0.67197	pounds per 1000 feet.
Kg/Km	3.54795	pounds per mile.
Kg.per square mm	1422.34	pounds per square inch.
Kg.per square cm	14.2234	pounds per square inch.
Grams per cubic cm	0.03613	pounds per cubic inch.
Meters per minute	0.05468	feet per second.
Kilometers per hour	0.91134	feet per second.
Kilometer per hour	0.62137	miles per hour.
Ohms per Kilometer	0.3048	ohms per 1000 feet.
Ohms per Kilometer	1.6093	ohms per mile.
Decibels per kilometer	0.3048	decibels per 1000 feet.
Decibels per kilometer	1.6093	decibels per mile.
Temperature		
° Fahrenheit	5/9(°F)-32	°Celsius
° Celsius	9/5(°C)+32	°Fahrenheit
Length-Imperial		
Mils	0.001	inches.
Mils	0.0254	mm.
Inches	1000	mils.

Multiply	By	To Obtain
Inches	25.40	mm.
Inches	2.54	cm.
Feet	30.48	cm.
Feet	0.3048	meters.
Feet (thousands of)	0.3048	kilometers.
Yards	0.9144	meters.
Miles	1.6093	kilometers
Length-Metric		
Millimeters	39.37	mils.
Millimeters	0.03937	inches.
Centimeters	0.3937	inches.
Centimeters	0.032808	feet.
Meters	39.37	inches.
Meters	3.2808	feet.
Meters	1.0936	yards.
Kilometers	3280.83	feet.
Kilometers	0.62137	miles.
Area-Imperial		
Square mils	1.2732	circular mils
Square mils	0.000001	square inches
Circular mils	0.7854	square mils
Circular mils	0.0000007854	square inches
Square mils	0.0005067	square mm.
Square inches	1000000	square mils
Square inches	1273240	circualr mils
Square inches	645.16	square mm.
Square inches	6.4516	square cm.
Square feet	0.09290	square meters
Square yards	0.8361	square meters
Area-Metric		
Square millimeters	1973.52	circular mils
Square millimeters	0.00155	square inches
Square centimeters	0.155	square inches
Square meters	10.7638	square feet
Square meters	1.19599	square yards
Volume-Imperial		
Cubic inches	16.38716	cubic cm.
Cubic feet	0.028317	cubic meters
Volume-U.S.		
Quarts (liquid)	0.9463	liters
Gallons	3.7854	liters.
Volume-Metric		
Cubic cm	0.06102	cubic inches.
Cubic meters	35.3145	cubic feet.
Liters	1.05668	quarts (liquid U.S)
Liters	0.26417	gallons (U.S.)





Overhead Conductors

Product Types

1. Bare Hard and Soft Drawn Copper Conductors.
2. All Aluminum Conductor (AAC)
3. All Aluminum Alloy Conductor (AAAC)
4. Aluminum Conductor Steel reinforced (ACSR)
5. Aluminum Conductor Aluminum Clad Steel reinforced (ACSR/AW)
6. Areal Bundled Cables (ABC)

Cable Construction:

1. Conductor

Copper, Aluminum, Aluminum Alloy conductors consist of wires concentrically applied in successive layers in opposite direction.

In case of ACSR conductor a core of solid or stranded galvanized steel is applied first.

2. Insulation

In case of areal bundled cables, an extruded layer of PVC or XLPE or HDPE with 2.5 % of carbon black as UV protector is applied upon the conductor.

Bare Copper Conductor



Hard drawn conductor:

Description

Plain bare hard drawn copper conductors as per DIN 48201.

Application

Hard drawn copper conductors are used in overhead electrical distribution networks.

Bare Hard Drawn

Product Code	Cross Sectional Area	Number and Nominal Diameter of Wires	Max. DC. resistance at 20°C	Approx. overall diameter	Calculated Breaking Load	Approx. Weight
	mm ²	No x Ø (mm)	Ω/Km	mm	KN	Kg/Km
CH0-T001-U10	10	7X1.35	1.829	4.1	4.02	90
CH0-T001-U11	16	7X1.7	1.154	5.1	6.37	143
CH0-T001-U12	25	7X2.1	0.7563	6.3	9.72	218
CH0-T001-U13	35	7X2.5	0.5337	7.5	13.77	310
CH0-T001-U14	50	7X3	0.3706	9	19.84	446
CH0-T001-U14	50	19X1.8	0.3819	9	19.38	437
CH0-T001-U15	70	19X2.1	0.2806	10.5	26.38	596
CH0-T001-U16	95	19X2.5	0.198	12.5	37.39	845
CH0-T001-U17	120	19X2.8	0.1578	14	46.9	1060
CH0-T001-U18	150	37X2.25	0.1264	15.8	58.96	1337
CH0-T001-U19	185	37X2.5	0.1024	17.5	72.81	1649
CH0-T001-U20	240	61X2.25	0.07528	20.3	97.23	2209
CH0-T001-U30	300	61X2.5	0.06097	22.5	120.04	2725
CH0-T001-U40	400	61X2.89	0.0456	26	160.42	3640
CH0-T001-U50	500	61X3.23	0.0365	29.1	200.38	4545

The above data is approximate and subjected to manufacturing tolerance.

Bare Copper Conductor



Soft drawn conductor:

Description

Plain bare soft drawn copper conductors as per IEC 60228 class 2.

Application

Soft drawn copper conductors are used for grounding electrical systems, where high conductivity and flexibility are required.

Bare Soft Drawn

Product Code	Cross Sectional Area	Minimum Number of wires	Max. DC. resistance at 20°C	Approx. overall diameter	Approx. Weight
	mm ²	No	Ω/Km	mm	Kg/Km
CS0-T001-U10	10	6	1.83	3.7	86.5
CS0-T001-U11	16	6	1.15	4.7	137
CS0-T001-U12	25	6	0.727	5.8	216
CS0-T001-U13	35	6	0.524	6.9	297
CS0-T001-U14	50	6	0.387	8.2	405
CS0-T001-U15	70	12	0.268	9.8	586
CS0-T001-U16	95	15	0.193	11.3	815
CS0-T001-U17	120	18	0.153	12.7	1035
CS0-T001-U18	150	18	0.124	14.1	1277
CS0-T001-U19	185	30	0.0991	15.8	1595
CS0-T001-U20	240	34	0.0754	18.2	2095
CS0-T001-U30	300	34	0.0601	20.6	2623
CS0-T001-U40	400	53	0.047	23.2	3385
CS0-T001-U50	500	53	0.0366	26.6	4370

The above data is approximate and subjected to manufacturing tolerance.

All Aluminum Conductors (AAC)



Description

Hard drawn Aluminum wires, stranded in successive layers, in opposite direction to form the Aluminum stranded AAC conductor, As per BS EN 50182 or IEC 61089.

Application

All Aluminum bare conductors are used for aerial distribution lines having relatively short spans, aerial feeders and bus bars of substations.

α- According to BS EN 50182 - Germany

Product Code	Cross Sectional Area	Number and Nominal Diameter of Wires	Max. DC. resistance at 20°C	Rated strength	Approx. overall diameter	Approx. Weight	Current carrying capacity
	mm ²	No x Ø (mm)	Ω/Km	KN	mm	Kg/Km	Amp
AA0-T001-U11	16	7X1.7	1.7986	3.02	5.1	43.4	110
AA0-T001-U12	25	7X2.1	1.1787	4.36	6.3	66.3	145
AA0-T001-U13	35	7X2.5	0.8317	6.01	7.5	93.9	180
AA0-T001-U14	50	7X3	0.5776	8.41	9	135.2	225
AA0-T001-U14	50	19X1.8	0.5944	8.94	9	132.9	225
AA0-T001-U15	70	19X2.1	0.4367	11.85	10.5	180.9	270
AA0-T001-U16	95	19X2.5	0.3081	16.32	12.5	256.3	340
AA0-T001-U17	120	19x2.8	0.2456	19.89	14	321.5	390
AA0-T001-U18	150	37X2.25	0.196	26.48	15.8	405.7	455
AA0-T001-U19	185	37X2.5	0.1588	31.78	17.5	500.9	520
AA0-T001-U20	240	61X2.25	0.1193	43.66	20.3	671.1	625
AA0-T001-U30	300	61X2.5	0.0966	52.4	22.5	828.5	710
AA0-T001-U40	400	61X2.89	0.0723	68.02	26	1107.1	855
AA0-T001-U50	500	61X3.23	0.0579	82.47	29.1	1382.9	990
AA0-T001-U60	625	91X2.96	0.0464	106.45	32.6	1739.7	1140
AA0-T001-U70	800	91x3.35	0.0362	132.34	36.9	2228.3	1340
AA0-T001-U80	1000	91X3.74	0.0291	159.95	41.1	2777.3	1540

The above data is approximate and subjected to manufacturing tolerance.

Note:

Guideline values of current carrying capacity are valid up to 60 Hz, assuming an ambient temperature of 35 °C, final temperature of 80 °C wind velocity of 0.6 m/sec according to BSEN 50182 Germany Tables.

All Aluminum Conductors (AAC)



b- According to BS EN 50182 - United Kingdom

Product Code	Nominal cross sectional area	Number & nominal diameter of wires	Max. DC resistance at 20 °C	Rated strength	Approx. overall diameter	Approx. Weight	Current carrying capacity
	mm ²	No x Ø (mm)	Ω/Km	KN	mm	Kg/Km	Amp
MIDGE	23.3	7 x 2.06	1.2249	4.2	6.18	63.8	137
GNAT	26.9	7 x 2.21	1.0643	4.83	6.63	73.4	150
MOSQUITO	36.9	7 x 2.59	0.7749	6.27	7.77	100.8	183
LADYBIRD	42.8	7 x 2.79	0.6678	7.28	8.37	117	201
ANT	52.8	7 x 3.10	0.5409	8.72	9.3	144.4	230
FLY	63.6	7 x 3.40	0.4497	10.49	10.2	173.7	258
BLUEBOTTLE	73.6	7 x 3.66	0.3880	11.78	11	201.3	284
EARWIG	78.6	7 x 3.78	0.3638	12.57	11.3	214.7	296
GRASSHOPPER	84.1	7 x 3.91	0.3400	13.45	11.7	229.7	308
CLEGG	95.6	7 x 4.17	0.2989	15.3	12.5	261.3	335
WASP	106	7 x 4.39	0.2697	16.95	13.2	289.6	357
BEETLE	106.4	19 x 2.67	0.2701	18.08	13.4	292.4	358
BEE	132	7 x 4.90	0.2165	21.12	14.7	360.8	411
HORNET	157.6	19 x 3.25	0.1823	26.01	16.3	433.2	460
CATERPILLAR	185.9	19 x 3.53	0.1546	29.75	17.7	511.1	511
CHAFER	213.2	19 x 3.78	0.1348	34.12	18.9	586	558
SPIDER	237.6	19 x 3.99	0.1210	38.01	20	652.9	597
COCKROACH	265.7	19 x 4.22	0.1081	42.52	21.1	730	641
BUTTERFLY	322.7	19 x 4.65	0.0891	51.63	23.3	886.8	725
MOTH	373.1	19 x 5.00	0.0770	59.69	25	1025.3	795
DRONE	372.4	37 x 3.58	0.0774	59.59	25.1	1027.1	794
CENTIPEDE	415.2	37 x 3.78	0.0695	66.43	26.5	1145.1	850
MAYBUG	486.1	37 x 4.09	0.0593	77.78	28.6	1340.6	939
SCORPION	529.8	37 x 4.27	0.0544	84.77	29.9	1461.2	991
CICADA	628.3	37 x 4.65	0.0459	100.54	32.6	1732.9	1102

The above data is approximate and subjected to manufacturing tolerance.

Note:

Guideline values of current carrying capacity are valid up to 60 Hz, assuming an ambient temperature of 35 °C, final temperature of 80 °C wind velocity of 0.6 m/sec, sun radiation of 1000 W/m², emissivity of 0.5, absorption factor of 0.5

All Aluminum Alloy Conductors (AAAC)



Description

All Aluminum alloy (ALMELEC) conductors , stranded in successive layers to form the stranded AAAC conductor. As per IEC 61089 or BS EN 50182 or ASTM B 399.

Application

AAAC are mainly used for overhead lines , in transmission and distribution electrical networks , having relatively long spans. They are also used a messenger to support overhead electrical cables.

α- According to BS EN 50182 - Germany

Product Code	Cross Sectional Area	Number and Nominal Diameter of Wires	Max. DC. resistance at 20°C	Rated strength	Approx. overall diameter	Approx. Weight	Current carrying capacity
	mm ²	No x Ø (mm)	Ω/Km	KN	mm	Kg/Km	Amp
AA0-T001-U11	16	7X1.7	2.0701	4.69	5.1	43.4	105
AA0-T001-U12	25	7X2.1	1.3566	7.15	6.3	66.2	135
AA0-T001-U13	35	7X2.5	0.9572	10.14	7.5	93.8	170
AA0-T001-U14	50	7x3	0.6647	14.6	9	135.1	210
AA0-T001-U14	50	19X1.8	0.6841	14.26	9	132.7	210
AA0-T001-U15	70	19X2.1	0.5026	19.41	10.5	180.7	255
AA0-T001-U16	95	19X2.5	0.3546	27.51	12.5	256	320
AA0-T001-U17	120	19x2.8	0.2827	34.51	14	321.2	365
AA0-T001-U18	150	37X2.25	0.2256	43.4	15.8	405.3	425
AA0-T001-U19	185	37X2.5	0.1827	53.58	17.5	500.3	490
AA0-T001-U20	240	61X2.25	0.1373	71.55	20.3	670.3	585
AA0-T001-U30	300	61X2.5	0.1112	88.33	22.5	827.5	670
AA0-T001-U40	400	61X2.89	0.0832	118.04	26	1105.9	810
AA0-T001-U50	500	61X3.23	0.0666	147.45	29.1	1381.4	930
AA0-T001-U60	625	91X2.96	0.0534	184.73	32.6	1737.7	1075
AA0-T001-U70	800	91x3.35	0.0417	236.62	36.9	2225.8	1255
AA0-T001-U80	1000	91X3.74	0.0334	294.91	41.1	2774.3	1450

The above data is approximate and subjected to manufacturing tolerance.

Note:

Guideline values of current carrying capacity are valid up to 60 Hz, assuming an ambient temperature of 35 °C, final temperature of 80 °C wind velocity of 0.6 m/sec according to BSEN 50182 Germany Tables.

All Aluminum Alloy Conductors (AAAC)



b- According to BS EN 50182 - United Kingdom

Product Code	Cross Sectional Area	Number & nominal diameter of wires	Max. DC resistance at 20 °C	Rated strength	Approx. overall diameter	Approx. Weight	Current carrying capacity
	mm ²	No x Ø (mm)	Ω/Km	KN	mm	Kg/Km	Amp
BOX	18.8	7 x 1.85	1.7480	5.55	5.55	51.4	112
ACACIA	23.8	7 x 2.08	1.3828	7.02	6.24	64.9	130
ALMOND	30.1	7 x 2.34	1.0926	8.88	7.02	82.2	151
CEDAR	35.5	7 x 2.54	0.9273	10.46	7.62	96.8	168
DEODAR	42.2	7 x 2.77	0.7797	12.44	8.31	115.2	187
FIR	47.8	7 x 2.95	0.6875	14.11	8.85	130.6	202
HAZEL	59.9	7 x 3.30	0.5494	17.66	9.90	163.4	233
PINE	71.6	7 x 3.61	0.4591	21.14	10.8	195.6	261
HOLLY	84.1	7 x 3.91	0.3913	24.79	11.7	229.5	289
WILLOW	89.7	7 x 4.04	0.3665	26.47	12.1	245.0	301
OAK	118.9	7 x 4.65	0.2767	35.07	14.0	324.5	360
MULBERRY	150.9	19 x 3.18	0.2192	44.52	15.9	414.3	420
ASH	180.7	19 x 3.48	0.1830	53.31	17.4	496.1	471
ELM	211.0	19 x 3.76	0.1568	62.24	18.8	579.2	519
POPLAR	239.4	37 x 2.87	0.1387	70.61	20.1	659.4	562
SYCAMORE	303.2	37 x 3.23	0.1095	89.40	22.6	835.2	654
UPAS	362.1	37 x 3.53	0.0917	106.82	24.7	997.5	732
YEW	479.0	37 x 4.06	0.0693	141.31	28.4	1319.6	874
TOTARA	498.1	37 x 4.14	0.0666	146.93	29.0	1372.1	895
RUBUS	586.9	61 x 3.50	0.0567	173.13	31.5	1622.0	991
SORBUS	659.4	61 x 3.71	0.0505	194.53	33.4	1822.5	1066
ARAUCARIA	821.1	61 x 4.14	0.0406	242.24	37.3	2269.4	1221
REDWOOD	996.2	61 x 4.56	0.0334	293.88	41.0	2753.2	1373

The above data is approximate and subjected to manufacturing tolerance.

Note:

Guideline values of current carrying capacity are valid up to 60 Hz, assuming an ambient temperature of 35 °C, final temperature of 80 °C wind velocity of 0.6 m/sec, sun radiation of 1000 W/m², emissivity of 0.5, absorption factor of 0.5.

Aluminum Conductor Steel Reinforced (ACSR)



Description

An outer layer of Aluminum conductor concentrically stranded over the central core of galvanized solid or stranded steel wires to form Aluminum steel reinforced conductor. As per BS EN 50182 or ASTM B 232 or IEC 61089.

Application

ACSR conductors are widely used for electrical power transmission over long distance. It could be used as a messenger for supporting overhead electrical cables.

α- According to BS EN 50182 - Germany

Product Code	Cross Sectional Area	Number and Nominal Diameter of Wires		Max. DC. resistance at 20°C	Rated strength	Approx. overall diameter	Approx. Weight	Current carrying capacity
		Aluminum	Steel					
	mm ²	No x Ø (mm)		Ω/Km	KN	mm	Kg/Km	Amp
ACO-T001-U11	16/2.5	6 x 1.80	1x1.80	1.8769	5.80	5.4	5.4	105
ACO-T001-U12	25/4	6 x 2.25	1x2.25	1.2012	8.95	6.75	6.75	140
ACO-T001-U13	35/6	6 x 2.70	1x2.70	0.8342	12.37	8.1	8.1	170
ACO-T001-U14	50/8	6 x 3.20	1x3.20	0.5939	16.81	9.6	9.6	210
ACO-T001-U15	70/12	26 x 1.85	7x1.44	0.4132	26.27	11.7	11.7	290
ACO-T001-U16	95/15	26 x 2.15	7x1.67	0.3060	34.93	13.6	13.6	350
ACO-T001-U17	120/20	26 x 2.44	7x1.90	0.2376	44.50	15.5	15.5	410
ACO-T001-U18	150/25	26 x 2.70	7x2.10	0.1940	53.67	17.1	17.1	470
ACO-T001-U19	185/30	26 x 3.00	7x2.33	0.1571	65.27	19.0	19.0	535
ACO-T001-U21	210/35	26 x 3.20	7x2.49	0.1381	73.36	20.3	20.3	590
ACO-T001-U20	240/40	26 x 3.45	7x2.68	0.1188	85.12	21.8	21.8	645
ACO-T001-U31	380/50	54 x 3.00	7x3.00	0.0758	121.30	27.0	27.0	840
ACO-T001-U64	490/65	54 x 3.40	7x3.40	0.0590	150.81	30.6	30.6	960

The above data is approximate and subjected to manufacturing tolerance.

Note:

Guideline values of current carrying capacity are valid up to 60 Hz, assuming an ambient temperature of 35 °C, final temperature of 80 °C wind velocity of 0.6 m/sec according to BSEN 50182 Germany Tables.

Aluminum Conductor Steel Reinforced (ACSR)



b- According to BS EN 50182 - United Kingdom

Product Code	Cross Sectional Area		Number and Nominal Diameter of Wires		Max. DC. resistance at 20°C	Rated strength	Approx. overall diameter	Approx. Weight	Current carrying capacity
	Aluminum	Steel	Aluminum	Steel					
	mm ²		No x Ø (mm)						
MOLE	10.6	1.77	6 x 1.50	1 x 1.50	2.7027	4.14	4.50	42.8	79
SQUIRREL	21.0	3.50	6 x 2.11	1 x 2.11	1.3659	7.87	6.33	84.7	122
GOPHER	26.2	4.37	6 x 2.36	1 x 2.36	1.0919	9.58	7.08	106.0	140
WEASEL	31.6	5.27	6 x 2.59	1 x 2.59	0.9065	11.38	7.77	127.6	158
FOX	36.7	6.11	6 x 2.79	1 x 2.79	0.7812	13.21	8.37	148.1	173
FERRET	42.4	7.07	6 x 3.00	1 x 3.00	0.6757	15.27	9.00	171.2	190
RABBIT	52.9	8.81	6 x 3.35	1 x 3.35	0.5419	18.42	10.1	213.5	219
MINK	63.1	10.5	6 x 3.66	1 x 3.66	0.4540	21.67	11.0	254.9	245
SKUNK	63.2	36.9	12 x 2.59	7 x 2.59	0.4568	52.79	13.0	463.0	255
BEAVER	75.0	12.5	6 x 3.99	1 x 3.99	0.3820	25.76	12.0	302.9	273
HORSE	73.4	42.8	12 x 2.79	7 x 2.79	0.3936	61.26	14.0	537.3	280
RACCOON	78.8	13.1	6 x 4.09	1 x 4.09	0.3635	27.06	12.3	318.3	282
OTTER	83.9	14.0	6 x 4.22	1 x 4.22	0.3415	28.81	12.7	338.8	293
CAT	95.4	15.9	6 x 4.50	1 x 4.50	0.3003	32.76	13.5	385.3	318
HARE	105.0	17.5	6 x 4.72	1 x 4.72	0.2730	36.04	14.2	423.8	338
DOG	105.0	13.6	6 x 4.72	7 x 1.57	0.2733	32.65	14.2	394.0	338
COYOTE	131.7	20.1	26 x 2.54	7 x 1.91	0.2192	45.86	15.9	520.7	417
COUGAR	131.5	7.31	18 x 3.05	1 x 3.05	0.2188	29.74	15.3	418.8	413
TIGER	131.2	30.6	30 x 2.36	7 x 2.36	0.2202	57.87	16.5	602.2	421
WOLF	158.1	36.9	30 x 2.59	7 x 2.59	0.1829	68.91	18.1	725.3	474
DINGO	158.7	8.81	18 x 3.35	1 x 3.35	0.1814	35.87	16.8	505.2	465
LYNX	183.4	42.8	30 x 2.79	7 x 2.79	0.1576	79.97	19.5	841.6	521
CARACAL	184.2	10.2	18 x 3.61	1 x 3.61	0.1562	40.74	18.1	586.7	512
PANTHER	212.1	49.5	30 x 3.00	7 x 3.00	0.1363	92.46	21.0	973.1	571
JAGUAR	210.6	11.7	18 x 3.86	1 x 3.86	0.1366	46.57	19.3	670.8	550
LION	238.3	55.6	30 x 3.18	7 x 3.18	0.1213	100.47	22.3	1093.4	616
BEAR	264.4	61.7	30 x 3.35	7 x 3.35	0.1093	111.50	23.5	1213.4	658
GOAT	324.3	75.7	30 x 3.71	7 x 3.71	0.0891	135.13	26.0	1488.2	749
SHEEP	375.1	87.5	30 x 3.99	7 x 3.99	0.0771	156.30	27.9	1721.3	822
ANTELOPE	374.1	48.5	54 x 2.97	7 x 2.97	0.0773	118.88	26.7	1413.8	795
BISON	381.7	49.5	54 x 3.00	7 x 3.00	0.0758	121.30	27.0	1442.5	806
DEER	429.6	100.2	30 x 4.27	7 x 4.27	0.0673	179.00	29.9	1971.4	897
ZEBRA	428.9	55.6	54 x 3.18	7 x 3.18	0.0674	131.92	28.6	1620.8	868
ELK	477.1	111.3	30 x 4.50	7 x 4.50	0.0606	198.80	31.5	2189.5	959
CAMEL	476.0	61.7	54 x 3.35	7 x 3.35	0.0608	146.40	30.2	1798.8	928
MOOSE	528.5	68.5	54 x 3.53	7 x 3.53	0.0547	159.92	31.8	1997.3	992

The above data is approximate and subjected to manufacturing tolerance
Other types can be provided on specific request.

Note:

Guideline values of current carrying capacity are valid up to 60 Hz, assuming an ambient temperature of 35 °C, final temperature of 80 °C wind velocity of 0.6 m/sec, sun radiation of 1000 W/m², emissivity of 0.5, absorption factor of 0.5.

Aluminum Conductor Steel Reinforced (ACSR)



c- According to ASTM 232

Product Code	Cross Sectional Area		Number and Nominal Diameter of Wires		Max. DC. resistance at 20°C	Rated strength	Approx. overall diameter	Approx. Weight		Current carrying capacity
	Aluminum	Steel	Aluminum	Steel				Aluminum	Steel	
	mm ²		No x Ø (mm)					Ω/Km	KN	
GROUSE	40.5	14.12	8 x 2.54	1 x 4.24	0.7089	22.9	9.3	112	110	187
PETREL	51.6	30.1	12 x 2.34	7 x 2.34	0.5596	46.2	11.7	143	235	224
MINORCA	56.1	32.73	12 x 2.44	7 x 2.44	0.5146	50.2	12.2	156	256	236
LEGHORN	68.2	39.78	12 x 2.69	7 x 2.69	0.4234	60.5	13.5	189	311	268
GUINEA	80.4	46.88	12 x 2.92	7 x 2.92	0.3593	71.1	14.6	223	367	297
DOTTEREL	89.4	52.15	12 x 3.08	7 x 3.08	0.323	76.7	15.4	248	407	318
DORKING	96.5	56.3	12 x 3.20	7 x 3.20	0.2992	83.2	16	268	441	334
BRAHMA	102.8	91.78	16 x 2.86	19 x 2.48	0.2809	126.3	18.1	285	718	356
COCHIN	107	62.44	12 x 3.37	7 x 3.37	0.2698	91.8	16.9	297	488	357
TURKEY	13.3	2.22	6 x 1.68	1 x 1.68	2.1499	5.3	5	36	17	104
SWAN	21.2	3.53	6 x 2.12	1 x 2.12	1.3501	8.3	6.4	58	27	123
SWANATE	21.1	5.35	7 x 1.96	1 x 2.61	1.3539	10.5	6.5	58	42	123
SPARROW	33.6	5.6	6 x 2.67	1 x 2.67	0.8512	12.7	8	92	44	164
SPARATE	33.5	8.55	7 x 2.47	1 x 3.30	0.8525	16.1	8.3	92	67	165
ROBIN	42.4	7.07	6 x 3.00	1 x 3.00	0.6742	15.8	9	117	55	190
RAVEN	53.5	8.92	6 x 3.37	1 x 3.37	0.5343	19.4	10.1	147	69	220
QUAIL	67.3	11.22	6 x 3.78	1 x 3.78	0.4247	23.3	11.3	185	87	255
PIGEON	85.1	14.19	6 x 4.25	1 x 4.25	0.3359	29.4	12.8	233	110	296
PENGUIN	107.2	17.87	6 x 4.77	1 x 4.77	0.2667	37.1	14.3	294	139	342
WAXWING	135.0	7.5	18 x 3.09	1 x 3.09	0.2129	30.3	15.5	373	59	420
PARTRIDGE	134.9	21.99	26 x 2.57	7 x 2.00	0.2142	50.2	16.3	373	172	425
OSTRICH	152.2	24.7	26 x 2.73	7 x 2.12	0.1897	56.6	17.3	421	193	459
MERLIN	170.2	9.46	18 x 3.47	1 x 3.47	0.1688	38.2	17.4	470	74	487
LINNET	170.6	27.83	26 x 2.89	7 x 2.25	0.1693	62.8	18.3	472	217	494
ORIOLE	170.5	39.8	30 x 2.69	7 x 2.69	0.1698	77	18.8	473	311	562
CHICKADEE	200.9	11.16	18 x 3.77	1 x 3.77	0.1430	43.4	18.9	555	87	541
BRANT	201.6	26.13	24 x 3.27	7 x 2.18	0.1433	64.7	19.6	558	204	547
IBIS	201.3	32.73	26 x 3.14	7 x 2.44	0.1434	72.1	19.9	558	256	549
LARK	200.9	46.9	30 x 2.92	7 x 2.92	0.1442	90.3	20.4	559	367	552
PELICAN	242.3	13.46	18 x 4.14	1 x 4.14	0.1186	52.3	20.7	669	105	609

The above data is approximate and subjected to manufacturing tolerance
Other types can be provided on specific request.

[» Cont'd](#)

Note:

Guideline values of current carrying capacity are valid up to 60 Hz, assuming an ambient temperature of 35 °C, final temperature of 80 °C wind velocity of 0.6 m/sec, sun radiation of 1000 W/m², emissivity of 0.5, absorption factor of 0.5.

Aluminum Conductor Steel Reinforced (ACSR)



c- According to ASTM 232

Product Code	Cross Sectional Area		Number and Nominal Diameter of Wires		Max. DC. resistance at 20°C	Rated strength	Approx. overall diameter	Approx. Weight		Current carrying capacity
	Aluminum	Steel	Aluminum	Steel				Aluminum	Steel	
	mm ²		No x Ø (mm)					Ω/Km	KN	
FLICKER	241.6	31.4	24 x 3.58	7 x 2.39	0.1195	76.5	21.5	670	245	614
HAWK	241.6	39.2	26 x 3.44	7 x 2.67	0.1195	86.4	21.8	670	306	616
HEN	241.3	56.3	30 x 3.20	7 x 3.20	0.12	105.2	22.4	672	440	621
OSPREY	282.5	15.7	18 x 4.47	1 x 4.47	0.1017	61	22.4	779	122	672
PARAKEET	282.3	36.6	24 x 3.87	7 x 2.58	0.1023	88.3	23.2	782	285	678
DOVE	282.6	45.92	26 x 3.72	7 x 2.89	0.1022	101.1	23.6	784	359	681
EAGLE	282.1	65.82	30 x 3.46	7 x 3.46	0.1026	123	24.2	783	514	686
PEACOCK	306.1	39.8	24 x 4.03	7 x 2.69	0.0943	95.8	24.2	850	311	714
SQUAB	305.8	49.8	26 x 3.87	7 x 3.01	0.0945	108.1	24.5	849	390	716
WOODDUCK	307.1	71.65	30 x 3.61	7 x 3.61	0.0943	129	25.3	853	559	724
TEAL	307.1	69.62	30 x 3.61	19 x 2.16	0.0943	133.4	25.2	853	545	723
SWIFT	323	8.97	36 x 3.38	1 x 3.38	0.089	60.6	23.7	891	70	714
KINGBIRD	323	17.95	18 x 4.78	1 x 4.78	0.089	69.7	23.9	891	139	731
ROOK	323.1	41.9	24 x 4.14	7 x 2.76	0.0894	101	24.8	896	326	739
GROSBEAK	321.8	52.49	26 x 3.97	7 x 3.09	0.0897	111.9	25.2	893	409	740
SCOTER	322.6	75.26	30 x 3.70	7 x 3.70	0.0897	135.5	25.9	895	588	747
EGRET	322.6	73.54	30 x 3.70	19 x 2.22	0.0897	140.6	25.9	895	575	747
FLAMINGO	337.3	43.72	24 x 4.23	7 x 2.82	0.0856	105.4	25.4	936	342	759
GANNET	338.3	54.9	26 x 4.07	7 x 3.16	0.0854	117.2	25.8	936	429	764
STILT	363.3	46.88	24 x 4.39	7 x 2.92	0.0795	113.4	26.3	1005	367	796
STARLING	361.9	59.15	26 x 4.21	7 x 3.28	0.0798	126	26.7	1004	461	797
REDWING	362.1	82.41	30 x 3.92	19 x 2.35	0.08	153.7	27.4	1006	646	804
CUCKOO	402.3	52.15	24 x 4.62	7 x 3.08	0.0718	123.8	27.7	1116	408	850
DRAKE	402.6	65.44	26 x 4.44	7 x 3.45	0.0717	139.7	28.1	1117	511	853
TERN	403.8	27.83	45 x 3.38	7 x 2.25	0.0715	97.5	27	1115	217	829
COOT	401.9	11.16	36 x 3.77	1 x 3.77	0.0715	72.9	26.4	1111	87	821
CONDOR	402.3	52.15	54 x 3.08	7 x 3.08	0.0718	124.3	27.7	1115	407	833
MALLARD	403.8	91.78	30 x 4.14	19 x 2.48	0.0717	171.2	29	1119	718	861
RUDDY	455.5	31.67	45 x 3.59	7 x 2.40	0.0634	109.3	28.7	1263	246	896
CANARY	456.3	59.15	54 x 3.28	7 x 3.28	0.0633	141.9	29.5	1263	461	903

The above data is approximate and subjected to manufacturing tolerance
Other types can be provided on specific request.

» Cont'd

Note:

Guideline values of current carrying capacity are valid up to 60 Hz, assuming an ambient temperature of 35 °C, final temperature of 80 °C wind velocity of 0.6 m/sec, sun radiation of 1000 W/m², emissivity of 0.5, absorption factor of 0.5.

Aluminum Conductor Steel Reinforced (ACSR)



c- According to ASTM 232

Product Code	Cross Sectional Area		Number and Nominal Diameter of Wires		Max. DC. resistance at 20°C	Rated strength	Approx. overall diameter	Approx. Weight		Current carrying capacity
	Aluminum	Steel	Aluminum	Steel				Aluminum	Steel	
	mm ²		No x Ø (mm)					Ω/Km	KN	
RAIL	483.8	33.54	45 x 3.70	7 x 2.47	0.0597	116	29.6	1339	261	923
CATBIRD	484.6	13.46	36 x 4.14	1 x 4.14	0.0593	87.9	29	1335	105	919
CARDINAL	484.5	62.81	54 x 3.38	7 x 3.38	0.0596	149.7	30.4	1338	490	929
ORTOLAN	523.9	36.31	45 x 3.85	7 x 2.57	0.0551	123.3	30.8	1450	283	969
TANAGER	522.8	14.52	36 x 4.30	1 x 4.30	0.055	94.8	30.1	1444	113	963
CURLEW	522.5	67.73	54 x 3.51	7 x 3.51	0.0553	161.5	31.6	1450	529	975
BLUEJAY	565.5	38.9	45 x 4.00	7 x 2.66	0.0511	132.7	32	1568	304	1012
FINCH	565	71.57	54 x 3.65	19 x 2.19	0.0514	174.6	32.9	1574	560	1017
BUNTING	605.8	41.88	45 x 4.14	7 x 2.76	0.0477	142.4	33.1	1680	326	1057
GRACKLE	602.8	76.89	54 x 3.77	19 x 2.27	0.0481	184.2	34	1679	602	1059
BITTERN	644.4	44.66	45 x 4.27	7 x 2.85	0.0448	151.6	34.2	1786	348	1097
PHEASANT	645.1	81.71	54 x 3.90	19 x 2.34	0.045	194	35.1	1797	639	1106
SKYLARK	643.3	17.87	36 x 4.77	1 x 4.77	0.0447	117.2	33.4	1782	140	1088
DIPPER	684.2	47.2	45 x 4.40	7 x 2.93	0.0422	160.7	35.2	1882	370	1138
MARTIN	685.4	86.67	54 x 4.02	19 x 2.41	0.0423	206.1	36.2	1910	679	1146
BOBOLINK	725.2	50.14	45 x 4.53	7 x 3.02	0.0398	170.5	36.2	2010	392	1176
PLOVER	726.9	91.78	54 x 4.14	19 x 2.48	0.0399	218.4	37.2	2014	719	1184
NUTHATCH	746.2	52.83	45 x 4.65	7 x 3.10	0.0378	177.6	37.2	2120	413	1214
PARROT	766.1	97.03	54 x 4.25	19 x 2.55	0.038	230.5	38.2	2134	758	1220
LAPWING	807.5	55.6	45 x 4.78	7 x 3.18	0.0359	187.4	38.2	2239	435	1250
FALCON	806.2	102.43	54 x 4.36	19 x 2.62	0.036	243	39.3	2246	802	1260

The above data is approximate and subjected to manufacturing tolerance
Other types can be provided on specific request.

Note:

Guideline values of current carrying capacity are valid up to 60 Hz, assuming an ambient temperature of 35 °C, final temperature of 80 °C wind velocity of 0.6 m/sec, sun radiation of 1000 W/m², emissivity of 0.5, absorption factor of 0.5.

Aluminum Conductor Aluminum Clad Steel Reinforced (ACSR/AW)



Description

An outer layer of Aluminum conductor concentrically stranded over the central core of aluminum clad steel solid or stranded to form Aluminum Aluminum Clad Steel Reinforced conductor . As per ASTM B549.

Application

ACSR/AW conductors are used for electrical power transmission, they are ideal for long overhead lines spans like ACSR but with slightly better resistance and current carrying capacity in addition to good corrosion resistance.

According to ASTM 549

Product Code	Cross Sectional Area		Number and Nominal Diameter of Wires		Max. DC. resistance at 20°C	Rated strength	Approx. overall diameter	Approx. Weight	Current carrying capacity
	Aluminum	Steel	Aluminum	Steel					
	mm ²		No x Ø (mm)						
FALCON/AW	806	102.43	54x4.36	19x2.62	0.0345	236	39.26	2917	1310
LAPWING/AW	806	55.6	45x4.78	7x3.18	0.0351	186	38.22	2598	1288
PARROT/AW	765	97.03	54x4.25	19x2.55	0.0363	224	38.25	2768	1271
NUTHATCH/AW	765	52.83	45x4.65	7x3.10	0.0369	176	37.2	2467	1245
PLOVER/AW	725	91.78	54X4.14	19X2.48	0.0384	212	37.24	2625	1230
BOBOLINK/AW	725	50.14	45X4.53	7X3.02	0.0389	167	36.24	2336	1205
MARTIN/AW	685	86.67	54x4.02	19x2.41	0.0406	200	36.17	2478	1185
DIPPER/AW	685	47.2	45X4.40	7X2.93	0.0412	157	35.19	2207	1164
PHEASANT/AW	645	81.71	54X3.90	19X2.34	0.0432	189	35.1	2333	1141
BITTERN/AW	645	44.66	45x4.27	7x2.85	0.0438	148	34.17	2078	1121
SKYLARK/AW	645	17.95	36X4.78	1X4.78	0.0441	114	33.46	1893	1111
GRACKLE/AW	604	76.89	54X3.77	19X2.27	0.0461	177	33.97	2188	1093
BUNTING /AW	604	41.88	45X4.14	7X2.76	0.0466	139	33.12	1948	1079
FINCH/AW	564	71.57	54X3.65	19X2.19	0.0493	168	32.85	2043	1049
BLUEJAY/AW	564	38.9	45X4.00	7X2.66	0.0499	130	31.98	1819	1033
CURLEW/AW	524	67.73	54x3.51	7x3.51	0.053	155	31.59	1896	1003
ORTOLAN /AW	524	36.31	45X3.85	7X2.57	0.0539	121	30.81	1688	984
TANAGER/AW	524	14.52	36x4.30	1x4.30	0.0545	93	30.1	1537	974
CARDINAL/AW	483	62.81	54x3.38	7x3.38	0.0571	146	30.42	1752	956
RAIL/AW	483	33.54	45x3.70	7x2.47	0.0583	114	29.61	1558	938
CATBIRD/AW	483	13.46	36X4.14	1X4.14	0.0588	87	28.98	1420	929
CANARY/AW	456	59.15	54x3.28	7x3.28	0.0607	137	29.52	1653	920
RUDDY/AW	456	31.67	45x3.59	7x2.40	0.0619	107	28.74	1470	903
MALLARY/AW	403	91.78	30X4.14	19x2.48	0.0666	165	28.96	1726	894
CONDOR/AW	403	52.15	54x3.08	7x3.08	0.0688	123	27.72	1458	850
TERN/AW	403	27.83	45X3.38	7x2.25	0.0699	95	27.03	1298	837
DRAKE/AW	403	65.44	26x4.44	7x3.45	0.068	135	28.11	1549	877
CUCKOO/AW	403	52.15	24x4.62	7x3.08	0.0688	122	27.72	1460	868
COOT/AW	403	11.16	36x3.77	1x3.77	0.0708	72	26.39	1183	825
REDWING/AW	363	82.41	30x3.92	19x2.35	0.0742	148	27.43	1552	832

The above data is approximate and subjected to manufacturing tolerance
Other types can be provided on specific request.

» Cont'd

Note:

Guideline values of current carrying capacity are valid up to 60 Hz, assuming an ambient temperature of 35 °C, final temperature of 80 °C wind velocity of 0.6 m/sec, sun radiation of 1000 W/m², emissivity of 0.5, absorption factor of 0.5.

Aluminum Conductor Aluminum Clad Steel Reinforced (ACSR/AW)



According to ASTM 549

Product Code	Cross Sectional Area		Number and Nominal Diameter of Wires		Max. DC. resistance at 20°C	Rated strength	Approx. overall diameter	Approx. Weight	Current carrying capacity
	Aluminum	Steel	Aluminum	Steel					
	mm ²		No x Ø (mm)						
STARLING/AW	363	59.15	26x4.21	7x3.28	0.0756	122	26.68	1393	819
STILT/AW	363	46.88	24x4.39	7x2.92	0.0762	110	26.32	1314	814
GANNET/AW	338	54.9	26x4.07	7x3.16	0.0809	115	25.76	1298	785
FLAMINGO/AW	338	43.72	24x4.23	7x2.82	0.082	102	25.38	1225	776
EGRET/AW	322	73.54	30x3.70	19x2.22	0.0833	133	25.9	1381	775
SOOTER/AW	322	75.26	30x3.70	7x3.70	0.0831	131	25.9	1391	776
GROSBK/AW	322	52.49	26x3.97	7x3.09	0.085	110	25.15	1238	760
ROOK/AW	322	41.88	24x4.14	7x2.76	0.0856	98	24.84	1168	755
SWIFT/AW	322	8.97	36x3.38	1x3.38	0.0882	60	23.66	946	724
KINGBIRD/AW	322	17.95	18x4.78	1x4.78	0.0873	67	23.9	1006	738
TEAL/AW	307	69.62	30x3.61	19x2.16	0.0875	127	25.24	1314	751
WOOD DUCK/AW	307	71.65	30x3.61	7x3.61	0.0873	127	25.27	1323	752
SQUAB/AW	307	49.81	26x3.87	7x3.01	0.0895	105	24.51	1177	736
PEACOCK/AW	307	39.78	24x4.03	7x2.69	0.0903	93	24.19	1112	730
EAGLE/AW	282	65.82	30x3.46	7x3.46	0.0951	119	24.22	1217	710
DOVE/AW	282	45.92	26x3.72	7x2.89	0.0968	98	23.55	1083	700
PARAKEET/AW	282	36.6	24x3.87	7x2.58	0.098	86	23.22	1022	693
OSPRAY/AW	282	15.69	18x4.47	1x4.47	0.0998	59	22.35	880	678
HEN/AW	242	56.3	30x3.20	7x3.20	0.1112	103	22.42	1043	645
HAWK/AW	242	39.49	26x3.44	7x2.68	0.1132	84	21.8	929	633
FLICKER/AW	242	31.4	24x3.58	7x2.39	0.1145	75	21.49	877	627
PELICAN/AW	242	13.46	18x4.14	1x4.14	0.1164	51	20.7	755	615
LARK/AW	201	46.88	30x2.92	7x2.92	0.1335	87	20.44	869	574
IBLS/AW	201	32.73	26x3.14	7x2.44	0.1359	70	19.88	774	564
BRANT/AW	201	26.13	24x3.27	7x2.18	0.1373	62	19.62	731	559
CHICKADEE/AW	201	11.16	18x3.77	1x3.77	0.1404	43	18.85	628	546
ORIOLE/AW	170	39.78	30x2.69	7x2.69	0.1573	75	18.83	737	517
LINNET/AW	170	27.83	26x2.89	7x2.25	0.1604	60	18.31	655	507
MERLIN/AW	170	9.46	18x3.47	1x3.47	0.1657	38	17.35	531	491
OSTRICH/AW	152	24.71	26x2.73	7x2.12	0.1801	54	17.28	583	472

The above data is approximate and subjected to manufacturing tolerance
Other types can be provided on specific request.

[» Cont'd](#)

Note:

Guideline values of current carrying capacity are valid up to 60 Hz, assuming an ambient temperature of 35 °C, final temperature of 80 °C wind velocity of 0.6 m/sec, sun radiation of 1000 W/m², emissivity of 0.5, absorption factor of 0.5.

Aluminum Conductor Aluminum Clad Steel Reinforced (ACSR/AW)



According to ASTM 549

Product Code	Cross Sectional Area		Number and Nominal Diameter of Wires		Max. DC. resistance at 20°C	Rated strength	Approx. overall diameter	Approx. Weight	Current carrying capacity
	Aluminum	Steel	Aluminum	Steel					
	mm ²		No x Ø (mm)						
PARTRIDGE/AW	135	21.99	26x2.57	7x2.00	0.2029	48	16.28	519	437
WAXWING/AW	135	7.5	18x3.09	1x3.09	0.209	30	15.45	421	424
4/0 PENGUIN/AW	107	17.87	6x4.77	1x4.77	0.2525	34	14.31	412	352
COCHIN/AW	107	62.44	12x3.37	7x3.37	0.2252	88	16.85	710	391
BRAHMA/AW	103	91.78	16x2.86	19x2.48	0.2157	120	18.12	894	407
DORKING/AW	96.7	56.3	12x3.20	7x3.20	0.2498	81	16	641	366
DOTTEREL/AW	89.6	52.15	12x3.08	7x3.08	0.2696	75	15.4	594	349
3/0 PIGEON/AW	85	14.19	6x4.25	1x4.25	0.318	28	12.75	326	304
GUINEA/AW	80.6	46.88	12x2.92	7x2.92	0.3000	68	14.6	534	326
LEGHORN/AW	68.2	39.78	12x2.69	7x2.69	0.3535	58	13.45	452	280
2/0 QUAIL/AW	67.4	11.22	6x3.78	1x3.78	0.4021	23	11.34	259	262
MINORCA/AW	56.1	32.73	12x2.44	7x2.44	0.4296	48	12.2	372	259
1/0 RAVEN /AW	53.5	8.92	6x3.37	1x3.37	0.506	19	10.11	205	227
PETREL/AW	51.6	30.1	12x2.34	7x2.34	0.4671	44	11.7	342	246
1 ROBIN/AW	42.4	7.07	6x3.00	1x3.00	0.6384	15	9	162	196
GROUSE/AW	40.5	14.12	8x2.54	1x4.24	0.634	21	9.32	205	198
2 SPARATE/AW	33.6	8.55	7x2.47	1x3.30	0.7851	16	8.24	149	191
2 SPARROW/AW	33.6	5.6	6x2.67	1x2.67	0.806	12	8.01	129	169

The above data is approximate and subjected to manufacturing tolerance
Other types can be provided on specific request.

Note:

Guideline values of current carrying capacity are valid up to 60 Hz, assuming an ambient temperature of 35 °C, final temperature of 80 °C wind velocity of 0.6 m/sec, sun radiation of 1000 W/m², emissivity of 0.5, absorption factor of 0.5.

Areal Bundled Cables (ABC):

Copper conductor insulated by XLPE



Description

This type of cables are made from Copper Conductor insulated by XLPE insulation and assembled together to form two (Duplex), three (Triplex), four (Quadruplex) or more conductors.

As per ICEA S474-76-, BS 7884 or according to customer specifications.

Application

They are used for secondary over head lines (in circuits not exceeding 600 volts phase to phase) on poles or as feeders to Residential premises.

Product Code	Phase		Max. DC. resistance at 20°C Ω/Km	Approx. overall diameter mm	Approx. Weight Kg/Km
	Cross Sectional Area	Insulation thickness			
	mm ²	mm			
Two Conductors (Duplex)					
CW1-T002-U10	10	1.1	1.829	12.6	220
CW1-T002-U11	16	1.1	1.154	14.6	334
CW1-T002-U12	25	1.1	0.7563	17	496
CW1-T002-U13	35	1.1	0.5337	19.4	695
CW1-T002-U14	50	1.5	0.3819	24	1010
CW1-T002-U15	70	1.5	0.2806	27	1320
CW1-T002-U16	95	1.5	0.198	31	1845
CW1-T002-U17	120	2	0.1578	36	2350
Three Conductors (Triplex)					
CW1-T003-U10	10	1.1	1.829	13.6	330
CW1-T003-U11	16	1.1	1.154	15.8	502
CW1-T003-U12	25	1.1	0.7563	18.4	744
CW1-T003-U13	35	1.1	0.5337	21	1040
CW1-T003-U14	50	1.5	0.3819	25.9	1515
CW1-T003-U15	70	1.5	0.2806	29.2	1980
CW1-T003-U16	95	1.5	0.198	33.5	2765
CW1-T003-U17	120	2	0.1578	38.9	3525
Four Conductors (Quadruplex)					
CW1-T004-U10	10	1.1	1.829	15.2	440
CW1-T004-U11	16	1.1	1.154	17.7	675
CW1-T004-U12	25	1.1	0.7563	20.6	995
CW1-T004-U13	35	1.1	0.5337	23.5	1390
CW1-T004-U14	50	1.5	0.3819	29	2025
CW1-T004-U15	70	1.5	0.2806	32.7	2645
CW1-T004-U16	95	1.5	0.198	37.5	3690
CW1-T004-U17	120	2	0.1578	43.6	4700

The above data is approximate and subjected to manufacturing tolerance

Areal Bundled Cables (ABC):

Aluminum conductor insulated by XLPE



Description

This type of cables are made from Aluminum Conductor insulated by XLPE insulation and assembled together to form two (Duplex), three (Triplex), four (Quadruplex) or more conductors.

As per ICEA S474-76-, BS EN 50182 or according to customer specifications.

Application

They are used for secondary over head lines (in circuits not exceeding 600 volts phase to phase) on poles or as feeders to Residential premises.

Product Code	Phase		Max. DC. resistance at 20°C	Approx. overall diameter	Approx. Weight
	Cross Sectional Area	Insulation thickness			
	mm ²	mm			
Two Conductors (Duplex)					
AW1-T002-U11	16	1.1	1.7986	14.6	135
AW1-T002-U12	25	1.1	1.1787	17	195
AW1-T002-U13	35	1.1	0.8317	19.4	265
AW1-T002-U14	50	1.5	0.5944	24	400
AW1-T002-U15	70	1.5	0.4367	27	445
AW1-T002-U16	95	1.5	0.3081	31	675
AW1-T002-U17	120	2	0.2456	36	885
Three Conductors (Triplex)					
AW1-T003-U11	16	1.1	1.7986	15.8	205
AW1-T003-U12	25	1.1	1.1787	18.4	300
AW1-T003-U13	35	1.1	0.8317	21	395
AW1-T003-U14	50	1.5	0.5944	25.9	600
AW1-T003-U15	70	1.5	0.4367	29.2	745
AW1-T003-U16	95	1.5	0.3081	33.5	1015
AW1-T003-U17	120	2	0.2456	38.9	1325
Four Conductors (Quadruplex)					
AW1-T004-U11	16	1.1	1.7986	17.7	275
AW1-T004-U12	25	1.1	1.1787	20.6	390
AW1-T004-U13	35	1.1	0.8317	23.5	535
AW1-T004-U14	50	1.5	0.5944	29	795
AW1-T004-U15	70	1.5	0.4367	32.7	995
AW1-T004-U16	95	1.5	0.3081	37.5	1350
AW1-T004-U17	120	2	0.2456	43.6	1765

The above data is approximate and subjected to manufacturing tolerance





High Temperature Low Sag (HTLS) Conductors

Overview:

"Elsewedy Cables proudly present the new section of High Temperature Low Sag (HTLS) conductors which will help our customers and utilities to optimize the efficiency of overhead lines.

Because of high cost of installation of new transmission lines, time involved and difficulty in acquiring tower sites-right of way, HTLS is the best solution for reconductoring existing lines to increase power flow and also for new lines to accommodate future contingencies and increased demand of power.

HTLS conductors consists of new developed Aluminum materials that are able to operate continuously at higher temperatures up to 150°C - 250°C, while materials used for traditional types of overhead conductors such as AAAC and ACSR are limited to maximum operating temperature of 80°C.

New materials for central core have been developed for HTLS conductors to limit the sag at high temperatures and improve mechanical properties of complete conductor (INVAR steel, Galfan steel, and polymer matrix composites)."

Product Types:

1. Aluminum Conductor Composite Core (ACCC)
2. Aluminum Conductor Steel Supported (ACSS/MA)
3. Aluminum Conductor Aluminum-Clad Steel Supported (ACSS/AW)
4. Thermal Resistant Aluminum Alloy Conductor Steel Reinforced (TACSR)
5. Thermal Resistant Aluminum Alloy Conductor Aluminum-Clad Steel Reinforced (TACSR/AW)
6. Super Thermal Resistant Aluminum Alloy Conductor Aluminum-Clad Invar Reinforced (STACIR/AW)

Table 1
Outer Layer(s) Material Types for High Temperature Low Sag Conductors

	Unit	Outer Layer(s) Type				
		1350-O	AT1	AT2	AT3	AT4
Definition		Fully Annealed Aluminum	Thermal-Resistant Aluminum Alloy (TAL)	Extra High-Strength Thermal-Resistant Aluminum Alloy (Hi-TAL)	Super Thermal-Resistant Aluminum Alloy (STAL)	Extra Thermal-Resistant Aluminum Alloy (XTAL)
Standard		ASTM B609 EN 50540	Aluminum Zirconium Alloy (Al-Zr) IEC 62004			
Density at 20°C	g/cm ³	2.703	2.703	2.703	2.703	2.703
Minimum tensile strength	MPa	60 - 95	159 - 169	225 - 248	159 - 176	159 - 169
Coefficient of linear expansion	/°C	23 × 10 ⁻⁶	23 × 10 ⁻⁶	23 × 10 ⁻⁶	23 × 10 ⁻⁶	23 × 10 ⁻⁶
Maximum resistivity at 20°C	nΩ.m	27.899	28.735	31.347	28.735	29.726
Conductivity (IACS)	%	61.8	60	55	60	58
Allowable continuous operating temperature	°C	180 - 250	150	150	210	230

Table 2
High Temperature Low Sag Conductors Types

Central Core Type		Outer Layer(s) Type				
		1350-O Fully Annealed Aluminum	AT1 Thermal-Resistant Aluminum Alloy	AT2 Extra High-Strength Thermal-Resistant Aluminum Alloy	AT3 Super Thermal-Resistant Aluminum Alloy	AT4 Extra Thermal-Resistant Aluminum Alloy
Central Core Type	Carbon-Glass Fiber Composite Core	ACCC				
	Galvanized Steel Core	ACSS	TACSR	Hi-TACSR		
	Zinc-5% Aluminum Mischmetal Alloy-Coated Steel Core (Galfan)	ACSS/MA* 2)				
	Aluminum-Clad Steel Core	ACSS/AW	TACSR/AW	Hi-TACSR/AW		
	Galvanized Invar Core		TACIR 1)	Hi-TACIR 1)	STACIR 1)	XTACIR 1)
	Aluminum-Clad Invar Core		TACIR/AW 1)	Hi-TACIR/AW 1)	STACIR/AW	XTACIR/AW

Note:
All abovementioned conductor types can be offered with round wires or trapezoidal wires (TW), except the ACCC that shall be with trapezoidal wires only.
1) These types aren't commonly used.
2) There are different gorges of Mischmetal Alloy-Coated Steel Core such as MA1, MA2, MA3, MA4, MA5.

Maximum Operating Temperature for Overhead Conductors

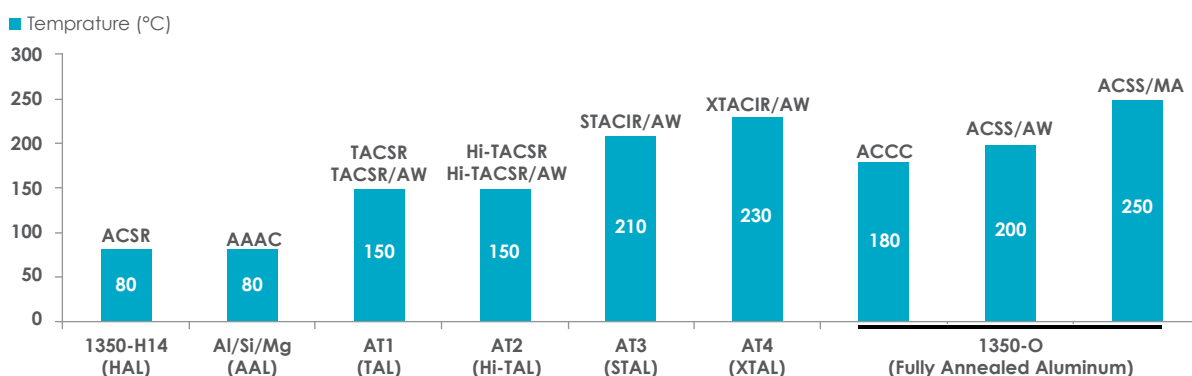

Aluminum Conductor Composite Core (ACCC)



Description

Aluminum Conductor Composite Core (ACCC) is a concentrically stranded conductor with one or more layers of trapezoidal shaped annealed 1350-O aluminum wires on a central core of light weight Carbon-Glass fiber composite.

Advantages

The ACCC Hybrid Carbon Composite Core is stronger and lighter than the traditional steel core.

ACCC is capable to carry twice the current of the traditional ACSR conductor as it's designed for continuous operating temperature up to 180°C, in addition to its lighter core which allows to use about 30% more aluminum without increasing the total weight.

Usage of ACCC reduces line losses by 30 to 40% -under equal load conditions- compared to traditional ACSR conductors of the same diameter and weight.

Greater strength, effective self-damping, superior fatigue resistance and low coefficient of thermal expansion of ACCC reduce conductor sag under heavy electrical load conditions that lead to increased spans between fewer or shorter structures.

ACCC conductors have greater corrosion resistance than traditional ACSR.

Application

ACCC conductors are used for overhead distribution and transmission lines as they're especially useful in reconductoring applications requiring increased current with existing tensions and clearances, new line applications where structures can be economized due to reduced conductor sag, new line applications requiring high emergency loadings, and lines where vibration due to wind is a problem, also they can be used at corrosive and coastal environments due to their good corrosion resistance.

Code	Aluminum Cross Section Area	Minimum Number of Layers of Aluminum	Nominal Diameter		Approx. Weight of ACCC Conductor	Rated Tensile Strength	Max. DC Resistance at 20°C	Current Rating at 180°C ¹⁾
			Core	Conductor				
	mm ²		mm		kg/km	kN	Ohm/km	Amp
Helsinki	151	2	5.97	15.65	471	68.9	0.1862	765
Copenhagen	220	2	5.97	18.29	661	72.8	0.1272	971
Reykjavik	223	2	7.11	18.82	694	98.3	0.1256	986
Monte Carlo	229	2	10.54	20.78	799	201.2	0.123	1027
Glasgow	237	2	7.75	19.53	732	115	0.1184	1027
Casablanca	274	2	7.11	20.5	834	101.1	0.1024	1120
Oslo	314	2	8.76	22.4	981	147.8	0.0893	1234
Lisbon	316	2	7.11	21.79	948	103.5	0.0887	1227
Amsterdam	367	2	7.75	23.55	1101	122.4	0.0762	1355
Brussels	421	2	8.13	25.15	1265	135.7	0.0666	1479
Stockholm 2L	463	2	8.76	26.4	1395	156.2	0.0605	1576
Warsaw	508	2	8.76	27.72	1519	158.7	0.0553	1673
Dublin	525	2	9.53	28.14	1583	183.3	0.0534	1711
Hamburg	546	3	8.76	28.62	1627	160.9	0.0514	1752
Kolkata	544	3	9.53	28.62	1643	184	0.0517	1748
Milan	568	3	8.76	29.1	1686	162.1	0.0494	1797
Rome	593	3	9.53	29.89	1774	187.1	0.0474	1850
Vienna	629	3	8.76	30.42	1852	165.5	0.0445	1918
Budapest	668	3	9.53	31.5	1984	191.4	0.042	1996
Prague	691	3	8.76	31.77	2030	169	0.0407	2032
Mumbai	685	3	9.53	31.77	2035	192	0.041	2025
Munich	733	3	9.53	32.85	2170	195	0.0384	2113
London	759	3	9.78	33.4	2248	204.8	0.037	2164
Paris	814	3	8.76	34.16	2366	175.9	0.0345	2254
Antwerp	945	3	9.78	36.85	2760	215.2	0.0297	2483
Berlin (Madrid Ice)	1007	3	10.54	38.2	2949	245	0.0278	2594

General Notes (for all products):

* Guideline values of current carrying capacity are valid up to 60 Hz, assuming an ambient temperature of 40°C, wind velocity of 0.6 m/sec, sun radiation of 1033 W/m², emissivity of 0.5, absorption factor of 0.5

* Other sizes according to different standards or client specifications are available upon request

Aluminum Conductor Steel Supported (ACSS/MA)



Description

Aluminum Conductor Steel Supported (ACSS) consists of one or more layers of annealed aluminum 1350-O wires stranded over a central core of zinc-5% aluminum mischmetal alloy-coated steel wires that is designed to withstand most or all of the mechanical load on ACSS.

ACSS conductors are manufactured according to ASTM B 856, other standards could be offered.

Advantages

ACSS conductors are similar to traditional ACSR with some very important additional advantages. ACSS can operate continuously at high temperatures up to 250°C without damage.

ACSS sags less under emergency electrical loading than ACSR, it has self-damping properties and its final sags are not affected by long time creep of the aluminum.

Application

ACSS conductors are used for overhead distribution and transmission lines as they're especially useful in reconductoring applications requiring increased current with existing tensions and clearances, new line applications where structures can be economized due to reduced conductor sag, new line applications requiring high emergency loadings, and lines where vibration due to wind is a problem.

Code	Size	Construction No. x Wire Diameter		Cross Section Area		Nominal Outer Diameter	Approx. Weight			Rated Tensile Strength		Max. DC Resistance at 20°C	Current Rating at 200°C ⁽¹⁾	Current Rating at 250°C ⁽¹⁾
		Al	Steel	Total	Al		Total	Al	Steel	MA3 ⁽²⁾	MA5 ⁽²⁾			
		No. x mm		mm ²			kg/km			kN				
PARTRIDGE	267	26X2.57	7X2.00	157	135	16.3	545	374	172	43.3	50.7	0.2072	780	876
JUNCO	267	30X2.40	7X2.40	167	136	16.8	624	377	247	57.8	68.0	0.2044	793	891
OSTRICH	300	26X2.73	7X2.12	177	152	17.3	615	422	193	48.5	56.9	0.1836	843	947
LINNET	336	26X2.89	7X2.25	198	171	18.3	690	473	217	54.3	64.1	0.1638	907	1020
ORIOLE	336	30X2.69	7X2.69	210	170	18.8	784	474	311	72.5	85.4	0.1627	918	1032
BRANT	398	24X3.27	7X2.18	228	202	19.6	763	558	204	53.8	62.7	0.1393	1004	1129
IBIS	398	26X3.14	7X2.44	234	201	19.9	813	558	256	63.2	73.8	0.1388	1010	1137
LARK	398	30X2.92	7X2.92	248	201	20.5	924	558	366	85.8	100.6	0.1381	1021	1151
FLICKER	477	24X3.58	7X2.39	273	242	21.5	915	669	245	63.2	73.6	0.1162	1128	1271
HAWK	477	26X3.44	7X2.67	281	242	21.8	976	670	306	76.1	88.4	0.1157	1136	1280
HEN	477	30X3.20	7X3.20	298	241	22.4	1110	670	440	101.0	118.6	0.1150	1149	1295
PARAKEET	556	24X3.87	7X2.58	319	282	23.2	1068	782	286	73.8	85.8	0.0995	1247	1407
DOVE	556	26X3.72	7X2.89	329	283	23.5	1142	783	359	88.5	103.5	0.0989	1256	1417
EAGLE	556	30X3.46	7X3.46	348	282	24.2	1298	783	514	117.9	138.7	0.0983	1271	1435
PEACOCK	605	24X4.03	7X2.69	346	306	24.2	1159	848	311	80.5	93.2	0.0917	1314	1485
SQUAB	605	26X3.87	7X3.01	356	306	24.5	1236	847	389	96.5	112.3	0.0914	1321	1493
TEAL	605	30X3.61	19X2.16	377	307	25.3	1398	853	545	130.3	154.3	0.0904	1342	1517
WOOD DUCK	605	30X3.61	7X3.61	379	307	25.3	1412	853	560	125.9	148.4	0.0903	1342	1518
ROOK	636	24X4.14	7X2.76	365	323	24.8	1222	895	327	84.5	98.2	0.0869	1359	1537
GROSBKAK	636	26X3.97	7X3.09	374	322	25.2	1302	892	410	99.6	116.2	0.0868	1367	1546
EGRET	636	30X3.70	19X2.22	396	323	25.9	1471	896	576	137.4	162.8	0.0861	1385	1565
SCOTER	636	30X3.70	7X3.70	398	323	25.9	1484	896	588	132.1	155.9	0.0860	1385	1566
FLAMINGO	666	24X4.23	7X2.82	381	337	25.4	1276	934	342	88.5	102.5	0.0832	1399	1580
GANNET	666	26X4.07	7X3.16	393	338	25.8	1366	937	429	104.1	121.6	0.0826	1411	1594
STILT	716	24X4.39	7X2.92	410	363	26.3	1373	1006	366	94.7	110.0	0.0773	1467	1658
STARLING	716	26X4.21	7X3.28	421	362	26.7	1465	1003	462	112.1	130.9	0.0772	1475	1668
REDWING	716	30X3.92	19X2.35	444	362	27.5	1651	1006	645	151.2	177.4	0.0767	1494	1690
CUCKOO	795	24X4.62	7X3.08	454	402	27.7	1522	1115	407	103.6	120.2	0.0698	1566	1774
DRAKE	795	26X4.44	7X3.45	468	403	28.1	1626	1115	511	124.5	144.9	0.0694	1577	1787
MALLARD	795	30X4.14	19X2.48	496	404	29.0	1840	1122	718	168.6	197.6	0.0687	1601	1815
MACAW	795	42X3.50	7X1.94	425	404	26.8	1281	1120	162	56.0	63.2	0.0703	1545	1749
TERN	795	45X3.38	7X2.25	432	404	27.0	1336	1119	217	67.6	77.4	0.0701	1550	1755

» Cont'd

Aluminum Conductor Steel Supported (ACSS/MA)

Code	Size	Construction No. x Wire Diameter		Cross Section Area		Nominal Outer Diameter	Approx. Weight			Rated Tensile Strength		Max. DC Resistance at 20°C	Current Rating at 200°C ¹⁾	Current Rating at 250°C ¹⁾
		Al	Steel	Total	Al		Total	Al	Steel	MA3 ²⁾	MA5 ²⁾			
	Kcmil		No. x mm		mm ²		kg/km			kN				
CONDOR	795	54X3.08	7X3.08	454	402	27.7	1522	1115	407	103.6	120.2	0.0698	1566	1774
RUDDY	900	45X3.59	7X2.40	487	456	28.7	1509	1262	247	75.6	86.4	0.0622	1675	1898
CANARY	900	54X3.28	7X3.28	515	456	29.5	1726	1264	462	117.4	136.3	0.0615	1699	1925
REDBIRD	954	24X5.06	7X3.38	545	483	30.4	1828	1337	491	124.5	144.6	0.0582	1763	1997
CANVASBACK	954	30X4.53	19X2.72	594	484	31.7	2207	1343	864	201.9	237.6	0.0574	1799	2039
RAIL	954	45X3.70	7X2.47	517	484	29.6	1603	1341	262	80.1	91.6	0.0585	1743	1973
TOWHEE	954	48X3.58	7X2.79	526	483	29.8	1673	1339	334	94.7	109.1	0.0584	1748	1979
CARDINAL	954	54X3.38	7X3.38	547	485	30.4	1833	1342	491	124.5	144.7	0.0579	1767	2001
SNOWBIRD	1034	42X3.99	7X2.21	552	525	30.6	1665	1455	210	72.9	82.3	0.0541	1832	2075
ORTOLAN	1034	45X3.85	7X2.57	560	524	30.8	1735	1451	284	86.7	99.2	0.0541	1829	2080
CURLEW	1034	54X3.51	7X3.51	590	523	31.6	1977	1448	529	134.8	156.1	0.0537	1849	2104
BLUEJAY	1113	45X4.00	7X2.66	604	565	32.0	1871	1567	304	93.9	106.5	0.0501	1922	2188
FINCH	1113	54X3.65	19X2.19	637	565	32.8	2133	1573	560	147.7	172.1	0.0500	1940	2209
BUNTING	1193	45X4.14	7X2.76	648	606	33.1	2005	1678	327	100.1	114.5	0.0467	2010	2280
GRACKLE	1193	54X3.77	19X2.27	680	603	34.0	2280	1678	602	157.9	184.6	0.0468	2026	2300
BITTERN	1272	45X4.27	7X2.85	689	644	34.2	2134	1785	349	106.8	122.0	0.0439	2095	2377
PHEASANT	1272	54X3.90	19X2.34	727	645	35.1	2435	1796	640	165.9	192.4	0.0438	2117	2404
DIPPER	1352	45X4.40	7X2.93	731	684	35.2	2264	1896	369	113.4	129.1	0.0414	2173	2473
MARTIN	1352	54X4.02	19X2.41	772	685	36.2	2587	1908	678	176.1	204.2	0.0412	2198	2503
BOBOLINK	1431	45X4.53	7X3.02	775	725	36.3	2401	2009	392	120.1	137.0	0.0390	2253	2572
PLOVER	1431	54X4.14	19X2.48	819	727	37.2	2742	2024	718	186.4	216.3	0.0388	2277	2601
NUTHATCH	1511	45X4.65	7X3.10	817	764	37.2	2530	2117	413	125.0	142.3	0.0371	2330	2655
PARROT	1511	54X4.25	19X2.55	863	766	38.2	2892	2133	759	196.6	228.5	0.0368	2357	2687
RATITE	1590	42X4.94	7X2.75	847	805	37.9	2555	2230	325	111.2	125.4	0.0353	2402	2731
LAPWING	1590	45X4.77	7X3.18	860	804	38.2	2662	2228	434	131.7	149.7	0.0352	2410	2741
FALCON	1590	54X4.36	19X2.62	909	806	39.2	3046	2245	802	207.3	241.1	0.0350	2438	2774

Notes:

- 1) ACSS/MA3: supported with high-strength Zinc-5% Aluminum-Mischmetal Alloy (Zn-5Al-MM) coated steel core.
ACSS/MA5: supported with ultra-high strength Zinc-5% Aluminum-Mischmetal Alloy (Zn-5Al-MM) coated steel core.
Different grades of zinc-5% aluminum mischmetal alloy-coated steel core specified in ASTM B856 (MA1,MA2,MA4) are available upon request.
- 2) ACSS conductor also with different grades of galvanized Steel core can be offered upon request.

Aluminum Conductor Aluminum-Clad Steel Supported (ACSS/AW)



Description

Aluminum Conductor Aluminum-Clad Steel Supported (ACSS/AW) consists of one or more layers of annealed aluminum 1350-O wires stranded over a central core of aluminum clad steel wires that is designed to withstand most or all of the mechanical load on ACSS/AW.

ACSS/AW conductors are manufactured according to ASTM B 856, other standards could be offered.

Advantages

ACSS/AW can operate continuously at high temperatures up to 200°C without damage. The aluminum clad steel core, which consists of a thick layer of aluminum (approx. 10% of the nominal wire radius) over steel, gives ACSS/AW conductors the advantages of standard ACSS along with light weight and good conductivity of aluminum with the high tensile strength and ruggedness of steel.

Application

ACSS/AW conductors are used for overhead distribution and transmission lines as they're especially useful in reconductoring applications requiring increased current with existing tensions and clearances, new line applications where structures can be economized due to reduced conductor sag, new line applications requiring high emergency loadings, and lines where vibration due to wind is a problem.

ACSS/AW offers strength characteristics similar to ACSS, along with slightly greater ampacity and resistance to corrosion due to aluminum-cladding of the steel core wires.

Code	Size	Construction No. x Wire Diameter		Cross Section Area		Nominal Outer Diameter	Approx. Weight			Rated Tensile Strength	Max. DC Resistance at 20°C	Current Rating at 200°C ⁽¹⁾
		Al	ACS	Total	Al		Total	Al	ACS			
		No. x mm		mm ²			kg/km			kN		
PARTRIDGE	267	26x2.57	7x2.00	157	135	16.3	519	374	146	37.0	0.2010	792
JUNCO	267	30x2.40	7x2.40	167	136	16.8	586	377	210	50.0	0.1958	810
OSTRICH	300	26x2.73	7x2.12	177	152	17.3	585	422	163	42.0	0.1782	856
LINNET	336	26x2.89	7x2.25	198	171	18.3	657	473	184	47.0	0.1590	921
ORIOLE	336	30x2.69	7x2.69	210	170	18.8	737	474	263	63.0	0.1559	938
BRANT	398	24x3.27	7x2.18	228	202	19.6	731	558	173	46.0	0.1360	1015
IBIS	398	26x3.14	7x2.44	234	201	19.9	774	558	217	55.0	0.1347	1025
LARK	398	30x2.92	7x2.92	248	201	20.5	868	558	310	74.0	0.1323	1043
FLICKER	477	24x3.58	7x2.39	273	242	21.5	877	669	208	56.0	0.1134	1142
HAWK	477	26x3.44	7x2.67	281	242	21.8	929	670	259	66.0	0.1122	1153
HEN	477	30x3.20	7x3.20	298	241	22.4	1043	670	372	89.0	0.1102	1174
PARAKEET	556	24x3.87	7x2.58	319	282	23.2	1024	782	242	65.0	0.0971	1263
DOVE	556	26x3.72	7x2.89	329	283	23.5	1087	783	304	78.0	0.0960	1274
EAGLE	556	30x3.46	7x3.46	348	282	24.2	1219	783	435	102.0	0.0942	1297
PEACOCK	605	24x4.03	7x2.69	346	306	24.2	1111	848	263	71.0	0.0895	1330
SQUAB	605	26x3.87	7x3.01	356	306	24.5	1177	847	330	85.0	0.0887	1342
TEAL	605	30x3.61	19x2.16	377	307	25.3	1314	853	462	111.0	0.0867	1370
WOOD DUCK	605	30x3.61	7x3.61	379	307	25.3	1327	853	474	109.0	0.0866	1372
ROOK	636	24x4.14	7x2.76	365	323	24.8	1172	895	277	74.0	0.0848	1376
GROSBEAK	636	26x3.97	7x3.09	374	322	25.2	1239	892	347	89.0	0.0842	1388
EGRET	636	30x3.70	19x2.22	396	323	25.9	1383	896	488	117.0	0.0825	1414
SCOTER	636	30x3.70	7x3.70	398	323	25.9	1394	896	498	112.0	0.0824	1416
FLAMINGO	666	24x4.23	7x2.82	381	337	25.4	1224	934	289	78.0	0.0813	1416
GANNET	666	26x4.07	7x3.16	393	338	25.8	1300	937	363	93.0	0.0802	1433
STILT	716	24x4.39	7x2.92	410	363	26.3	1317	1006	310	84.0	0.0755	1485
STARLING	716	26x4.21	7x3.28	421	362	26.7	1394	1003	391	98.0	0.0749	1498
REDWING	716	30x3.92	19x2.35	444	362	27.5	1552	1006	546	131.0	0.0736	1526
CUCKOO	795	24x4.62	7x3.08	454	402	27.7	1460	1115	345	93.0	0.0681	1586
DRAKE	795	26x4.44	7x3.45	468	403	28.1	1548	1115	433	109.0	0.0674	1602
MALLARD	795	30x4.14	19x2.48	496	404	29.0	1730	1122	608	146.0	0.0659	1634

>> Cont'd

Aluminum Conductor Aluminum-Clad Steel Supported (ACSS/AW)

Code	Size	Construction No. x Wire Diameter		Cross Section Area		Nominal Outer Diameter	Approx. Weight			Rated Tensile Strength	Max. DC Resistance at 20°C	Current Rating at 200°C ¹⁾
		Al	ACS	Total	Al		Total	Al	ACS	AW2 ²⁾		
	Kcmil	No. x mm		mm ²		mm	kg/km			kN	Ohm/km	Amp
MACAW	795	42x3.50	7x1.94	425	404	26.8	1256	1120	137	51.0	0.0696	1552
TERN	795	45x3.38	7x2.25	432	404	27.0	1303	1119	184	60.0	0.0692	1560
CONDOR	795	54x3.08	7x3.08	454	402	27.7	1460	1115	345	93.0	0.0681	1586
RUDDY	900	45x3.59	7x2.40	487	456	28.7	1472	1262	210	68.0	0.0613	1687
CANARY	900	54x3.28	7x3.28	515	456	29.5	1656	1264	391	103.0	0.0601	1720
REDBIRD	954	24x5.06	7x3.38	545	483	30.4	1753	1337	416	109.0	0.0568	1785
CANVASBACK	954	30x4.53	19x2.72	594	484	31.7	2075	1343	732	175.0	0.0551	1837
RAIL	954	45x3.70	7x2.47	517	484	29.6	1562	1341	222	72.0	0.0578	1755
TOWHEE	954	48x3.58	7x2.79	526	483	29.8	1622	1339	283	85.0	0.0575	1763
CARDINAL	954	54x3.38	7x3.38	547	485	30.4	1758	1342	416	109.0	0.0566	1788
SNOWBIRD	1034	42x3.99	7x2.21	552	525	30.6	1633	1455	178	66.0	0.0535	1834
ORTOLAN	1034	45x3.85	7x2.57	560	524	30.8	1692	1451	240	78.0	0.0533	1841
CURLEW	1034	54x3.51	7x3.51	590	523	31.6	1896	1448	448	116.0	0.0524	1872
BLUEJAY	1113	45x4.00	7x2.66	604	565	32.0	1824	1567	257	84.0	0.0494	1935
FINCH	1113	54x3.65	19x2.19	637	565	32.8	2048	1573	474	128.0	0.0488	1964
BUNTING	1193	45x4.14	7x2.76	648	606	33.1	1955	1678	277	90.0	0.0461	2024
GRACKLE	1193	54x3.77	19x2.27	680	603	34.0	2188	1678	510	137.0	0.0457	2051
BITTERN	1272	45x4.27	7x2.85	689	644	34.2	2081	1785	295	96.0	0.0434	2109
PHEASANT	1272	54x3.90	19x2.34	727	645	35.1	2338	1796	542	146.0	0.0427	2137
DIPPER	1352	45x4.40	7x2.93	731	684	35.2	2208	1896	312	102.0	0.0408	2187
MARTIN	1352	54x4.02	19x2.41	772	685	36.2	2483	1908	575	155.0	0.0402	2224
BOBOLINK	1431	45x4.53	7x3.02	775	725	36.3	2341	2009	332	108.0	0.0385	2268
PLOVER	1431	54x4.14	19x2.48	819	727	37.2	2632	2024	608	164.0	0.0379	2305
NUTHATCH	1511	45x4.65	7x3.10	817	764	37.2	2467	2117	350	114.0	0.0366	2346
PARROT	1511	54x4.25	19x2.55	863	766	38.2	2776	2133	643	173.0	0.0360	2386
RATITE	1590	42x4.94	7x2.75	847	805	37.9	2505	2230	275	101.0	0.0349	2414
LAPWING	1590	45x4.77	7x3.18	860	804	38.2	2596	2228	368	120.0	0.0348	2427
FALCON	1590	54x4.36	19x2.62	909	806	39.2	2924	2245	679	183.0	0.0342	2468

Notes:

ACSS/AW2: supported with regular strength aluminum-clad core wire.

Different grades of Aluminum-Clad Steel core (High strength AW3) are available upon request.

Thermal Resistant Aluminum Alloy Conductor Steel Reinforced (TACSR)



Description

Thermal Resistant Aluminum Alloy Conductor Steel Reinforced (TACSR) consists of one or more layers of thermal resistant aluminium zirconium alloy (AT1) wires stranded over a central core of zinc coated steel wire(s).

TACSR conductors are manufactured according to IEC 62004 and IEC 60888 and generally according to IEC 61089, other standards could be offered.

Advantages

TACSR conductors are able to carry load current higher than traditional ACSR conductors about 150 % as they are designed for continuous operating temperature up to 150°C.

TACSR conductors have same installation technique of ACSR.

Application

TACSR conductors are used for overhead distribution and transmission lines as they're especially useful in new line applications requiring increased current.

Size	Construction No. x Wire Diameter		Cross Section Area		Nominal Outer Diameter	Approx. Weight			Rated Tensile Strength	Max. DC Resistance at 20°C	Modulus of Elasticity	Coefficient of Linear Expansion	Current Rating at 150°C (1)
	TAL	Steel	Total	TAL		Total	TAL	Steel					
mm ²	No. x mm		mm ²		mm	kg/km			kN	Ohm/km	kgf/mm ²	x10 ⁻⁶ /°C	Amp
58	6x3.5	1x3.5	67	58	10.5	233	158	75	19.9	0.5053	8400	18.9	378
80	6x4.2	1x4.2	97	83	12.6	336	228	108	28.5	0.3509	8400	18.9	476
95	6x4.5	1x4.5	111	95	13.5	386	262	124	32.7	0.3057	8400	18.9	520
120	30x2.3	7x2.3	154	125	16.1	572	345	227	54.2	0.2357	9080	18	621
160	30x2.6	7x2.6	196	159	18.2	731	440	291	69.3	0.1845	9080	18	726
200	30x2.9	7x2.9	244	198	20.3	909	548	362	85.6	0.1483	9080	18	834
240	30x3.2	7x3.2	298	241	22.4	1107	667	440	101.0	0.1218	9080	18	946
330	26x4.0	7x3.1	380	327	25.3	1316	902	413	110.1	0.0899	8360	19	1138
410	26x4.5	7x3.5	481	414	28.5	1669	1142	527	139.8	0.0710	8360	19	1323
480	45x3.7	7x2.47	517	484	29.6	1599	1337	262	116.6	0.0607	7250	20.8	1445
520	54x3.5	7x3.5	587	520	31.5	1963	1437	527	158.2	0.0566	7990	19.5	1523
610	54x3.8	7x3.8	692	612	34.2	2314	1694	621	186.5	0.0480	7990	19.5	1690
680	54x4.0	7x4.0	767	679	36.0	2565	1877	688	204.7	0.0433	7990	19.5	1801
680	45x4.4	7x2.9	730	684	35.1	2252	1891	362	161.5	0.0429	7250	20.8	1794

Notes:

Different grades of Galvanized steel core (high strength, extra high strength) are available upon request.

Thermal Resistant Aluminum Alloy Conductor Aluminum-Clad Steel Reinforced (TACSR/AW)



Description

Thermal Resistant Aluminum Alloy Conductor Aluminum-Clad Steel Reinforced (TACSR/AW) consists of one or more layers of thermal resistant aluminum zirconium alloy (AT1) wires stranded over a central core of stranded aluminum-clad steel (20SA Type A) wire(s) .

TACSR/AW conductors are manufactured according to IEC 62004 and IEC 61232 and generally according to IEC 61089, other standards could be offered.

Advantages

TACSR/AW conductors are able to carry load current higher than traditional ACSR conductors as they are designed for continuous operating temperature up to 150°C, additionally they have increased corrosion resistance and lower electrical resistance & lower mass than TACSR.

TACSR/AW conductors have same installation technique of ACSR.

Application

TACSR/AW conductors are used for overhead distribution and transmission lines as they're especially useful in new line applications requiring increased current, also they can be used at corrosive and coastal environments due to their good corrosion resistance.

Size	Construction No. x Wire Diameter		Cross Section Area		Nominal Outer Diameter	Approx. Weight			Rated Tensile Strength	Max. DC Resistance at 20°C	Modulus of Elasticity	Coefficient of Linear Expansion	Current Rating at 150°C (I)
	TAL	Steel	Total	TAL		Total	TAL	Steel					
mm ²	No. x mm		mm ²		mm	kg/km			kN	Ohm/km	kgf/mm ²	x10 ⁻⁶ /°C	Amp
120	30x2.3	7x2.3	154	125	16.1	537	345	193	56.0	0.2182	8100	19.2	646
160	30x2.6	7x2.6	196	159	18.2	686	440	246	71.5	0.1707	8100	19.2	755
200	30x2.9	7x2.9	244	198	20.3	854	548	306	88.4	0.1372	8100	19.2	867
210	30x3.2	7x3.2	298	241	22.4	1040	667	373	106.6	0.1127	8100	19.2	983
330	26x4.0	7x3.1	380	327	25.3	1252	902	350	115.4	0.0851	7620	20	1168
410	26x4.5	7x3.5	481	414	28.5	1588	1142	446	142.5	0.0672	7630	20	1357
480	45x3.7	7x2.47	517	484	29.6	1559	1337	222	118.6	0.0593	6910	21.5	1454
520	54x3.5	7x3.5	587	520	31.5	1883	1437	446	160.9	0.0542	7390	20.4	1549
610	54x3.8	7x3.8	692	612	34.2	2220	1694	526	186.5	0.0459	7330	20.4	1718
680	45x4.4	7x2.9	730	684	35.1	2197	1891	306	164.3	0.0420	6900	21.5	1807

Notes:

Different grades of Aluminum-Clad Steel core (high strength) are available upon request.

Super Thermal Resistant Aluminum Alloy Conductor Aluminum-Clad Invar Reinforced (STACIR/AW)



Description

Super Thermal Resistant Aluminum Alloy Conductor Aluminum-Clad Invar Reinforced (STACIR/AW) consists of one or more layers of super thermal resistant aluminium zirconium alloy (AT3) wires stranded over a central core of stranded aluminum-clad invar wires.

Invar: Special Fe/Ni alloy with very low coefficient of linear expansion.

STACIR/AW conductors are manufactured according to IEC 62004 and generally according to IEC 61089 and IEC 61232, other standards could be offered.

Advantages

STACIR/AW conductors are able to carry load current up to double than traditional ACSR conductors as they are designed for continuous operating temperature up to 210°C.

Beyond Knee point STACIR/AW conductor experiences a sag increase due to the expansion of Invar core alone (extremely low value $\leq 3.7 \times 10^{-6} / ^\circ\text{C}$) which control sag at high operating temperatures.

STACIR/AW conductors have same installation technique of ACSR, additionally they have increased corrosion resistance.

Application

STACIR/AW conductors are used for overhead distribution and transmission lines as they're especially useful in replacing existing conductors for line applications requiring increased current, also they can be used at corrosive and coastal environments due to their good corrosion resistance.

Size	Construction No. x Wire Diameter		Cross Section Area		Nominal Outer Diameter	Approx. Weight			Rated Tensile Strength	Max. DC Resistance at 20°C	Modulus of Elasticity	Coefficient of Linear Expansion	Current Rating at 210°C ¹⁾
	STAL	Invar	Total	STAL		Total	STAL	Invar					
mm ²	No. x mm		mm ²		mm	kg/km			kN	Ohm/km	kgf/mm ²	x10 ⁻⁶ /°C	Amp
135	30x2.38	7x2.38	165	133	16.7	591	369	222	55.9	0.2086	8040	16	804
160	30x2.60	7x2.60	196	159	18.2	706	440	265	65.4	0.1748	8040	16	902
200	30x2.90	7x2.90	244	198	20.3	878	548	330	80.7	0.1405	8040	16	1039
210	28x3.07	7x2.70	247	207	20.4	859	573	286	75.1	0.1355	7790	16.8	1058
220	30x3.05	7x3.05	270	219	21.4	971	606	365	87.3	0.1270	8040	16	1108
230	28x3.24	7x2.85	276	231	21.5	957	638	319	83.6	0.1217	7790	16.8	1134
238	40x2.75	7x4.20	335	238	23.6	1362	656	706	136.4	0.1129	8970	13.3	1212
240	30x3.20	7x3.20	298	241	22.4	1069	667	402	96.1	0.1154	8040	16	1179
255	26x3.54	7x2.75	297	256	22.4	1004	707	297	84.5	0.1105	7580	17.5	1205
255	36x3.00	7x3.99	342	254	24.0	1329	704	625	128.0	0.1069	8650	14.2	1251
290	28x3.64	7x3.20	348	291	24.2	1207	805	402	104.2	0.0964	7790	16.8	1320
300	26x3.85	7x3.00	352	303	24.4	1189	836	353	100.2	0.0934	7580	17.5	1343
330	26x4.00	7x3.10	380	327	25.3	1279	902	377	106.4	0.0865	7580	17.5	1410
340	28x3.92	7x3.45	403	338	26.0	1401	934	467	121.0	0.0831	7790	16.8	1452
345	26x4.11	7x3.20	401	345	26.0	1355	953	402	112.9	0.0819	7580	17.5	1462
410	26x4.50	7x3.50	481	414	28.5	1623	1142	481	135.1	0.0684	7580	17.5	1643
480 (Rail)	45x3.70	7x2.47	517	484	29.6	1576	1337	239	114.3	0.0597	6900	20.2	1776

Notes:

Galvanized invar core is available upon request.





Low Voltage Cables

**Operating Voltage
(up to 1.8/3 kV)**

Cable Construction

1. Conductor

Copper or Aluminium conductors, solid, stranded or flexible with round or sectoral shaped conductors.

2. Insulation

An extruded layer of PVC or XLPE is applied over the conductor. PVC insulated cables are suitable for maximum conductor operating temperature of 70°C or 85°C and 90°C for XLPE.

3. Assembly

In case of multicore cables' cores are assembled together using non hygroscopic filler (if needed) to fill space between cores, wrapped with suitable binder tape to form a round cable.

4. Bedding

In case of armoured cables an extruded layer of PVC or other material is applied as bedding.

5. Armouring

- Steel Tape: Double layers of steel tapes are applied helically with gap.
- Steel Wire: Galvanized steel wires are applied helically.

6. Sheath

An extruded layer of PVC is applied as an outer sheath, or according to the client special requirements.

Option

Lead Sheath: Upon request a layer of lead is extruded over the bedding layer.



Armouring of Single Core Cable

- Armouring by non-magnetic material either Aluminium Tape or Aluminium Wire armouring to reduce the magnetic losses.
- If it is required for single core cable to be armoured by steel wire armouring, the magnetic circuit around the single core cable should be interrupted by inserting insulated copper wires between the steel wires.

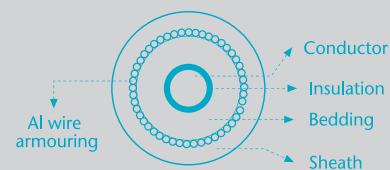
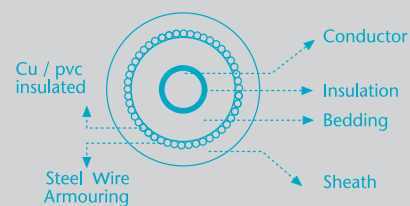

Armouring of Single Core Cable
Figure

450/750 V Indoor wires

Single Core Cables with Stranded Copper Conductors and PVC Insulated





Description

- Soft annealed stranded Copper conductors insulated with PVC compound rated 70 °C or 90 °C according to IEC 60227 & BS EN 50525-2-31.

Application

- For indoor fixed installations in dry locations, laid in conduits, as well as in steel support brackets.

Product - code	Nominal Cross Sectional Area	Max. Conductor Resistance		Current Rating in Air		Approx. Overall Diameter	Approx. Weight
		DC at 20 °C	AC at 70 °C	Free 	In Pipes 		
	mm ²	Ω/Km	Ω/Km	A	A	mm	Kg/Km
CPD-S001-U04	1.5 RE	12.1	14.6	20	15	2.8	20
CPD-T001-U04	1.5 RM	12.1	14.6	20	15	3	21
CPD-S001-U05	2 RE	9.15	10.9	22	17	3.2	27
CPD-T001-U05	2 RM	9.15	10.9	22	17	3.4	28
CPD-S001-U06	2.5 RE	7.41	8.89	28	22	3.4	31
CPD-T001-U06	2.5 RM	7.41	8.89	28	22	3.6	33
CPD-S001-U07	3 RE	6.1	7.41	31	24	3.6	36
CPD-T001-U07	3 RM	6.1	7.41	31	24	3.8	39
CPD-S001-U08	4 RE	4.61	5.51	37	26	3.9	46
CPD-T001-U08	4 RM	4.61	5.51	37	26	4.1	49
CPD-S001-U09	6 RE	3.08	3.68	46	33	4.4	66
CPD-T001-U09	6 RM	3.08	3.68	46	33	4.7	70
CPD-T001-U10	10 RM	1.83	2.17	66	47	5.8	109
CPD-T001-U11	16 RM	1.15	1.37	87	62	6.8	166
CPD-T001-U12	25	0.727	0.8600	118	81	8.8	278
CPD-T001-U13	35	0.524	0.6300	147	100	9.9	371
CPD-T001-U14	50	0.387	0.4600	197	122	11.8	514
CPD-T001-U15	70	0.268	0.3200	230	151	13.5	711
CPD-T001-U16	95	0.193	0.2300	289	191	15.7	967
CPD-T001-U17	120	0.153	0.1900	337	219	17.4	1240
CPD-T001-U18	150	0.124	0.1500	385	252	19.4	1500
CPD-T001-U19	185	0.0991	0.1200	449	288	21.5	1852
CPD-T001-U20	240	0.0754	0.0920	542	345	24.7	2457
CPD-T001-U30	300	0.0601	0.0750	621	391	27.2	2977

The above data is approximate and subjected to manufacturing tolerance.

re : round, Solid
rm : round, Stranded

Single Core Cables with Flexible Copper Conductors and PVC Insulated





Description

- Soft annealed Copper fine wires, bunched together in subunits or stranded bunched groups into a main units, which forms the flexible conductor. Insulated with soft PVC 70 °C or 90 °C Compound.
- Cables are produced according to IEC 60227 or BS EN 50525-2-31.

Application

- For indoor fixed installations in dry locations, where particular flexibility is required. For electrical panels connection or for electrical apparatus they can be laid in groups around steel sheets.

Product - code	Nominal Cross Sectional Area	Maximum Diameter of Wires	Max. Conductor Resistance		Current Rating in Air		Approx. Overall Diameter	Approx. Weight
			DC at 20 °C	AC at 70 °C	Free 	In Pipes 		
	mm ²	mm	Ω/Km	Ω/Km	A	A	mm	Kg/Km
CPD-F001-U04	1.5	0.26	13.3	15.9	20	15	3	20
CPD-F001-U06	2.5	0.26	7.98	9.56	28	22	3.7	31
CPD-F001-U08	4	0.31	4.95	5.93	37	26	4.2	44
CPD-F001-U09	6	0.31	3.3	3.95	46	33	4.7	62
CPD-F001-U10	10	0.41	1.91	2.29	66	47	6.2	108
CPD-F001-U11	16	0.41	1.21	1.45	87	62	7.2	162
CPD-F001-U12	25	0.41	0.78	0.9400	118	81	9.5	276
CPD-F001-U13	35	0.41	0.554	0.6630	147	100	11.0	375
CPD-F001-U14	50	0.41	0.386	0.4620	179	122	12.6	542
CPD-F001-U15	70	0.51	0.272	0.3260	230	151	14.6	733
CPD-F001-U16	95	0.51	0.206	0.2470	289	191	16.8	957
CPD-F001-U17	120	0.51	0.161	0.1930	337	219	18.9	1243
CPD-F001-U18	150	0.51	0.129	0.1550	385	252	21.2	1548
CPD-F001-U19	185	0.51	0.106	0.1270	449	288	23.4	1895
CPD-F001-U20	240	0.51	0.0801	0.0960	542	345	26.7	2400

The above data is approximate and subjected to manufacturing tolerance.

0.6/1 (1.2) KV Single Core Unarmoured Cables

Single Core Cables, with Stranded Circular Copper Conductors, PVC Insulated and PVC Sheathed



Description

- Soft annealed stranded Copper conductor. Insulated with PVC compound rated 70 °C and sheathed with PVC Compound layer.
- Cables are produced according to IEC 60502.

Application

- For outdoor and indoor installations in damp and wet locations. They are normally used for power distribution in urban networks, industrial plants, as well as in thermopower and hydropower stations.

1 Core - Cu/PVC/PVC

Product Code	Nominal Cross sectional area	Maximum Conductor Resistance		Current Rating						Approx. Overall Diameter	Approx. Weight
		DC at 20 °C	AC at 70 °C	Laid in ground			Laid in free air (Shaded)				
				Flat	Trefoil	Duct	Flat Separated	Flat Touched	Trefoil Touched		
mm ²	Ω/Km	Ω/Km	A	A	A	A	A	A	mm	Kg/Km	
CP1-T101-U08	4	4.61	5.51	53	53	38	50	37	35	7.1	87
CP1-T101-U09	6	3.08	3.68	65	66	47	65	48	46	7.6	113
CP1-T101-U10	10	1.83	2.17	88	89	62	89	9	62	8.3	154
CP1-T101-U11	16	1.15	1.37	113	113	77	108	85	79	9.3	216
CP1-T101-U12	25	0.727	0.8701	143	144	101	143	112	109	10.6	320
CP1-T101-U13	35	0.524	0.6273	171	173	123	176	138	134	11.7	410
CP1-T101-U14	50	0.387	0.4635	203	205	148	214	170	165	13.4	545
CP1-T101-U15	70	0.268	0.3214	248	252	183	271	215	209	15	745
CP1-T101-U16	95	0.193	0.232	296	301	224	332	267	259	17.1	1020
CP1-T101-U17	120	0.153	0.1845	337	342	255	386	310	301	18.5	1260
CP1-T101-U18	150	0.124	0.1501	378	383	292	442	357	347	20.5	1550
CP1-T101-U19	185	0.0991	0.1207	426	433	333	510	415	402	22.8	1925
CP1-T101-U20	240	0.0754	0.0931	494	501	393	608	496	481	25.8	2500
CP1-T101-U30	300	0.0601	0.0755	556	565	450	704	575	558	28.8	3110
CP1-T101-U40	400	0.047	0.0608	629	639	516	819	669	648	32	3975
CP1-T101-U50	500	0.0366	0.0495	709	721	594	957	777	753	36	5080
CP1-T101-U60	630	0.0283	0.041	792	807	672	1113	893	864	39.7	6385
CP1-T101-U70	800	0.0221	0.035	874	891	753	1284	1014	982	44.2	8260
CP1-T101-U80	1000	0.0176	0.0308	956	975	845	1478	1154	1116	51.7	10345

The above data is approximate and subjected to manufacturing tolerance.

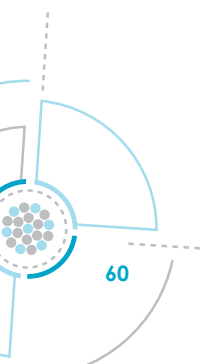

0.6/1 (1.2) KV Single Core Unarmoured Cables

Single Core Cables, with Stranded Circular Aluminium Conductors, PVC Insulated and PVC Sheathed



Description

- Soft annealed stranded Aluminum conductor. Insulated with PVC compound rated 70 °C and sheathed with PVC Compound layer.
- Cables are produced according to IEC 60502.

Application

- For outdoor and indoor installations in damp and wet locations. They are normally used for power distribution in urban networks, industrial plants, as well as in thermopower and hydropower stations.

1 Core - AL/PVC/PVC

Product Code	Nominal Cross sectional area	Maximum Conductor Resistance		Current Rating						Approx. Overall Diameter	Approx. Weight
		DC at 20 °C	AC at 70 °C	Laid in ground			Laid in free air (Shaded)				
				Flat	Trefoil	Duct	Flat Separated	Flat Touched	Trefoil Touched		
mm ²	Ω/Km	Ω/Km	A	A	A	A	A	A	mm	Kg/Km	
AP1-T101-U11	16	1.91	2.2949	86	87	60	83	65	63	9.1	120
AP1-T101-U12	25	1.2	1.4419	111	112	79	111	87	85	10.6	170
AP1-T101-U13	35	0.868	1.0431	133	134	95	136	107	104	11.7	210
AP1-T101-U14	50	0.641	0.7704	157	159	115	166	132	128	13.4	265
AP1-T101-U15	70	0.443	0.5327	193	195	142	210	167	162	15	340
AP1-T101-U16	95	0.32	0.3851	230	233	174	258	207	201	17.1	445
AP1-T101-U17	120	0.253	0.3048	262	266	198	300	241	234	18.5	535
AP1-T101-U18	150	0.206	0.2485	294	298	227	343	278	269	20.5	655
AP1-T101-U19	185	0.164	0.1984	333	338	260	397	324	314	22.8	810
AP1-T101-U20	240	0.125	0.1519	386	392	307	473	388	376	25.7	1035
AP1-T101-U30	300	0.1	0.1224	437	444	353	548	451	438	28.7	1285
AP1-T101-U40	400	0.0778	0.0964	499	508	410	644	531	515	32	1615
AP1-T101-U50	500	0.0605	0.0764	570	580	478	757	625	605	35.9	2015
AP1-T101-U60	630	0.0469	0.0612	648	660	550	889	730	707	39.6	2515
AP1-T101-U70	800	0.0367	0.0503	730	744	630	1045	850	822	44.6	3170
AP1-T101-U80	1000	0.0291	0.0425	814	830	719	1219	982	950	51.7	3950

The above data is approximate and subjected to manufacturing tolerance.

0.6/1 (1.2) KV Single Core ATA cables

Single Core Cables, With Stranded Copper Conductors, PVC insulation, Aluminum Tape Armoured, and PVC Sheathed.



Description

- Soft annealed copper conductor, insulated with PVC compound rated 70 °C, Aluminum Tape Armoured and sheathed with PVC compound layer.
- Cables are produced according to IEC 60502 .

Application

- For outdoor and indoor installation in damp and wet locations where mechanical damages are expected to occur.

1 Core - Cu/PVC/ATA/PVC

Product Code	Nominal Cross sectional area	Maximum Conductor Resistance		Current Rating						Approx. Overall Diameter	Approx. Weight
		DC at 20 °C	AC at 70 °C	Laid in ground			Laid in free air (Shaded)				
				Flat	Trefoil	Duct	Flat Separated	Flat Touched	Trefoil Touched		
				⊙⊙⊙	⊙ ⊙ ⊙	⊙ ⊙ ⊙	⊙⊙⊙	⊙⊙⊙	⊙ ⊙ ⊙		
mm ²	Ω/Km	Ω/Km	A	A	A	A	A	A	mm	Kg/Km	
CP1-T101-B12	25	0.727	0.87	144	146	108	151	124	120	14.8	465
CP1-T101-B13	35	0.524	0.6272	173	175	131	185	151	147	15.9	565
CP1-T101-B14	50	0.387	0.4634	204	207	156	223	183	179	17.6	715
CP1-T101-B15	70	0.268	0.3212	249	253	192	280	230	224	19.2	935
CP1-T101-B16	95	0.193	0.2317	297	302	232	340	281	274	21.1	1220
CP1-T101-B17	120	0.153	0.1841	337	343	265	392	325	317	22.5	1470
CP1-T101-B18	150	0.124	0.1497	377	384	300	445	371	362	24.3	1770
CP1-T101-B19	185	0.0991	0.1203	425	433	343	509	427	416	26.4	2155
CP1-T101-B20	240	0.0754	0.0926	489	500	400	599	506	494	29.4	2765
CP1-T101-B30	300	0.0601	0.075	548	562	456	684	581	569	32.2	3385
CP1-T101-B40	400	0.047	0.0601	615	633	523	779	669	656	36	4330
CP1-T101-B50	500	0.0366	0.0488	687	711	594	889	769	756	40	5475
CP1-T101-B60	630	0.0283	0.0402	761	791	671	1007	872	862	43.5	6800
CP1-T101-B70	800	0.0221	0.034	829	867	746	1121	978	970	48.4	8770
CP1-T101-B80	1000	0.0176	0.0298	889	939	826	1236	1090	1088	55.9	10935

The above data is approximate and subjected to manufacturing tolerance.

0.6/1 (1.2) KV

Single Core Cables, With Stranded Aluminium Conductors, PVC insulation, Aluminum Tape Armoured, and PVC Sheathed.



Description

- Soft annealed Aluminum conductor, insulated with PVC compound rated 70 °C, Aluminum Tape Armoured and sheathed with PVC compound layer.
- Cables are produced according to IEC 60502 .

Application

- For outdoor and indoor installation in damp and wet locations where mechanical damages are expected to occur.

1 Core - AL/PVC/ATA/PVC

Product Code	Nominal Cross sectional area mm ²	Maximum Conductor Resistance		Current Rating						Approx. Overall Diameter mm	Approx. Weight Kg/Km
		DC at 20 °C Ω/Km	AC at 70 °C Ω/Km	Laid in ground			Laid in free air (Shaded)				
				Flat	Trefoil	Duct	Flat Separated	Flat Touched	Trefoil Touched		
A	A	A	A	A	A						
AP1-T101-B11	16	1.91	2.2949	87	88	65	90	73	71	13.3	260
AP1-T101-B12	25	1.2	1.4419	112	113	84	118	96	94	14.8	315
AP1-T101-B13	35	0.868	1.043	134	136	101	144	117	114	15.9	360
AP1-T101-B14	50	0.641	0.7704	158	160	121	174	142	139	17.6	435
AP1-T101-B15	70	0.443	0.5326	194	197	150	218	179	174	19.2	525
AP1-T101-B16	95	0.32	0.385	231	235	180	265	219	213	21.1	645
AP1-T101-B17	120	0.253	0.3046	263	267	207	306	253	247	22.5	745
AP1-T101-B18	150	0.206	0.2483	294	299	233	348	289	281	24.3	880
AP1-T101-B19	185	0.164	0.1981	333	339	268	400	334	325	26.4	1040
AP1-T101-B20	240	0.125	0.1517	385	392	314	472	397	387	29.3	1295
AP1-T101-B30	300	0.1	0.1221	433	443	359	542	459	447	32.1	1555
AP1-T101-B40	400	0.0778	0.0959	493	505	417	626	535	523	36	1970
AP1-T101-B50	500	0.0605	0.0759	559	575	480	724	624	611	39.9	2415
AP1-T101-B60	630	0.0469	0.0606	630	651	549	833	721	708	43.4	2930
AP1-T101-B70	800	0.0367	0.0495	702	729	628	951	829	817	48.8	3680
AP1-T101-B80	1000	0.0291	0.0417	770	806	709	1071	942	933	55.9	4540

The above data is approximate and subjected to manufacturing tolerance.

0.6/1 (1.2) KV Single Core AWA cables

Single Core Cables, With Stranded Copper Conductors, PVC insulation, Aluminum Wire Armoured, and PVC Sheathed.



Description

- Soft annealed copper conductor, insulated with PVC compound rated 70 °C, Aluminum Wire Armoured and sheathed with PVC compound layer.
- Cables are produced according to IEC 60502 or BS 6346.

Application

- For outdoor and indoor installation in damp and wet locations where mechanical damages are expected to occur.

1 Core - Cu/PVC/AWA/PVC

Product Code	Nominal Cross sectional area	Maximum Conductor Resistance		Current Rating						Approx. Overall Diameter	Approx. Weight
		DC at 20 °C	AC at 70 °C	Laid in ground			Laid in free air (Shaded)				
				Flat	Trefoil	Duct	Flat Separated	Flat Touched	Trefoil Touched		
				⊙⊙⊙	⊙⊙⊙	⊙⊙⊙	⊙⊙⊙	⊙⊙⊙	⊙⊙⊙		
mm ²	Ω/Km	Ω/Km	A	A	A	A	A	A	mm	Kg/Km	
CP1-T101-X12	25	0.727	0.87	145	148	112	156	130	126	17.1	555
CP1-T101-X13	35	0.524	0.6272	174	177	134	190	158	154	18.2	670
CP1-T101-X14	50	0.387	0.4634	205	208	159	228	190	185	19.9	825
CP1-T101-X15	70	0.268	0.3212	250	254	196	283	237	231	21.5	1055
CP1-T101-X16	95	0.193	0.2316	296	302	236	340	287	281	23.4	1350
CP1-T101-X17	120	0.153	0.184	334	342	267	389	330	323	24.8	1620
CP1-T101-X18	150	0.124	0.1496	372	382	303	437	374	367	26.6	1930
CP1-T101-X19	185	0.0991	0.1202	415	428	342	493	427	420	28.7	2325
CP1-T101-X20	240	0.0754	0.0924	473	491	397	568	499	493	31.7	2955
CP1-T101-X30	300	0.0601	0.0747	519	544	446	630	563	561	34.8	3630
CP1-T101-X40	400	0.047	0.0598	572	605	502	699	636	639	38.4	4585
CP1-T101-X50	500	0.0366	0.0484	626	669	565	776	716	726	42.4	5740
CP1-T101-X60	630	0.0283	0.0397	677	732	623	850	794	812	46.1	7110
CP1-T101-X70	800	0.0221	0.0333	695	764	662	897	846	877	52	9290
CP1-T101-X80	1000	0.0176	0.0291	727	807	715	973	919	959	59.5	11530

The above data is approximate and subjected to manufacturing tolerance.

0.6/1 (1.2) KV

Single Core Cables, With Stranded Aluminium Conductors, PVC insulation, Aluminum Wire Armoured, and PVC Sheathed.









Description

- Soft annealed Aluminum conductor, insulated with PVC compound rated 70 °C, Aluminum Wire Armoured and sheathed with PVC compound layer.
- Cables are produced according to IEC 60502 or BS 6346.

Application

- For outdoor and indoor installation in damp and wet locations where mechanical damages are expected to occur.

1 Core - AL/PVC/AWA/PVC

Product Code	Nominal Cross sectional area	Maximum Conductor Resistance		Current Rating						Approx. Overall Diameter	Approx. Weight
		DC at 20 °C	AC at 70 °C	Laid in ground			Laid in free air (Shaded)				
				Flat	Trefoil	Duct	Flat Separated	Flat Touched	Trefoil Touched		
											
mm ²	Ω/Km	Ω/Km	A	A	A	A	A	A	mm	Kg/Km	
AP1-T101-X11	16	1.91	2.2949	88	89	67	93	77	75	15.6	330
AP1-T101-X12	25	1.2	1.4419	113	115	87	122	101	98	17.1	405
AP1-T101-X13	35	0.868	1.043	135	137	104	148	123	119	18.2	465
AP1-T101-X14	50	0.641	0.7703	159	162	124	178	148	144	19.9	545
AP1-T101-X15	70	0.443	0.5326	195	198	152	222	185	180	21.5	650
AP1-T101-X16	95	0.32	0.3849	231	236	184	268	224	219	23.4	780
AP1-T101-X17	120	0.253	0.3046	262	268	209	308	259	253	24.8	895
AP1-T101-X18	150	0.206	0.2483	292	299	237	347	294	287	26.6	1040
AP1-T101-X19	185	0.164	0.198	329	337	270	395	337	331	28.7	1210
AP1-T101-X20	240	0.125	0.1515	377	389	315	459	397	390	31.6	1485
AP1-T101-X30	300	0.1	0.1219	420	435	357	517	454	448	34.7	1800
AP1-T101-X40	400	0.0778	0.0957	470	491	408	585	522	518	38.4	2225
AP1-T101-X50	500	0.0605	0.0757	525	553	467	662	598	598	42.3	2680
AP1-T101-X60	630	0.0469	0.0603	580	617	526	740	678	683	46	3240
AP1-T101-X70	800	0.0367	0.049	616	666	578	807	748	763	52.4	4200
AP1-T101-X80	1000	0.0291	0.0411	658	719	637	889	828	851	59.5	5135

The above data is approximate and subjected to manufacturing tolerance.

0.6/1 (1.2) KV Multi Core Unarmoured Cables

Multicore Cables, with Stranded Copper Conductors PVC Insulated and PVC Sheathed



Description

- Multicore cables of stranded Copper conductors are insulated with PVC compound rated 70°C, assembled together, covered with overall jacket of PVC compound.
- Cables are produced according to IEC 60502.

Application

- For outdoor and indoor installations in damp and wet locations.

Product Code	Nominal Cross sectional area mm ²	Maximum Conductor Resistance		Current Rating			Approx. Overall Diameter mm	Approx. Overall Diameter Kg/Km
		DC at 20 °C Ω/Km	AC at 70 °C Ω/Km	Laid in ground A	Laid in duct A	Laid in free air (Shaded) A		
2 core cables - Cu/PVC/PVC								
CP1-T102-U04	1.5 RM	12.1	14.6	34	25	21	9.5	127
CP1-T102-U06	2.5 RM	7.41	8.87	43	33	29	10.4	163
CP1-T102-U08	4 RM	4.61	5.54	57	42	41	12.2	233
CP1-T102-U09	6 RM	3.08	3.69	72	53	52	13.4	300
CP1-T102-U10	10 RM	1.83	2.19	93	73	69	14.6	390
CP1-T102-U11	16 RM	1.15	1.39	122	86	92	16.6	550
CP1-T102-U12	25 RM	0.727	0.8701	156	114	121	20.1	730
CP1-T102-U13	35 RM	0.524	0.6273	189	137	149	22.3	940
CP1-T102-U14	50 SM	0.387	0.4634	236	165	186	22.5	1140
CP1-T102-U15	70 SM	0.268	0.3212	287	204	230	24.3	1565
CP1-T102-U16	95 SM	0.193	0.2317	346	249	287	28.6	2145
CP1-T102-U17	120 SM	0.153	0.1841	396	287	336	31.7	2630
CP1-T102-U18	150 SM	0.124	0.1496	443	325	383	34.5	3245
CP1-T102-U19	185 SM	0.0991	0.1201	503	373	446	39.2	4040
CP1-T102-U20	240 SM	0.0754	0.0923	582	439	528	43.8	5245
CP1-T102-U30	300 SM	0.0601	0.0745	653	497	601	47	6475
CP1-T102-U40	400 SM	0.047	0.0595	741	570	699	52.9	8310
3 core cables - Cu/PVC/PVC								
CP1-T103-U04	1.5 RM	12.1	14.6	27	21	20	10	150
CP1-T103-U06	2.5 RM	7.41	8.87	35	27	24	11	195
CP1-T103-U08	4 RM	4.61	5.54	46	36	34	12.8	282
CP1-T103-U09	6 RM	3.08	3.69	59	43	43	14.2	370
CP1-T103-U10	10 RM	1.83	2.19	78	57	59	15.5	490
CP1-T103-U11	16 RM	1.15	1.39	98	71	80	17.6	700
CP1-T103-U12	25 RM	0.727	0.8702	130	94	102	21.4	975
CP1-T103-U13	35 RM	0.524	0.6274	156	114	125	23.8	1270
CP1-T103-U14	50 SM	0.387	0.4635	189	136	151	24.2	1620
CP1-T103-U15	70 SM	0.268	0.3214	232	169	191	27.5	2280
CP1-T103-U16	95 SM	0.193	0.2319	278	205	235	31.6	3120
CP1-T103-U17	120 SM	0.153	0.1844	315	234	270	33.6	3820
CP1-T103-U18	150 SM	0.124	0.15	354	266	310	37.5	4685
CP1-T103-U19	185 SM	0.0991	0.1206	399	303	357	41.7	5870
CP1-T103-U20	240 SM	0.0754	0.0928	462	357	423	47.2	7680
CP1-T103-U30	300 SM	0.0601	0.0752	521	406	486	52.5	9600
CP1-T103-U40	400 SM	0.047	0.0603	593	468	567	59.7	12310
CP1-T103-U50	500 SM	0.0366	0.0489	668	534	650	66.4	15690

The above data is approximate and subjected to manufacturing tolerance.

rm: Round, Stranded
sm: Sector, Stranded

» Cont'd

0.6/1 (1.2) KV Multi Core Unarmoured Cables

Multicore Cables, with Stranded Copper Conductors, PVC Insulated and PVC Sheathed



Product Code	Nominal Cross sectional area mm ²	Maximum Conductor Resistance		Current Rating			Approx. Overall Diameter mm	Approx. Overall Diameter Kg/Km
		DC at 20 °C	AC at 70 °C	Laid in ground	Laid in duct	Laid in free air (Shaded)		
		Ω/Km	Ω/Km	A	A	A		
4 core cables - Cu/PVC/PVC								
CP1-T104-U04	1.5 RM	12.1	14.6	28	22	21	10.8	180
CP1-T104-U06	2.5 RM	7.41	8.87	36	28	25	11.9	235
CP1-T104-U08	4 RM	4.61	5.54	46	36	36	14	343
CP1-T104-U09	6 RM	3.08	3.69	60	44	45	15.6	454
CP1-T104-U10	10 RM	1.83	2.19	79	58	61	17	610
CP1-T104-U11	16 RM	1.15	1.39	99	73	83	19.6	880
CP1-T104-U12	25 RM	0.727	0.8702	131	96	105	23.5	1270
CP1-T104-U13	35 RM	0.524	0.6274	158	116	129	26.2	1660
CP1-T104-U14	50 SM	0.387	0.4635	195	141	161	28.3	2140
CP1-T104-U15	70 SM	0.268	0.3214	239	175	203	32.1	3025
CP1-T104-U16	95 SM	0.193	0.2319	285	211	247	35.8	4125
CP1-T104-U17	120 SM	0.153	0.1844	324	243	287	39.4	5095
CP1-T104-U18	150 SM	0.124	0.15	364	277	329	43.9	6245
CP1-T104-U19	185 SM	0.0991	0.1206	411	316	379	48.9	7840
CP1-T104-U20	240 SM	0.0754	0.0928	476	372	450	55.2	10195
CP1-T104-U30	300 SM	0.0601	0.0752	537	425	516	61.3	12720
CP1-T104-U40	400 SM	0.047	0.0603	610	490	601	69.9	16365
CP1-T104-U50	500 SM	0.0366	0.0489	689	561	690	77.4	20815
4 core cables with reduced neutral - Cu/PVC/PVC								
CP1-T105-U12	25RM / 16RM	0.727 / 1.15	0.8702 / 1.3762	130	95	103	22.6	1170
CP1-T105-U13	35RM / 16RM	0.524 / 1.15	0.6274 / 1.3762	157	115	126	24.6	1470
CP1-T105-U14	50SM / 25RM	0.387 / 0.727	0.4635 / 0.8702	195	141	161	28.3	1920
CP1-T105-U15	70SM / 35RM	0.268 / 0.524	0.3214 / 0.6274	239	175	203	31.9	2680
CP1-T105-U16	95SM / 50SM	0.193 / 0.387	0.2319 / 0.4635	282	209	243	34.3	3640
CP1-T105-U17	120SM / 70SM	0.153 / 0.268	0.1844 / 0.6214	322	241	282	37.7	4575
CP1-T105-U18	150SM / 70SM	0.124 / 0.268	0.15 / 0.6214	361	273	323	41.5	5440
CP1-T105-U19	185SM / 95SM	0.0991 / 0.193	0.1206 / 0.2319	407	311	372	46.4	6910
CP1-T105-U20	240SM / 120SM	0.0754 / 0.153	0.0928 / 0.1844	472	366	441	52.4	8905
CP1-T105-U30	300SM / 150SM	0.0601 / 0.124	0.0752 / 0.15	532	419	507	58.2	11105
CP1-T105-U40	400SM / 185SM	0.047 / 0.0991	0.0603 / 0.1206	605	482	590	65.9	14245
CP1-T105-U50	500SM / 240SM	0.0366 / 0.0754	0.0489 / 0.0928	682	550	676	73.3	18190

The above data is approximate and subjected to manufacturing tolerance.

rm: Round, Stranded
sm: Sector, Stranded

0.6/1 (1.2) KV Multi Core Unarmoured Cables

Multicore Cables, with Stranded Aluminium Conductors PVC Insulated and PVC Sheathed



Description

- Multicore cables of stranded Aluminium conductors are insulated with PVC compound rated 70°C, assembled together, covered with overall jacket of PVC compound.
- Cables are produced according to IEC 60502.

Application

- For outdoor and indoor installations in damp and wet locations.

Product Code	Nominal Cross sectional area mm ²	Maximum Conductor Resistance		Current Rating			Approx. Overall Diameter mm	Approx. Overall Diameter Kg/Km
		DC at 20 °C Ω/Km	AC at 70 °C Ω/Km	Laid in ground A	Laid in duct A	Laid in free air (Shaded) A		
2 core cables - AL/PVC/PVC								
AP1-T102-U11	16 RM	1.91	2.295	94	68	71	17.1	310
AP1-T102-U12	25 RM	1.2	1.4419	121	88	94	20.1	430
AP1-T102-U13	35 RM	0.868	1.0431	147	106	116	22.3	535
AP1-T102-U14	50 RM	0.641	0.7704	174	128	141	25.7	670
AP1-T102-U15	70 RM	0.443	0.5327	214	158	178	29.1	865
AP1-T102-U16	95 RM	0.32	0.3851	256	191	218	33.1	1115
AP1-T102-U17	120 RM	0.253	0.3048	292	221	253	36.1	1360
AP1-T102-U18	150 RM	0.206	0.2485	327	249	288	39.9	1675
AP1-T102-U19	185 RM	0.164	0.1982	370	287	333	44.5	2070
AP1-T102-U20	240 RM	0.125	0.1518	429	338	394	50.3	2650
AP1-T102-U30	300 RM	0.1	0.1221	486	386	455	56.1	3285
AP1-T102-U40	400 RM	0.0778	0.096	556	447	529	62.9	4180
3 core cables - Cu/PVC/PVC								
AP1-T103-U11	16 RM	1.91	2.295	78	56	59	18.2	380
AP1-T103-U12	25 RM	1.2	1.442	101	73	79	21.4	525
AP1-T103-U13	35 RM	0.868	1.0432	121	89	97	23.8	655
AP1-T103-U14	50 SM	0.641	0.7704	147	106	117	24.2	775
AP1-T103-U15	70 SM	0.443	0.5327	180	131	148	27.5	1035
AP1-T103-U16	95 SM	0.32	0.3851	216	159	182	31.6	1370
AP1-T103-U17	120 SM	0.253	0.3048	245	182	210	33.6	1630
AP1-T103-U18	150 SM	0.206	0.2485	275	206	241	37.5	2015
AP1-T103-U19	185 SM	0.164	0.1983	311	236	278	41.7	2470
AP1-T103-U20	240 SM	0.125	0.1518	362	279	331	47.2	3225
AP1-T103-U30	300 SM	0.1	0.1222	409	318	381	52.5	3945
AP1-T103-U40	400 SM	0.0778	0.0961	470	371	449	59.7	5170
AP1-T103-U50	500 SM	0.0605	0.076	536	428	521	66.4	6470

The above data is approximate and subjected to manufacturing tolerance.

rm: Round, Stranded
sm: Sector, Stranded

» Cont'd

0.6/1 (1.2) KV Multi Core Unarmoured Cables

Multicore Cables, with Stranded Aluminium Conductors PVC Insulated and PVC Sheathed



Product Code	Nominal Cross sectional area mm ²	Maximum Conductor Resistance		Current Rating			Approx. Overall Diameter mm	Approx. Overall Diameter Kg/Km
		DC at 20 °C	AC at 70 °C	Laid in ground	Laid in duct	Laid in free air (Shaded)		
		Ω/Km	Ω/Km	A	A	A		
4 core cables - AL/PVC/PVC								
AP1-T104-U11	16 RM	1.91	2.295	79	57	61	19.9	475
AP1-T104-U12	25 RM	1.2	1.442	102	75	81	23.5	675
AP1-T104-U13	35 RM	0.868	1.0432	123	90	100	26.2	845
AP1-T104-U14	50 SM	0.641	0.7704	151	110	125	28.3	1025
AP1-T104-U15	70 SM	0.443	0.5327	185	136	157	32.1	1360
AP1-T104-U16	95 SM	0.32	0.3851	221	164	192	35.8	1805
AP1-T104-U17	120 SM	0.253	0.3048	252	189	223	39.4	2170
AP1-T104-U18	150 SM	0.206	0.2485	283	216	256	43.9	2685
AP1-T104-U19	185 SM	0.164	0.1983	321	247	296	48.9	3290
AP1-T104-U20	240 SM	0.125	0.1518	372	291	352	55.2	4235
AP1-T104-U30	300 SM	0.1	0.1222	421	333	405	61.3	5215
AP1-T104-U40	400 SM	0.0778	0.0961	484	388	477	69.9	6845
AP1-T104-U50	500 SM	0.0605	0.076	552	450	554	77.4	8485
4 core cables with reduced neutral - AL/PVC/PVC								
AP1-T105-U12	25RM/16RM	1.2 / 1.91	1.442 / 2.295	101	74	80	22.6	630
AP1-T105-U13	35RM/16RM	0.868 / 1.91	1.0432 / 2.295	122	89	98	24.6	760
AP1-T105-U14	50SM/25RM	0.641 / 1.2	0.7704 / 1.442	151	110	125	28.3	935
AP1-T105-U15	70SM/35RM	0.443 / 0.868	0.5327 / 1.0432	186	136	158	31.9	1225
AP1-T105-U16	95SM/50SM	0.32 / 0.641	0.3851 / 0.7704	219	162	188	34.3	1620
AP1-T105-U17	120SM/70SM	0.253 / 0.443	0.3048 / 0.5327	250	187	220	37.7	1960
AP1-T105-U18	150SM/70SM	0.206 / 0.443	0.2485 / 0.5327	280	212	251	41.5	2360
AP1-T105-U19	185SM/95SM	0.164 / 0.32	0.1983 / 0.3851	318	243	290	46.4	2905
AP1-T105-U20	240SM/120SM	0.125 / 0.253	0.1518 / 0.3048	369	287	345	52.4	3720
AP1-T105-U30	300SM/150SM	0.1 / 0.206	0.1222 / 0.2485	417	328	397	58.2	4615
AP1-T105-U40	400SM/185SM	0.0778 / 0.164	0.0961 / 0.1983	479	382	467	65.9	5970
AP1-T105-U50	500SM/240SM	0.0605 / 0.125	0.076 / 0.1518	547	441	543	73.3	7485

The above data is approximate and subjected to manufacturing tolerance.

rm: Round, Stranded
sm: Sector, Stranded

0.6/1 (1.2) KV Multi Core STA cables

Multicore Cables, with Stranded Copper Conductors, PVC Insulated, Steel Tape Armoured and PVC Sheathed



Description

- Multicore cables of stranded Copper conductors are insulated with PVC compound rated 70°C, assembled together, armoured with steel tape and covered with overall jacket of PVC compound.
- Cables are produced according to IEC 60502.

Application

- For outdoor installations in damp and wet locations, where mechanical damages are expected to occur.

Product Code	Nominal Cross sectional area mm ²	Maximum Conductor Resistance		Current Rating			Approx. Overall Diameter mm	Approx. Overall Diameter Kg/Km
		DC at 20 °C	AC at 70 °C	Laid in ground	Laid in duct	Laid in free air (Shaded)		
		Ω/Km	Ω/Km	A	A	A		
2 core cables - CU/PVC/STA/PVC								
CP1-T102-A09	6 RM	3.08	3.69	71	53	53	16.4	470
CP1-T102-A10	10 RM	1.83	2.19	93	73	70	17.4	570
CP1-T102-A11	16 RM	1.15	1.39	121	86	93	19.4	750
CP1-T102-G12	25 RM	0.727	0.8701	155	114	123	22.3	930
CP1-T102-G13	35 RM	0.524	0.6273	187	138	151	24.5	1165
CP1-T102-G14	50 SM	0.387	0.4634	232	167	187	24.7	1350
CP1-T102-G15	70 SM	0.268	0.3212	283	203	231	26.5	1785
CP1-T102-G16	95 SM	0.193	0.2317	339	250	287	31.4	2455
CP1-T102-G17	120 SM	0.153	0.1841	391	290	339	35.7	3295
CP1-T102-G18	150 SM	0.124	0.1496	438	328	385	38.3	3910
CP1-T102-G19	185 SM	0.0991	0.1201	496	375	447	43.2	4845
CP1-T102-G20	240 SM	0.0754	0.0923	573	440	527	47.8	6130
CP1-T102-G30	300 SM	0.0601	0.0745	640	496	597	51.2	7450
CP1-T102-G40	400 SM	0.047	0.0595	726	570	691	57.1	9400
3 core cables - CU/PVC/STA/PVC								
CP1-T103-G08	4 RM	4.61	5.54	45	36	35	15.8	440
CP1-T103-G09	6 RM	3.08	3.69	58	43	44	17	545
CP1-T103-G10	10 RM	1.83	2.19	77	57	59	18.4	680
CP1-T103-G11	16 RM	1.15	1.39	96	72	81	20.5	910
CP1-T103-G12	25 RM	0.727	0.8702	128	95	103	23.6	1210
CP1-T103-G13	35 RM	0.524	0.6274	154	114	126	26	1535
CP1-T103-G14	50 SM	0.387	0.4635	198	140	161	26.6	1860
CP1-T103-G15	70 SM	0.268	0.3214	242	176	203	30.1	2560
CP1-T103-G16	95 SM	0.193	0.2319	293	215	255	35.6	3780
CP1-T103-G17	120 SM	0.153	0.1844	333	245	293	37.4	4500
CP1-T103-G18	150 SM	0.124	0.15	373	278	336	41.7	5490
CP1-T103-G19	185 SM	0.0991	0.1206	421	317	387	45.9	6750
CP1-T103-G20	240 SM	0.0754	0.0928	488	373	460	51.4	8660
CP1-T103-G30	300 SM	0.0601	0.0752	551	424	531	56.5	10665
CP1-T103-G40	400 SM	0.047	0.0603	627	492	621	63.9	13545
CP1-T103-G50	500 SM	0.0366	0.0489	706	560	714	70.6	17060

The above data is approximate and subjected to manufacturing tolerance.

rm: Round, Stranded
sm: Sector, Stranded

» Cont'd

0.6/1 (1.2) KV Multi Core STA cables

Multicore Cables, with Stranded Copper Conductors, PVC Insulated, Steel Tape Armoured and PVC Sheathed



Product Code	Nominal Cross sectional area mm ²	Maximum Conductor Resistance		Current Rating			Approx. Overall Diameter mm	Approx. Overall Diameter Kg/Km
		DC at 20 °C Ω/Km	AC at 70 °C Ω/Km	Laid in ground A	Laid in duct A	Laid in free air (Shaded) A		
4 core cables - CU/PVC/STA/PVC								
CP1-T104-G08	4 RM	4.61	5.54	47	37	37	17	520
CP1-T104-G09	6 RM	3.08	3.69	60	45	46	18.4	650
CP1-T104-G10	10 RM	1.83	2.19	80	59	63	19.8	820
CP1-T104-G11	16 RM	1.15	1.39	100	74	85	22.2	1120
CP1-T104-G12	25 RM	0.727	0.8702	130	96	105	25.7	1505
CP1-T104-G13	35 RM	0.524	0.6274	156	117	130	28.4	1925
CP1-T104-G14	50 SM	0.387	0.4635	204	148	172	31.1	2455
CP1-T104-G15	70 SM	0.268	0.3214	252	184	220	35.9	3680
CP1-T104-G16	95 SM	0.193	0.2319	301	222	269	39.6	4855
CP1-T104-G17	120 SM	0.153	0.1844	343	257	312	43.4	5920
CP1-T104-G18	150 SM	0.124	0.15	386	291	359	48.1	7185
CP1-T104-G19	185 SM	0.0991	0.1206	436	333	415	53.1	8875
CP1-T104-G20	240 SM	0.0754	0.0928	506	391	494	59.4	11345
CP1-T104-G30	300 SM	0.0601	0.0752	571	447	570	65.5	14000
CP1-T104-G40	400 SM	0.047	0.0603	650	517	667	74.3	17860
CP1-T104-G50	500 SM	0.0366	0.0489	736	592	774	83	23230
4 core cables with reduced neutral - CU/PVC/STA/PVC								
CP1-T105-G12	25RM / 16RM	0.727 / 1.15	0.8702 / 1.3762	129	96	104	24.8	1395
CP1-T105-G13	35RM / 16RM	0.524 / 1.15	0.6274 / 1.3762	155	116	127	26.8	1715
CP1-T105-G14	50SM / 25RM	0.387 / 0.727	0.4635 / 0.8702	193	143	162	30.5	2225
CP1-T105-G15	70SM / 35RM	0.268 / 0.524	0.3214 / 0.6274	236	176	203	34.5	3050
CP1-T105-G16	95SM / 50SM	0.193 / 0.387	0.2319 / 0.4635	298	220	264	38.1	4340
CP1-T105-G17	120SM / 70SM	0.153 / 0.268	0.1844 / 0.3214	340	253	307	41.7	5365
CP1-T105-G18	150SM / 70SM	0.124 / 0.268	0.15 / 0.3214	381	286	351	45.7	6330
CP1-T105-G19	185SM / 95SM	0.0991 / 0.193	0.1206 / 0.2319	432	329	407	50.4	7860
CP1-T105-G20	240SM / 120SM	0.0754 / 0.153	0.0928 / 0.1844	501	385	484	56.4	9975
CP1-T105-G30	300SM / 150SM	0.0601 / 0.124	0.0752 / 0.15	565	440	558	62.2	12285
CP1-T105-G40	400SM / 185SM	0.047 / 0.0991	0.0603 / 0.1206	642	509	651	70.3	15650
CP1-T105-G50	500SM / 240SM	0.0366 / 0.0754	0.0489 / 0.0928	726	582	754	78.9	20475

The above data is approximate and subjected to manufacturing tolerance.

rm: Round, Stranded
sm: Sector, Stranded

0.6/1 (1.2) KV Multi Core STA cables

Multicore Cables, with Stranded Aluminium Conductors, PVC Insulated, Steel Tape Armoured and PVC Sheathed



Description

- Multicore cables of stranded Aluminium conductors are insulated with PVC compound rated 70°C, assembled together, armoured with steel tape and covered with overall jacket of PVC compound.
- Cables are produced according to IEC 60502.

Application

- For outdoor installations in damp wet locations, where mechanical damages are expected to occur.

Product Code	Nominal Cross sectional area mm ²	Maximum Conductor Resistance		Current Rating			Approx. Overall Diameter mm	Approx. Overall Diameter Kg/Km
		DC at 20 °C Ω/Km	AC at 70 °C Ω/Km	Laid in ground A	Laid in duct A	Laid in free air (Shaded) A		
2 core cables - AL/PVC/STA/PVC								
AP1-T102-G11	16 RM	1.91	2.295	93	68	72	19.3	485
AP1-T102-G12	25 RM	1.2	1.4419	120	89	95	22.3	635
AP1-T102-G13	35 RM	0.868	1.0431	145	107	117	24.5	755
AP1-T102-G14	50 RM	0.641	0.7704	172	129	142	27.9	930
AP1-T102-G15	70 RM	0.443	0.5327	212	160	179	31.3	1155
AP1-T102-G16	95 RM	0.32	0.3851	252	192	217	35.9	1500
AP1-T102-G17	120 RM	0.253	0.3048	289	224	255	40.1	2140
AP1-T102-G18	150 RM	0.206	0.2485	324	253	290	43.7	2515
AP1-T102-G19	185 RM	0.164	0.1982	366	289	333	48.5	3030
AP1-T102-G20	240 RM	0.125	0.1518	425	339	394	54.3	3730
AP1-T102-G30	300 RM	0.1	0.1221	481	388	453	60.3	4515
AP1-T102-G40	400 RM	0.0778	0.096	549	449	526	67.1	5550
3 core cables - AL/PVC/STA/PVC								
AP1-T103-G11	16 RM	1.91	2.295	77	57	60	20.4	575
AP1-T103-G12	25 RM	1.2	1.442	99	74	80	23.6	765
AP1-T103-G13	35 RM	0.868	1.0432	120	89	98	26	925
AP1-T103-G14	50 SM	0.641	0.7704	153	109	125	26.6	1020
AP1-T103-G15	70 SM	0.443	0.5327	188	137	158	30.1	1315
AP1-T103-G16	95 SM	0.32	0.3851	227	167	198	35.6	2030
AP1-T103-G17	120 SM	0.253	0.3048	259	191	228	37.4	2310
AP1-T103-G18	150 SM	0.206	0.2485	290	217	261	41.7	2820
AP1-T103-G19	185 SM	0.164	0.1983	329	248	302	45.9	3350
AP1-T103-G20	240 SM	0.125	0.1518	383	293	361	51.4	4210
AP1-T103-G30	300 SM	0.1	0.1222	434	334	418	56.5	5010
AP1-T103-G40	400 SM	0.0778	0.0961	499	391	494	63.9	6405
AP1-T103-G50	500 SM	0.0605	0.076	569	452	575	70.6	7835

The above data is approximate and subjected to manufacturing tolerance.

rm: Round, Stranded
sm: Sector, Stranded

» Cont'd

0.6/1 (1.2) KV Multi Core STA cables

Multicore Cables, with Stranded Aluminium Conductors, PVC Insulated, Steel Tape Armoured and PVC Sheathed



Product Code	Nominal Cross sectional area mm ²	Maximum Conductor Resistance		Current Rating			Approx. Overall Diameter mm	Approx. Overall Diameter Kg/Km
		DC at 20 °C	AC at 70 °C	Laid in ground	Laid in duct	Laid in free air (Shaded)		
		Ω/Km	Ω/Km	A	A	A		
4 core cables - AL/PVC/STA/PVC								
API-T104-G11	16 RM	1.91	2.295	78	57	62	22.1	670
API-T104-G12	25 RM	1.2	1.442	101	75	82	25.7	910
API-T104-G13	35 RM	0.868	1.0432	121	91	100	28.4	1105
API-T104-G14	50 SM	0.641	0.7704	158	115	134	31.1	1340
API-T104-G15	70 SM	0.443	0.5327	196	143	171	35.9	2015
API-T104-G16	95 SM	0.32	0.3851	234	172	209	39.6	2535
API-T104-G17	120 SM	0.253	0.3048	267	200	243	43.4	2995
API-T104-G18	150 SM	0.206	0.2485	300	227	279	48.1	3620
API-T104-G19	185 SM	0.164	0.1983	341	260	324	53.1	4325
API-T104-G20	240 SM	0.125	0.1518	397	306	387	59.4	5390
API-T104-G30	300 SM	0.1	0.1222	449	351	448	65.5	6495
API-T104-G40	400 SM	0.0778	0.0961	517	411	530	74.3	8340
API-T104-G50	500 SM	0.0605	0.076	592	476	623	83	10900
4 core cables with reduced neutral - AL/PVC/STA/PVC								
API-T105-G12	25RM/16RM	1.2 / 1.91	1.442 / 2.295	100	74	81	24.8	855
API-T105-G13	35RM/16RM	0.868 / 1.91	1.0432 / 2.295	120	90	99	26.8	1005
API-T105-G14	50SM/25RM	0.641 / 1.2	0.7704 / 1.442	149	111	125	30.5	1240
API-T105-G15	70SM/35RM	0.443 / 0.868	0.5327 / 1.0432	183	137	158	34.5	1600
API-T105-G16	95SM/50SM	0.32 / 0.641	0.3851 / 0.7704	232	171	205	38.1	2315
API-T105-G17	120SM/70SM	0.253 / 0.443	0.3048 / 0.5327	265	197	239	41.7	2750
API-T105-G18	150SM/70SM	0.206 / 0.443	0.2485 / 0.5327	297	223	273	45.7	3245
API-T105-G19	185SM/95SM	0.164 / 0.32	0.1983 / 0.3851	338	257	318	50.4	3860
API-T105-G20	240SM/120SM	0.125 / 0.253	0.1518 / 0.3048	393	302	379	56.4	4790
API-T105-G30	300SM/150SM	0.1 / 0.206	0.1222 / 0.2485	445	346	439	62.2	5795
API-T105-G40	400SM/185SM	0.0778 / 0.164	0.0961 / 0.1983	511	404	517	70.3	7375
API-T105-G50	500SM/240SM	0.0605 / 0.125	0.076 / 0.1518	585	468	607	78.9	9775

The above data is approximate and subjected to manufacturing tolerance.

rm: Round, Stranded
sm: Sector, Stranded

0.6/1 (1.2) KV Multi Core SWA Cables

Multicore Cables, with Stranded Copper Conductors, PVC Insulated, Steel Wire Armoured and PVC Sheathed



Description

- Multicore cables of stranded Copper conductors are insulated with PVC compound rated 70°C, assembled together, armoured with steel wires and covered with overall jacket of PVC compound.
- Cables are produced according to IEC 60502 or BS 6346.

Application

- For outdoor installations in damp wet locations where mechanical damages are expected to occur.

Product Code	Nominal Cross sectional area mm ²	Maximum Conductor Resistance		Current Rating			Approx. Overall Diameter mm	Approx. Overall Diameter Kg/Km
		DC at 20 °C	AC at 70 °C	Laid in ground	Laid in duct	Laid in free air (Shaded)		
		Ω/Km	Ω/Km	A	A	A		
2 core cables - CU/PVC/SWA/PVC								
CP1-T102-W08	4 RM	4.61	5.54	57	44	42	15.8	480
CP1-T102-W09	6 RM	3.08	3.69	72	54	54	17.7	660
CP1-T102-W10	10 RM	1.83	2.19	93	75	72	18.9	784
CP1-T102-W11	16 RM	1.15	1.39	122	88	96	20.9	985
CP1-T102-W12	25 RM	0.727	0.8701	156	117	127	25.6	1430
CP1-T102-W13	35 RM	0.524	0.6273	188	141	155	27.8	1720
CP1-T102-W14	50 SM	0.387	0.4634	234	171	193	28.2	1920
CP1-T102-W15	70 SM	0.268	0.3212	287	211	241	30.4	2560
CP1-T102-W16	95 SM	0.193	0.2317	343	255	296	35.3	3360
CP1-T102-W17	120 SM	0.153	0.1841	392	293	345	38.2	3950
CP1-T102-W18	150 SM	0.124	0.1496	439	332	394	42	5030
CP1-T102-W19	185 SM	0.0991	0.1201	494	380	453	47.1	6115
CP1-T102-W20	240 SM	0.0754	0.0923	569	440	531	51.5	7515
CP1-T102-W30	300 SM	0.0601	0.0745	633	494	598	54.9	8910
CP1-T102-W40	400 SM	0.047	0.0595	711	562	686	60.8	11020
3 core cables - CU/PVC/SWA/PVC								
CP1-T103-W08	4 RM	4.61	5.54	45	36	36	17.2	630
CP1-T103-W09	6 RM	3.08	3.69	58	43	45	18.6	750
CP1-T103-W10	10 RM	1.83	2.19	78	57	61	19.8	905
CP1-T103-W11	16 RM	1.15	1.39	97	71	83	22	1170
CP1-T103-W12	25 RM	0.727	0.8702	129	97	106	26.9	1755
CP1-T103-W13	35 RM	0.524	0.6274	156	117	130	29.3	2135
CP1-T103-W14	50 SM	0.387	0.4635	199	145	167	30.1	2470
CP1-T103-W15	70 SM	0.268	0.3214	246	180	212	34	3420
CP1-T103-W16	95 SM	0.193	0.2319	295	218	260	38.1	4435
CP1-T103-W17	120 SM	0.153	0.1844	335	247	299	39.9	5205
CP1-T103-W18	150 SM	0.124	0.15	375	282	344	45.4	6680
CP1-T103-W19	185 SM	0.0991	0.1206	421	320	394	49.6	8085
CP1-T103-W20	240 SM	0.0754	0.0928	486	375	465	55.1	10115
CP1-T103-W30	300 SM	0.0601	0.0752	544	425	532	60.4	12315
CP1-T103-W40	400 SM	0.047	0.0603	611	482	615	68.9	16155
CP1-T103-W50	500 SM	0.0366	0.0489	677	540	696	75.8	19925

The above data is approximate and subjected to manufacturing tolerance.

rm: Round, Stranded
sm: Sector, Stranded

» Cont'd

0.6/1 (1.2) KV Multi Core SWA Cables

Multicore Cables, with Stranded Copper Conductors, PVC Insulated, Steel Wire Armoured and PVC Sheathed



Product Code	Nominal Cross sectional area mm ²	Maximum Conductor Resistance		Current Rating			Approx. Overall Diameter mm	Approx. Overall Diameter Kg/Km
		DC at 20 °C	AC at 70 °C	Laid in ground	Laid in duct	Laid in free air (Shaded)		
		Ω/Km	Ω/Km	A	A	A		
4 core cables - CU/PVC/SWA/PVC								
CP1-T104-W08	4 RM	4.61	5.54	49	36	36	18.4	725
CP1-T104-W09	6 RM	3.08	3.69	62	43	45	19.9	870
CP1-T104-W10	10 RM	1.83	2.19	84	57	60	21.3	1060
CP1-T104-W11	16 RM	1.15	1.39	105	73	82	24.4	1520
CP1-T104-W12	25 RM	0.727	0.8702	131	99	109	29	2085
CP1-T104-W13	35 RM	0.524	0.6274	157	119	133	31.9	2590
CP1-T104-W14	50 SM	0.387	0.4635	207	151	179	35	3360
CP1-T104-W15	70 SM	0.268	0.3214	254	187	225	38.6	4375
CP1-T104-W16	95 SM	0.193	0.2319	303	226	276	43.3	5990
CP1-T104-W17	120 SM	0.153	0.1844	344	260	319	47.1	7165
CP1-T104-W18	150 SM	0.124	0.15	386	294	365	51.8	8565
CP1-T104-W19	185 SM	0.0991	0.1206	434	336	420	56.8	10380
CP1-T104-W20	240 SM	0.0754	0.0928	500	389	495	63.1	13050
CP1-T104-W30	300 SM	0.0601	0.0752	560	441	567	69	15860
CP1-T104-W40	400 SM	0.047	0.0603	625	500	651	79.3	20890
CP1-T104-W50	500 SM	0.0366	0.0489	692	561	737	86.8	25770
4 core cables with reduced neutral - CU/PVC/SWA/PVC								
CP1-T105-W12	25RM / 16RM	0.727 / 1.15	0.8702 / 1.3762	130	98	107	28.1	1965
CP1-T105-W13	35RM / 16RM	0.524 / 1.15	0.6274 / 1.3762	156	118	131	30.3	2340
CP1-T105-W14	50SM / 25RM	0.387 / 0.727	0.4635 / 0.8702	195	146	167	34.4	3105
CP1-T105-W15	70SM / 35RM	0.268 / 0.524	0.3214 / 0.6274	238	180	209	38.4	4065
CP1-T105-W16	95SM / 50SM	0.193 / 0.387	0.2319 / 0.4635	300	223	269	40.6	5030
CP1-T105-W17	120SM / 70SM	0.153 / 0.268	0.1844 / 0.3214	341	256	314	45.6	6575
CP1-T105-W18	150SM / 70SM	0.124 / 0.268	0.15 / 0.3214	382	289	358	49.4	7660
CP1-T105-W19	185SM / 95SM	0.0991 / 0.193	0.1206 / 0.2319	431	331	412	54.1	9325
CP1-T105-W20	240SM / 120SM	0.0754 / 0.153	0.0928 / 0.1844	497	386	486	60.1	11590
CP1-T105-W30	300SM / 150SM	0.0601 / 0.124	0.0752 / 0.15	556	435	556	65.9	14060
CP1-T105-W40	400SM / 185SM	0.047 / 0.0991	0.0603 / 0.1206	621	494	639	75.3	18480
CP1-T105-W50	500SM / 240SM	0.0366 / 0.0754	0.0489 / 0.0928	688	553	723	82.7	22855

The above data is approximate and subjected to manufacturing tolerance.

rm: Round, Stranded
sm: Sector, Stranded

0.6/1 (1.2) KV Multi Core SWA Cables

Multicore Cables, with Stranded Aluminium Conductors, PVC Insulated, Steel Wire Armoured and PVC Sheathed



Description

- Multicore cables of stranded Aluminium conductors are insulated with PVC compound rated 70°C, assembled together, armoured with steel wires and covered with overall jacket of PVC compound.
- Cables are produced according to IEC 60502.

Application

- For outdoor installations in damp wet locations where mechanical damages are expected to occur.

Product Code	Nominal Cross sectional area mm ²	Maximum Conductor Resistance		Current Rating			Approx. Overall Diameter mm	Approx. Overall Diameter Kg/Km
		DC at 20 °C Ω/Km	AC at 70 °C Ω/Km	Laid in ground A	Laid in duct A	Laid in free air (Shaded) A		
2 core cables - AL/PVC/SWA/PVC								
AP1-T102-W11	16 RM	1.91	2.295	94	70	74	21.5	770
AP1-T102-W12	25 RM	1.2	1.4419	121	91	99	25.6	1130
AP1-T102-W13	35 RM	0.868	1.0431	146	110	120	27.8	1310
AP1-T102-W14	50 RM	0.641	0.7704	173	131	146	31.4	1575
AP1-T102-W15	70 RM	0.443	0.5327	214	163	184	35.2	2055
AP1-T102-W16	95 RM	0.32	0.3851	254	196	223	39.8	2535
AP1-T102-W17	120 RM	0.253	0.3048	290	225	258	42.6	2880
AP1-T102-W18	150 RM	0.206	0.2485	325	256	295	47.4	3790
AP1-T102-W19	185 RM	0.164	0.1982	366	291	337	52.4	4460
AP1-T102-W20	240 RM	0.125	0.1518	423	340	396	58	5295
AP1-T102-W30	300 RM	0.1	0.1221	477	387	453	64	6270
AP1-T102-W40	400 RM	0.0778	0.096	541	444	523	70.8	7495
3 core cables - AL/PVC/SWA/PVC								
AP1-T103-W11	16 RM	1.91	2.295	78	57	62	22.6	875
AP1-T103-W12	25 RM	1.2	1.442	100	76	82	26.9	1305
AP1-T103-W13	35 RM	0.868	1.0432	121	91	101	29.3	1520
AP1-T103-W14	50 SM	0.641	0.7704	155	113	130	30.1	1625
AP1-T103-W15	70 SM	0.443	0.5327	191	140	165	34	2175
AP1-T103-W16	95 SM	0.32	0.3851	229	170	202	38.1	2685
AP1-T103-W17	120 SM	0.253	0.3048	261	193	233	39.9	3015
AP1-T103-W18	150 SM	0.206	0.2485	292	220	268	45.4	4010
AP1-T103-W19	185 SM	0.164	0.1983	330	251	309	49.6	4685
AP1-T103-W20	240 SM	0.125	0.1518	383	295	366	55.1	5665
AP1-T103-W30	300 SM	0.1	0.1222	431	337	421	60.4	6660
AP1-T103-W40	400 SM	0.0778	0.0961	492	389	495	68.9	9015
AP1-T103-W50	500 SM	0.0605	0.076	555	443	570	75.8	10705

The above data is approximate and subjected to manufacturing tolerance.

rm: Round, Stranded
sm: Sector, Stranded

» Cont'd

0.6/1 (1.2) KV Multi Core SWA Cables

Multicore Cables, with Stranded Aluminium Conductors, PVC Insulated, Steel Wire Armoured and PVC Sheathed



Product Code	Nominal Cross sectional area mm ²	Maximum Conductor Resistance		Current Rating			Approx. Overall Diameter mm	Approx. Overall Diameter Kg/Km
		DC at 20 °C	AC at 70 °C	Laid in ground	Laid in duct	Laid in free air (Shaded)		
		Ω/Km	Ω/Km	A	A	A		
4 core cables - AL/PVC/SWA/PVC								
AP1-T104-W11	16 RM	1.91	2.295	79	59	64	25.4	1175
AP1-T104-W12	25 RM	1.2	1.442	102	77	84	29	1490
AP1-T104-W13	35 RM	0.868	1.0432	122	93	103	31.9	1770
AP1-T104-W14	50 SM	0.641	0.7704	160	118	139	35	2245
AP1-T104-W15	70 SM	0.443	0.5327	197	146	175	38.6	2710
AP1-T104-W16	95 SM	0.32	0.3851	236	176	215	43.3	3670
AP1-T104-W17	120 SM	0.253	0.3048	269	203	249	47.1	4240
AP1-T104-W18	150 SM	0.206	0.2485	301	230	285	51.8	5000
AP1-T104-W19	185 SM	0.164	0.1983	341	264	329	56.8	5830
AP1-T104-W20	240 SM	0.125	0.1518	395	307	391	63.1	7090
AP1-T104-W30	300 SM	0.1	0.1222	445	350	450	69	8355
AP1-T104-W40	400 SM	0.0778	0.0961	505	404	526	79.3	11370
AP1-T104-W50	500 SM	0.0605	0.076	570	463	606	86.8	13440
4 core cables with reduced neutral - AL/PVC/SWA/PVC								
AP1-T105-W12	25RM/16RM	1.2 / 1.91	1.442 / 2.295	101	76	84	28.1	1425
AP1-T105-W13	35RM/16RM	0.868 / 1.91	1.0432 / 2.295	121	92	101	30.3	1630
AP1-T105-W14	50SM/25RM	0.641 / 1.2	0.7704 / 1.442	151	113	130	34.4	2120
AP1-T105-W15	70SM/35RM	0.443 / 0.868	0.5327 / 1.0432	185	140	163	38.4	2610
AP1-T105-W16	95SM/50SM	0.32 / 0.641	0.3851 / 0.7704	233	174	209	40.6	3005
AP1-T105-W17	120SM/70SM	0.253 / 0.443	0.3048 / 0.5327	266	200	245	45.6	3955
AP1-T105-W18	150SM/70SM	0.206 / 0.443	0.2485 / 0.5327	298	226	279	49.4	4580
AP1-T105-W19	185SM/95SM	0.164 / 0.32	0.1983 / 0.3851	338	260	323	54.1	5325
AP1-T105-W20	240SM/120SM	0.125 / 0.253	0.1518 / 0.3048	392	305	383	60.1	6405
AP1-T105-W30	300SM/150SM	0.1 / 0.206	0.1222 / 0.2485	441	345	441	65.9	7575
AP1-T105-W40	400SM/185SM	0.0778 / 0.164	0.0961 / 0.1983	501	399	516	75.3	10205
AP1-T105-W50	500SM/240SM	0.0605 / 0.125	0.076 / 0.1518	565	455	594	82.7	12155

The above data is approximate and subjected to manufacturing tolerance.

rm: Round, Stranded
sm: Sector, Stranded

0.6/1 (1.2) KV Single Core Unarmoured Cables

Single Core Cables, with Stranded Circular Copper Conductors, XLPE Insulated and PVC Sheathed



Description

- Soft annealed stranded Copper conductor, Insulated with XLPE compound covered with a layer of PVC compound to form the overall jacket.
- Cables are according to IEC 60502 or BS 7889.

Application

- For outdoor and indoor installations in damp and wet locations. They are normally used for power distribution in urban networks, in industrial plants, as well as in Thermopower and Hydropower stations.

1 Core - Cu/XLPE/PVC

Product Code	Nominal Cross sectional area	Maximum Conductor Resistance		Current Rating						Approx. Overall Diameter	Approx. Weight
		DC at 20 °C	AC at 90 °C	Laid in ground			Laid in free air (Shaded)				
				Flat	Trefoil	Duct	Flat Separated	Flat Touched	Trefoil Touched		
mm ²	Ω/Km	Ω/Km	A	A	A	A	A	A	mm	Kg/Km	
CX1-T101-U08	4	4.61	5.54	60	60	42	65	47	44	6.5	75
CX1-T101-U09	6	3.08	3.69	76	77	56	80	59	59	7	98
CX1-T101-U10	10	1.83	2.19	103	105	72	103	79	75	7.7	135
CX1-T101-U11	16	1.15	1.39	129	131	92	142	110	105	8.7	195
CX1-T101-U12	25	0.727	0.9272	166	168	118	179	138	134	10	285
CX1-T101-U13	35	0.524	0.6685	199	201	143	220	171	166	11.1	380
CX1-T101-U14	50	0.387	0.4939	236	239	172	269	210	204	12.6	500
CX1-T101-U15	70	0.268	0.3425	288	292	214	340	268	260	14.4	700
CX1-T101-U16	95	0.193	0.2472	344	349	259	418	331	321	16.1	950
CX1-T101-U17	120	0.153	0.1965	391	397	298	486	386	375	17.7	1190
CX1-T101-U18	150	0.124	0.1598	439	445	339	557	446	433	19.7	1465
CX1-T101-U19	185	0.0991	0.1285	496	503	390	646	519	503	21.8	1815
CX1-T101-U20	240	0.0754	0.099	574	583	457	771	622	602	24.6	2365
CX1-T101-U30	300	0.0601	0.0803	647	658	524	895	722	699	27.4	2945
CX1-T101-U40	400	0.047	0.0645	732	744	603	1044	842	815	30.6	3780
CX1-T101-U50	500	0.0366	0.0525	826	840	695	1222	981	950	34.6	4845
CX1-T101-U60	630	0.0283	0.0431	925	942	794	1420	1132	1096	38.9	6165
CX1-T101-U70	800	0.0221	0.0366	1022	1042	894	1639	1291	1249	43.8	8045
CX1-T101-U80	1000	0.0176	0.0321	1119	1142	999	1894	1473	1423	51.1	10050

The above data is approximate and subjected to manufacturing tolerance.

0.6/1 (1.2) KV

Single Core Cables, with Stranded Aluminium Copper Conductors, XPLE Insulated and PVC Sheathed



Description

- Soft annealed stranded Aluminum conductor, Insulated with XLPE compound covered with a layer of PVC compound to form the overall jacket.
- Cables are according to IEC 60502.

Application

- For outdoor and indoor installations in damp and wet locations. They are normally used for power distribution in urban networks, in industrial plants, as well as in Thermopower and Hydropower stations.

1 Core - AL/XLPE/PVC

Product Code	Nominal Cross sectional area	Maximum Conductor Resistance		Current Rating						Approx. Overall Diameter	Approx. Weight
		DC at 20 °C	AC at 90 °C	Laid in ground			Laid in free air (Shaded)				
				Flat	Trefoil	Duct	Flat Separated	Flat Touched	Trefoil Touched		
mm ²	Ω/Km	Ω/Km	A	A	A	A	A	A	mm	Kg/Km	
AX1-T101-U11	16	1.91	2.4489	100	101	70	104	80	77	8.5	100
AX1-T101-U12	25	1.2	1.5387	129	130	92	139	107	104	10	140
AX1-T101-U13	35	0.868	1.1131	154	156	111	171	133	129	11.1	175
AX1-T101-U14	50	0.641	0.8221	183	185	134	208	163	158	12.6	220
AX1-T101-U15	70	0.443	0.5684	224	227	166	264	208	202	14.4	295
AX1-T101-U16	95	0.32	0.4109	267	271	201	324	256	249	16.1	380
AX1-T101-U17	120	0.253	0.3252	304	309	232	377	300	291	17.7	465
AX1-T101-U18	150	0.206	0.2651	341	346	263	432	346	336	19.7	575
AX1-T101-U19	185	0.164	0.2116	386	392	304	502	404	392	21.8	700
AX1-T101-U20	240	0.125	0.162	448	456	357	599	485	470	24.5	900
AX1-T101-U30	300	0.1	0.1305	507	516	411	696	566	548	27.3	1115
AX1-T101-U40	400	0.0778	0.1026	580	590	478	819	667	646	30.6	1420
AX1-T101-U50	500	0.0605	0.0813	663	675	558	965	787	762	34.5	1785
AX1-T101-U60	630	0.0469	0.0649	754	768	647	1131	922	892	38.8	2300
AX1-T101-U70	800	0.0367	0.053	850	867	744	1329	1077	1042	44.2	2950
AX1-T101-U80	1000	0.0291	0.0446	949	968	847	1556	1249	1207	51.1	3655

The above data is approximate and subjected to manufacturing tolerance.

0.6/1 (1.2) KV Single Core ATA cables

Single Core Cables, With Stranded Copper Conductors, XLPE insulation, Aluminium Tape Armoured, and PVC Sheathed.



Description

- Soft annealed copper conductor, insulated with XLPE compound rated 90 °C, Aluminum Tape Armoured and sheathed with PVC compound layer.
- Cables are produced according to IEC 60502.

Application

- For outdoor and indoor installation in damp and wet locations where mechanical damages are expected to occur.

1 Core - Cu/XLPE/ATA/PVC

Product Code	Nominal Cross sectional area	Maximum Conductor Resistance		Current Rating						Approx. Overall Diameter	Approx. Weight
		DC at 20 °C	AC at 90 °C	Laid in ground			Laid in free air (Shaded)				
				Flat	Trefoil	Duct	Flat Separated	Flat Touched	Trefoil Touched		
mm ²	Ω/Km	Ω/Km	A	A	A	A	A	A	mm	Kg/Km	
CX1-T101-B12	25	0.727	0.9272	168	170	126	190	154	150	14.2	430
CX1-T101-B13	35	0.524	0.6684	201	204	151	233	188	183	15.3	525
CX1-T101-B14	50	0.387	0.4938	237	241	181	281	229	222	16.8	660
CX1-T101-B15	70	0.268	0.3423	290	294	223	352	287	279	18.6	880
CX1-T101-B16	95	0.193	0.2469	346	351	269	429	351	341	20.1	1140
CX1-T101-B17	120	0.153	0.1962	392	399	309	495	406	395	21.7	1395
CX1-T101-B18	150	0.124	0.1595	439	447	352	563	465	452	23.5	1680
CX1-T101-B19	185	0.0991	0.1281	494	504	400	646	536	522	25.6	2055
CX1-T101-B20	240	0.0754	0.0985	570	583	470	762	636	620	28.2	2615
CX1-T101-B30	300	0.0601	0.0797	640	656	533	872	732	715	31	3220
CX1-T101-B40	400	0.047	0.0638	719	739	613	997	846	828	34.6	4120
CX1-T101-B50	500	0.0366	0.0516	805	831	698	1141	975	957	38.6	5230
CX1-T101-B60	630	0.0283	0.0423	892	926	792	1291	1110	1094	42.7	6575
CX1-T101-B70	800	0.0221	0.0356	975	1018	884	1439	1248	1236	48	8545
CX1-T101-B80	1000	0.0176	0.031	1049	1105	981	1592	1396	1390	55.5	10660

The above data is approximate and subjected to manufacturing tolerance.

0.6/1 (1.2) KV

Single Core Cables, With Stranded Aluminium Conductors, XLPE insulation, Aluminium Tape Armoured, and PVC Sheathed.



Description

- Soft annealed Aluminum conductor, insulated with XLPE compound rated 90 °C, Aluminum Tape Armoured and sheathed with PVC compound layer.
- Cables are produced according to IEC 60502.

Application

- For outdoor and indoor installation in damp and wet locations where mechanical damages are expected to occur.

1 Core - AL/XLPE/ATA/PVC

Product Code	Nominal Cross sectional area	Maximum Conductor Resistance		Current Rating						Approx. Overall Diameter	Approx. Weight
		DC at 20 °C	AC at 90 °C	Laid in ground			Laid in free air (Shaded)				
				Flat	Trefoil	Duct	Flat Separated	Flat Touched	Trefoil Touched		
mm ²	Ω/Km	Ω/Km	A	A	A	A	A	A	mm	Kg/Km	
AX1-T101-B11	16	1.91	2.4489	102	103	76	112	90	88	12.7	230
AX1-T101-B12	25	1.2	1.5386	130	132	98	148	120	116	14.2	280
AX1-T101-B13	35	0.868	1.113	156	158	117	180	146	142	15.3	320
AX1-T101-B14	50	0.641	0.822	184	187	140	218	177	172	16.8	380
AX1-T101-B15	70	0.443	0.5683	225	228	174	274	223	217	18.6	475
AX1-T101-B16	95	0.32	0.4108	269	273	209	333	272	265	20.1	570
AX1-T101-B17	120	0.253	0.325	305	310	240	386	316	308	21.7	670
AX1-T101-B18	150	0.206	0.2649	341	347	273	439	362	352	23.5	790
AX1-T101-B19	185	0.164	0.2113	386	394	313	506	419	408	25.6	940
AX1-T101-B20	240	0.125	0.1617	447	456	368	599	498	485	28.1	1145
AX1-T101-B30	300	0.1	0.1301	504	515	419	689	577	561	30.9	1390
AX1-T101-B40	400	0.0778	0.1022	574	588	488	798	675	658	34.6	1760
AX1-T101-B50	500	0.0605	0.0808	652	670	563	925	788	770	38.5	2165
AX1-T101-B60	630	0.0469	0.0643	735	759	648	1064	913	895	42.6	2705
AX1-T101-B70	800	0.0367	0.0523	821	852	743	1214	1052	1035	48.4	3460
AX1-T101-B80	1000	0.0291	0.0438	903	944	838	1371	1200	1186	55.5	4265

The above data is approximate and subjected to manufacturing tolerance.

0.6/1 (1.2) KV Single Core AWA Cables

Single Core Cables, With Stranded Copper Conductors, XLPE insulation, Aluminum Wire Armoured, and PVC Sheathed.



Description

- Soft annealed copper conductor, insulated with XLPE compound rated 90 °C, Aluminum Wire Armoured and sheathed with PVC compound layer.
- Cables are produced according to IEC 60502 or BS 5467.

Application

- For outdoor and indoor installation in damp and wet locations where mechanical damages are expected to occur.

1 Core - Cu/XLPE/AWA/PVC

Product Code	Nominal Cross sectional area	Maximum Conductor Resistance		Current Rating						Approx. Overall Diameter	Approx. Weight
		DC at 20 °C	AC at 90 °C	Laid in ground			Laid in free air (Shaded)				
				Flat	Trefoil	Duct	Flat Separated	Flat Touched	Trefoil Touched		
				⊙⊙⊙	⊙⊙⊙	⊙⊙⊙	⊙⊙⊙	⊙⊙⊙	⊙⊙⊙		
mm ²	Ω/Km	Ω/Km	A	A	A	A	A	A	mm	Kg/Km	
CX1-T101-X12	25	0.727	0.9271	170	172	130	198	162	158	16.5	515
CX1-T101-X13	35	0.524	0.6684	203	206	157	240	197	192	17.6	625
CX1-T101-X14	50	0.387	0.4938	239	243	187	288	238	232	19.1	770
CX1-T101-X15	70	0.268	0.3422	291	296	230	358	297	289	20.9	1000
CX1-T101-X16	95	0.193	0.2468	345	352	275	431	360	351	22.4	1275
CX1-T101-X17	120	0.153	0.196	389	399	314	493	414	405	24	1530
CX1-T101-X18	150	0.124	0.1593	434	445	354	555	471	461	25.8	1830
CX1-T101-X19	185	0.0991	0.1279	485	500	401	628	538	529	27.9	2220
CX1-T101-X20	240	0.0754	0.0983	553	573	466	726	630	622	30.7	2810
CX1-T101-X30	300	0.0601	0.0794	614	640	528	814	717	711	33.5	3435
CX1-T101-X40	400	0.047	0.0635	673	710	593	898	809	810	37.2	4375
CX1-T101-X50	500	0.0366	0.0512	738	787	668	997	913	923	41.2	5510
CX1-T101-X60	630	0.0283	0.0418	801	864	745	1097	1019	1038	45.1	6860
CX1-T101-X70	800	0.0221	0.0349	825	905	797	1152	1088	1126	51.6	9055
CX1-T101-X80	1000	0.0176	0.0304	864	958	862	1248	1184	1235	59.1	11245

The above data is approximate and subjected to manufacturing tolerance.

0.6/1 (1.2) KV

Single Core Cables, With Stranded Aluminium Conductors, XLPE insulation, Aluminum Wire Armoured, and PVC Sheathed.



Description

- Soft annealed Aluminium conductor, insulated with XLPE compound rated 90 °C, Aluminum Wire Armoured and sheathed with PVC compound layer.
- Cables are produced according to IEC 60502.

Application

- For outdoor and indoor installation in damp and wet locations where mechanical damages are expected to occur.

1 Core - AL/XLPE/AWA/PVC

Product Code	Nominal Cross sectional area	Maximum Conductor Resistance		Current Rating						Approx. Overall Diameter	Approx. Weight
		DC at 20 °C	AC at 90 °C	Laid in ground			Laid in free air (Shaded)				
				Flat	Trefoil	Duct	Flat Separated	Flat Touched	Trefoil Touched		
mm ²	Ω/Km	Ω/Km	A	A	A	A	A	A	mm	Kg/Km	
AX1-T101-X11	16	1.91	2.4489	103	104	78	118	96	93	15	295
AX1-T101-X12	25	1.2	1.5386	132	134	101	154	126	123	16.5	365
AX1-T101-X13	35	0.868	1.113	157	160	122	187	153	149	17.6	420
AX1-T101-X14	50	0.641	0.822	186	189	145	225	185	180	19.1	490
AX1-T101-X15	70	0.443	0.5683	227	230	179	280	231	225	20.9	595
AX1-T101-X16	95	0.32	0.4107	269	274	214	338	281	274	22.4	700
AX1-T101-X17	120	0.253	0.3249	305	311	246	389	325	317	24	805
AX1-T101-X18	150	0.206	0.2648	340	348	277	439	369	360	25.8	940
AX1-T101-X19	185	0.164	0.2112	383	393	315	501	425	415	27.9	1105
AX1-T101-X20	240	0.125	0.1616	440	453	368	585	500	491	30.6	1345
AX1-T101-X30	300	0.1	0.1299	492	509	419	663	573	564	33.4	1600
AX1-T101-X40	400	0.0778	0.102	551	574	480	749	661	655	37.2	2015
AX1-T101-X50	500	0.0605	0.0805	616	647	550	847	759	757	41.1	2445
AX1-T101-X60	630	0.0469	0.064	683	724	625	951	865	868	45	2990
AX1-T101-X70	800	0.0367	0.0518	725	782	689	1031	955	972	52	3980
AX1-T101-X80	1000	0.0291	0.0432	778	848	763	1136	1061	1089	59.1	4850

The above data is approximate and subjected to manufacturing tolerance.

0.6/1 (1.2) KV Multi Core Unarmoured Cables

Multicore Cables, with Stranded, Copper Conductors, XLPE Insulated and PVC Sheathed



Description

- Multicore cables of stranded Copper conductors are insulated with XLPE compound, assembled together and covered with an overall jacket of PVC compound.
- Cables are produced according to IEC 60502.

Application

- For outdoor and indoor installations in damp and wet locations. They are normally used for power distribution in urban networks, in industrial plants, as well as in Thermopower and Hydropower Stations.

Product Code	Nominal Cross sectional area mm ²	Maximum Conductor Resistance		Current Rating			Approx. Overall Diameter mm	Approx. Overall Diameter Kg/Km
		DC at 20 °C Ω/Km	AC at 90 °C Ω/Km	Laid in ground A	Laid in duct A	Laid in free air (Shaded) A		
2 core cables - Cu/XLPE/PVC								
CX1-T102-U04	1.5 RM	12.1	14.6	41	31	28	9.1	115
CX1-T102-U06	2.5 RM	7.41	8.87	50	39	38	10	148
CX1-T102-U08	4 RM	4.61	5.54	68	49	52	11	194
CX1-T102-U09	6 RM	3.08	3.69	86	64	67	12.2	255
CX1-T102-U10	10 RM	1.83	2.19	112	85	89	13.4	345
CX1-T102-U11	16 RM	1.15	1.39	144	102	118	15.4	500
CX1-T102-U12	25 RM	0.727	0.9272	188	133	154	18.9	675
CX1-T102-U13	35 RM	0.524	0.6685	227	162	189	21.1	880
CX1-T102-U14	50 SM	0.387	0.4938	276	193	230	20.9	1045
CX1-T102-U15	70 SM	0.268	0.3423	337	236	286	22.9	1460
CX1-T102-U16	95 SM	0.193	0.2469	405	288	357	26.6	2000
CX1-T102-U17	120 SM	0.153	0.1961	463	336	419	30.1	2485
CX1-T102-U18	150 SM	0.124	0.1593	519	378	478	32.9	3070
CX1-T102-U19	185 SM	0.0991	0.1279	590	438	560	37.5	3815
CX1-T102-U20	240 SM	0.0754	0.0982	682	513	663	41.6	4955
CX1-T102-U30	300 SM	0.0601	0.0792	767	582	757	45	6150
CX1-T102-U40	400 SM	0.047	0.0632	872	673	884	50.7	7895
3 core cables - Cu/XLPE/PVC								
CX1-T103-U04	1.5 RM	12.1	14.6	31	25	23	9.5	130
CX1-T103-U06	2.5 RM	7.41	8.87	42	33	34	10.6	175
CX1-T103-U08	4 RM	4.61	5.54	54	39	44	11.6	233
CX1-T103-U09	6 RM	3.08	3.69	68	49	53	12.9	310
CX1-T103-U10	10 RM	1.83	2.19	89	65	72	14.2	430
CX1-T103-U11	16 RM	1.15	1.39	116	82	95	16.4	625
CX1-T103-U12	25 RM	0.727	0.9273	153	110	126	20.1	895
CX1-T103-U13	35 RM	0.524	0.6686	184	132	156	22.5	1180
CX1-T103-U14	50 SM	0.387	0.494	220	157	186	22.6	1490
CX1-T103-U15	70 SM	0.268	0.3425	270	195	236	26.1	2135
CX1-T103-U16	95 SM	0.193	0.2471	324	236	290	29.4	2895
CX1-T103-U17	120 SM	0.153	0.1964	368	272	337	32.8	3605
CX1-T103-U18	150 SM	0.124	0.1597	410	307	383	35.9	4435
CX1-T103-U19	185 SM	0.0991	0.1284	464	351	441	39.9	5555
CX1-T103-U20	240 SM	0.0754	0.0988	537	414	524	45	7250
CX1-T103-U30	300 SM	0.0601	0.0799	605	471	602	49.9	9050
CX1-T103-U40	400 SM	0.047	0.0641	688	547	701	57.3	11675
CX1-T103-U50	500 SM	0.0366	0.0518	776	625	806	63.8	14945

The above data is approximate and subjected to manufacturing tolerance.

rm: Round, Stranded
sm: Sector, Stranded

» Cont'd

0.6/1 (1.2) KV Multi Core Unarmoured Cables

Multicore Cables, with Stranded, Copper Conductors, XLPE Insulated and PVC Sheathed



Product Code	Nominal Cross sectional area mm ²	Maximum Conductor Resistance		Current Rating			Approx. Overall Diameter mm	Approx. Overall Diameter Kg/Km
		DC at 20 °C	AC at 90 °C	Laid in ground	Laid in duct	Laid in free air (Shaded)		
		Ω/Km	Ω/Km	A	A	A		
4 core cables - Cu/XLPE/PVC								
CX1-T104-U04	1.5 RM	12.1	14.6	32	26	24	10.3	155
CX1-T104-U06	2.5 RM	7.41	8.87	43	33	35	11.4	210
CX1-T104-U08	4 RM	4.61	5.54	55	40	45	12.6	280
CX1-T104-U09	6 RM	3.08	3.69	70	50	55	14	385
CX1-T104-U10	10 RM	1.83	2.19	92	67	75	15.5	535
CX1-T104-U11	16 RM	1.15	1.39	118	84	98	17.9	790
CX1-T104-U12	25 RM	0.727	0.9273	155	112	131	22.1	1170
CX1-T104-U13	35 RM	0.524	0.6686	186	136	161	24.8	1545
CX1-T104-U14	50 SM	0.387	0.494	225	162	197	26.3	1970
CX1-T104-U15	70 SM	0.268	0.3425	276	204	249	30.4	2825
CX1-T104-U16	95 SM	0.193	0.2471	330	243	303	33.1	3825
CX1-T104-U17	120 SM	0.153	0.1964	374	282	352	37.2	4785
CX1-T104-U18	150 SM	0.124	0.1597	421	321	405	41.7	5875
CX1-T104-U19	185 SM	0.0991	0.1284	475	369	467	46.7	7395
CX1-T104-U20	240 SM	0.0754	0.0988	551	431	554	52.5	9620
CX1-T104-U30	300 SM	0.0601	0.0799	621	493	636	58.1	11995
CX1-T104-U40	400 SM	0.047	0.0641	706	571	741	66.7	15480
CX1-T104-U50	500 SM	0.0366	0.0518	797	653	851	74.2	19815
4 core cables with reduced neutral - Cu/XLPE/PVC								
CX1-T105-U12	25RM / 16RM	0.727 / 1.15	0.9273 / 1.4666	154	111	129	21.2	1075
CX1-T105-U13	35RM / 16RM	0.524 / 1.15	0.6686 / 1.4666	185	133	157	23.2	1365
CX1-T105-U14	50SM / 25RM	0.387 / 0.727	0.494 / 0.9273	226	163	198	26.1	1755
CX1-T105-U15	70SM / 35RM	0.268 / 0.524	0.3425 / 0.6686	277	204	250	30.2	2495
CX1-T105-U16	95SM / 50SM	0.193 / 0.387	0.2471 / 0.494	329	243	301	32.6	3380
CX1-T105-U17	120SM / 70SM	0.153 / 0.268	0.1964 / 0.3425	372	278	347	35.5	4290
CX1-T105-U18	150SM / 70SM	0.124 / 0.268	0.1597 / 0.3425	418	315	397	39.3	5115
CX1-T105-U19	185SM / 95SM	0.0991 / 0.193	0.1284 / 0.2471	472	363	458	44.2	6505
CX1-T105-U20	240SM / 120SM	0.0754 / 0.153	0.0988 / 0.1964	546	424	543	49.7	8415
CX1-T105-U30	300SM / 150SM	0.0601 / 0.124	0.0799 / 0.1597	615	485	624	55	10480
CX1-T105-U40	400SM / 185SM	0.047 / 0.0991	0.0641 / 0.1284	700	560	727	62.7	13460
CX1-T105-U50	500SM / 240SM	0.0366 / 0.0754	0.0518 / 0.0988	789	643	834	70.1	17300

The above data is approximate and subjected to manufacturing tolerance.

rm: Round, Stranded
sm: Sector, Stranded

0.6/1 (1.2) KV Multi Core Unarmoured Cables

Multicore Cables, with Stranded, Aluminum Conductors, XLPE Insulated and PVC Sheathed



Description

- Multicore cables of Stranded Aluminium conductors are insulated with XLPE compound, assembled together and covered with an overall jacket of PVC compound.
- Cables are produced according to IEC 60502.

Application

- For outdoor and indoor installations in damp and wet locations. They are normally used for power distribution in urban networks, in industrial plants, as well as in Thermopower and Hydropower Stations.

Product Code	Nominal Cross sectional area mm ²	Maximum Conductor Resistance		Current Rating			Approx. Overall Diameter mm	Approx. Overall Diameter Kg/Km
		DC at 20 °C	AC at 90 °C	Laid in ground	Laid in duct	Laid in free air (Shaded)		
		Ω/Km	Ω/Km	A	A	A		
2 core cables - AL/XLPE/PVC								
AX1-T102-U11	16 RM	1.91	2.4489	113	79	89	15.9	270
AX1-T102-U12	25 RM	1.2	1.5387	146	103	119	18.9	375
AX1-T102-U13	35 RM	0.868	1.1131	176	126	147	21.1	470
AX1-T102-U14	50 RM	0.641	0.8221	209	151	179	24.1	585
AX1-T102-U15	70 RM	0.443	0.5684	257	188	227	27.7	765
AX1-T102-U16	95 RM	0.32	0.4109	307	227	278	31.1	985
AX1-T102-U17	120 RM	0.253	0.3251	350	262	324	34.5	1230
AX1-T102-U18	150 RM	0.206	0.2651	392	297	370	38.3	1520
AX1-T102-U19	185 RM	0.164	0.2114	444	340	428	42.7	1865
AX1-T102-U20	240 RM	0.125	0.1618	516	402	509	48.1	2380
AX1-T102-U30	300 RM	0.1	0.1302	585	462	589	53.7	2975
AX1-T102-U40	400 RM	0.0778	0.1023	670	536	688	60.3	3785
3 core cables - AL/XLPE/PVC								
AX1-T103-U11	16 RM	1.91	2.4489	92	65	73	16.9	320
AX1-T103-U12	25 RM	1.2	1.5387	118	86	98	20.1	450
AX1-T103-U13	35 RM	0.868	1.1131	142	103	121	22.5	565
AX1-T103-U14	50 SM	0.641	0.8221	171	121	145	22.6	650
AX1-T103-U15	70 SM	0.443	0.5684	209	151	183	26.1	890
AX1-T103-U16	95 SM	0.32	0.4109	251	183	225	29.4	1150
AX1-T103-U17	120 SM	0.253	0.3252	286	211	262	32.8	1415
AX1-T103-U18	150 SM	0.206	0.2651	319	239	297	35.9	1765
AX1-T103-U19	185 SM	0.164	0.2115	361	274	344	39.9	2150
AX1-T103-U20	240 SM	0.125	0.1619	420	323	409	45	2795
AX1-T103-U30	300 SM	0.1	0.1302	474	369	471	49.9	3415
AX1-T103-U40	400 SM	0.0778	0.1023	544	433	555	57.3	4535
AX1-T103-U50	500 SM	0.0605	0.0809	621	501	645	63.8	5705

The above data is approximate and subjected to manufacturing tolerance.

rm: Round, Stranded
sm: Sector, Stranded

» Cont'd

0.6/1 (1.2) KV Multi Core Unarmoured Cables

Multicore Cables, with Stranded, Aluminum Conductors, XLPE Insulated and PVC Sheathed



Product Code	Nominal Cross sectional area mm ²	Maximum Conductor Resistance		Current Rating			Approx. Overall Diameter mm	Approx. Overall Diameter Kg/Km
		DC at 20 °C Ω/Km	AC at 90 °C Ω/Km	Laid in ground	Laid in duct	Laid in free air (Shaded)		
				A	A	A		
4 core cables - AL/XLPE/PVC								
AX1-T104-U11	16 RM	1.91	2.4489	93	66	76	18.5	395
AX1-T104-U12	25 RM	1.2	1.5387	120	87	101	22.1	575
AX1-T104-U13	35 RM	0.868	1.1131	144	105	125	24.8	730
AX1-T104-U14	50 SM	0.641	0.8221	175	126	153	26.3	850
AX1-T104-U15	70 SM	0.443	0.5684	215	158	194	30.4	1160
AX1-T104-U16	95 SM	0.32	0.4109	256	189	235	33.1	1500
AX1-T104-U17	120 SM	0.253	0.3252	291	219	274	37.2	1860
AX1-T104-U18	150 SM	0.206	0.2651	327	249	314	41.7	2315
AX1-T104-U19	185 SM	0.164	0.2115	370	287	364	46.7	2850
AX1-T104-U20	240 SM	0.125	0.1619	430	337	432	52.5	3670
AX1-T104-U30	300 SM	0.1	0.1302	486	386	498	58.1	4500
AX1-T104-U40	400 SM	0.0778	0.1023	558	452	586	66.7	5960
AX1-T104-U50	500 SM	0.0605	0.0809	638	522	681	74.2	7485
4 core cables with reduced neutral - AL/XLPE/PVC								
AX1-T105-U12	25RM/16RM	1.2 / 1.91	1.5387 / 2.4489	119	86	100	21.2	530
AX1-T105-U13	35RM/16RM	0.868 / 1.91	1.1131 / 2.4489	143	103	122	23.2	655
AX1-T105-U14	50SM/25RM	0.641 / 1.2	0.8221 / 1.5387	175	126	153	26.1	765
AX1-T105-U15	70SM/35RM	0.443 / 0.868	0.5684 / 1.1131	215	158	194	30.2	1040
AX1-T105-U16	95SM/50SM	0.32 / 0.641	0.4109 / 0.8221	255	188	233	32.6	1350
AX1-T105-U17	120SM/70SM	0.253 / 0.443	0.3252 / 0.5684	289	216	270	35.5	1675
AX1-T105-U18	150SM/70SM	0.206 / 0.443	0.2651 / 0.5684	324	245	308	39.3	2030
AX1-T105-U19	185SM/95SM	0.164 / 0.32	0.2115 / 0.4109	367	283	357	44.2	2515
AX1-T105-U20	240SM/120SM	0.125 / 0.253	0.1619 / 0.3252	427	332	424	49.7	3230
AX1-T105-U30	300SM/150SM	0.1 / 0.206	0.1302 / 0.2651	482	380	489	55	3980
AX1-T105-U40	400SM/185SM	0.0778 / 0.164	0.1023 / 0.2115	554	443	575	62.7	5185
AX1-T105-U50	500SM/240SM	0.0605 / 0.125	0.0809 / 0.1619	632	515	668	70.1	6580

The above data is approximate and subjected to manufacturing tolerance.

rm: Round, Stranded
sm: Sector, Stranded

0.6/1 (1.2) KV Multi Core STA Cables

Multicore Cables, with Stranded Copper Conductors, XLPE Insulated, Steel Tape Armoured and PVC Sheathed



Description

- Multicore cables of stranded Copper conductors are insulated with XLPE compound, assembled together, armoured with steel tape and covered with an overall jacket of PVC compound.
- Cables are produced according to IEC 60502.

Application

- For outdoor installations in damp wet locations where mechanical damages are expected to occur.

Product Code	Nominal Cross sectional area mm ²	Maximum Conductor Resistance		Current Rating			Approx. Overall Diameter mm	Approx. Overall Diameter Kg/Km
		DC at 20 °C Ω/Km	AC at 90 °C Ω/Km	Laid in ground	Laid in duct	Laid in free air (Shaded)		
				A	A	A		
2 core cables - CU/XLPE/STA/PVC								
CX1-T102-G09	6 RM	3.08	3.69	84	64	68	15	405
CX1-T102-G10	10 RM	1.83	2.19	110	85	90	16.2	510
CX1-T102-G11	16 RM	1.15	1.39	142	103	118	18.2	680
CX1-T102-G12	25 RM	0.727	0.9272	185	135	155	21.1	865
CX1-T102-G13	35 RM	0.524	0.6685	224	162	191	23.3	1090
CX1-T102-G14	50 SM	0.387	0.4938	272	193	231	22.9	1235
CX1-T102-G15	70 SM	0.268	0.3423	330	237	286	25.1	1675
CX1-T102-G16	95 SM	0.193	0.2469	397	289	355	29	2265
CX1-T102-G17	120 SM	0.153	0.1961	457	339	422	33.7	3085
CX1-T102-G18	150 SM	0.124	0.1593	512	381	480	36.5	3695
CX1-T102-G19	185 SM	0.0991	0.1279	580	440	559	41.5	4595
CX1-T102-G20	240 SM	0.0754	0.0982	670	513	658	45.6	5805
CX1-T102-G30	300 SM	0.0601	0.0792	751	580	749	49	7070
CX1-T102-G40	400 SM	0.047	0.0632	853	669	871	54.7	8925
3 core cables - CU/XLPE/STA/PVC								
CX1-T103-G09	6 RM	3.08	3.69	67	49	53	15.8	475
CX1-T103-G10	10 RM	1.83	2.19	88	66	73	17.1	605
CX1-T103-G11	16 RM	1.15	1.39	114	82	95	19.3	830
CX1-T103-G12	25 RM	0.727	0.9273	151	110	128	22.3	1120
CX1-T103-G13	35 RM	0.524	0.6686	182	134	157	24.7	1435
CX1-T103-G14	50 SM	0.387	0.494	230	164	199	24.6	1700
CX1-T103-G15	70 SM	0.268	0.3425	281	203	251	28.5	2390
CX1-T103-G16	95 SM	0.193	0.2471	337	246	309	32	3205
CX1-T103-G17	120 SM	0.153	0.1964	387	285	366	36.6	4280
CX1-T103-G18	150 SM	0.124	0.1597	432	322	415	39.9	5195
CX1-T103-G19	185 SM	0.0991	0.1284	488	371	480	43.9	6385
CX1-T103-G20	240 SM	0.0754	0.0988	566	434	570	49.2	8195
CX1-T103-G30	300 SM	0.0601	0.0799	639	496	658	53.9	10075
CX1-T103-G40	400 SM	0.047	0.0641	728	573	772	61.1	12810
CX1-T103-G50	500 SM	0.0366	0.0518	820	654	889	67.8	16245

The above data is approximate and subjected to manufacturing tolerance.

rm: Round, Stranded
sm: Sector, Stranded

» Cont'd

0.6/1 (1.2) KV Multi Core STA Cables

Multicore Cables, with Stranded Copper Conductors, XLPE Insulated, Steel Tape Armoured and PVC Sheathed



Product Code	Nominal Cross sectional area mm ²	Maximum Conductor Resistance		Current Rating			Approx. Overall Diameter mm	Approx. Overall Diameter Kg/Km
		DC at 20 °C	AC at 90 °C	Laid in ground	Laid in duct	Laid in free air (Shaded)		
		Ω/Km	Ω/Km	A	A	A		
4 core cables - CU/XLPE/STA/PVC								
CX1-T104-G09	6 RM	3.08	3.69	67	50	55	17	555
CX1-T104-G10	10 RM	1.83	2.19	89	67	75	18.4	725
CX1-T104-G11	16 RM	1.15	1.39	116	84	98	20.8	1005
CX1-T104-G12	25 RM	0.727	0.9273	153	113	131	24.3	1390
CX1-T104-G13	35 RM	0.524	0.6686	184	137	162	27	1795
CX1-T104-G14	50 SM	0.387	0.494	237	170	211	28.3	2210
CX1-T104-G15	70 SM	0.268	0.3425	290	211	267	32.8	3125
CX1-T104-G16	95 SM	0.193	0.2471	347	258	329	36.9	4510
CX1-T104-G17	120 SM	0.153	0.1964	395	296	384	41.2	5575
CX1-T104-G18	150 SM	0.124	0.1597	445	337	443	45.7	6755
CX1-T104-G19	185 SM	0.0991	0.1284	504	388	513	50.7	8365
CX1-T104-G20	240 SM	0.0754	0.0988	584	453	610	56.5	10700
CX1-T104-G30	300 SM	0.0601	0.0799	659	518	704	62.1	13190
CX1-T104-G40	400 SM	0.047	0.0641	750	601	825	70.9	16885
CX1-T104-G50	500 SM	0.0366	0.0518	850	689	958	79.8	22155
4 core cables with reduced neutral - CU/XLPE/STA/PVC								
CX1-T105-G12	25RM / 16RM	0.727 / 1.15	0.9273 / 1.4666	152	112	130	23.4	1285
CX1-T105-G13	35RM / 16RM	0.524 / 1.15	0.6686 / 1.4666	182	135	158	25.4	1595
CX1-T105-G14	50SM / 25RM	0.387 / 0.727	0.494 / 0.9273	223	164	198	28.3	2035
CX1-T105-G15	70SM / 35RM	0.268 / 0.524	0.3425 / 0.6686	272	203	249	33	2865
CX1-T105-G16	95SM / 50SM	0.193 / 0.387	0.2471 / 0.494	347	255	328	36.2	4035
CX1-T105-G17	120SM / 70SM	0.153 / 0.268	0.1964 / 0.3425	394	292	378	39.1	5000
CX1-T105-G18	150SM / 70SM	0.124 / 0.268	0.1597 / 0.3425	441	331	433	43.3	5945
CX1-T105-G19	185SM / 95SM	0.0991 / 0.193	0.1284 / 0.2471	499	381	502	48.2	7425
CX1-T105-G20	240SM / 120SM	0.0754 / 0.153	0.0988 / 0.1964	578	449	597	53.7	9440
CX1-T105-G30	300SM / 150SM	0.0601 / 0.124	0.0799 / 0.1597	653	510	689	58.8	11580
CX1-T105-G40	400SM / 185SM	0.047 / 0.0991	0.0641 / 0.1284	743	592	806	66.7	14745
CX1-T105-G50	500SM / 240SM	0.0366 / 0.0754	0.0518 / 0.0988	838	675	930	74.1	18735

The above data is approximate and subjected to manufacturing tolerance.

rm: Round, Stranded
sm: Sector, Stranded

0.6/1 (1.2) KV Multi Core STA Cables

Multicore Cables, with Stranded Aluminium Conductors, XLPE Insulated, Steel Tape Armoured and PVC Sheathed



Description

- Multicore cables of stranded Aluminium conductors are insulated with XLPE compound, assembled together, armoured with steel tape and covered with an overall jacket of PVC compound.
- Cables are produced according to IEC 60502.

Application

- For outdoor installations in damp wet locations where mechanical damages are expected to occur.

Product Code	Nominal Cross sectional area mm ²	Maximum Conductor Resistance		Current Rating			Approx. Overall Diameter mm	Approx. Overall Diameter Kg/Km
		DC at 20 °C Ω/Km	AC at 90 °C Ω/Km	Laid in ground A	Laid in duct A	Laid in free air (Shaded) A		
2 core cables - AL/XLPE/STA/PVC								
AX1-T102-G11	16 RM	1.91	2.4489	111	80	90	18.1	430
AX1-T102-G12	25 RM	1.2	1.5387	144	105	120	21.1	565
AX1-T102-G13	35 RM	0.868	1.1131	173	126	148	23.3	680
AX1-T102-G14	50 RM	0.641	0.8221	206	151	180	26.3	830
AX1-T102-G15	70 RM	0.443	0.5684	254	189	227	30.1	1060
AX1-T102-G16	95 RM	0.32	0.4109	303	229	278	33.7	1330
AX1-T102-G17	120 RM	0.253	0.3251	347	265	326	38.3	1955
AX1-T102-G18	150 RM	0.206	0.2651	388	299	371	42.1	2325
AX1-T102-G19	185 RM	0.164	0.2114	439	344	428	46.9	2810
AX1-T102-G20	240 RM	0.125	0.1618	510	403	507	52.3	3440
AX1-T102-G30	300 RM	0.1	0.1302	577	462	585	57.9	4155
AX1-T102-G40	400 RM	0.0778	0.1023	660	535	681	64.5	5100
3 core cables - AL/XLPE/STA/PVC								
AX1-T103-G11	16 RM	1.91	2.4489	91	65	74	19.1	500
AX1-T103-G12	25 RM	1.2	1.5387	117	86	99	22.3	675
AX1-T103-G13	35 RM	0.868	1.1131	141	104	121	24.7	820
AX1-T103-G14	50 SM	0.641	0.8221	178	127	154	24.6	855
AX1-T103-G15	70 SM	0.443	0.5684	218	158	195	28.5	1145
AX1-T103-G16	95 SM	0.32	0.4109	262	191	240	32	1460
AX1-T103-G17	120 SM	0.253	0.3252	301	222	285	36.6	2090
AX1-T103-G18	150 SM	0.206	0.2651	335	251	323	39.9	2525
AX1-T103-G19	185 SM	0.164	0.2115	381	289	375	43.9	2980
AX1-T103-G20	240 SM	0.125	0.1619	443	340	447	49.2	3745
AX1-T103-G30	300 SM	0.1	0.1302	502	390	517	53.9	4440
AX1-T103-G40	400 SM	0.0778	0.1023	578	455	613	61.1	5670
AX1-T103-G50	500 SM	0.0605	0.0809	659	526	715	67.8	7005

The above data is approximate and subjected to manufacturing tolerance.

rm: Round, Stranded
sm: Sector, Stranded

» Cont'd

0.6/1 (1.2) KV Multi Core STA Cables

Multicore Cables, with Stranded Aluminium Conductors, XLPE Insulated, Steel Tape Armoured and PVC Sheathed



Product Code	Nominal Cross sectional area mm ²	Maximum Conductor Resistance		Current Rating			Approx. Overall Diameter mm	Approx. Overall Diameter Kg/Km
		DC at 20 °C	AC at 90 °C	Laid in ground	Laid in duct	Laid in free air (Shaded)		
		Ω/Km	Ω/Km	A	A	A		
4 core cables - AL/XLPE/STA/PVC								
AX1-T104-G11	16 RM	1.91	2.4489	92	67	77	20.7	580
AX1-T104-G12	25 RM	1.2	1.5387	119	88	102	24.3	795
AX1-T104-G13	35 RM	0.868	1.1131	143	106	125	27	975
AX1-T104-G14	50 SM	0.641	0.8221	184	132	164	28.3	1090
AX1-T104-G15	70 SM	0.443	0.5684	225	164	208	32.8	1465
AX1-T104-G16	95 SM	0.32	0.4109	269	200	255	36.9	2180
AX1-T104-G17	120 SM	0.253	0.3252	307	231	298	41.2	2650
AX1-T104-G18	150 SM	0.206	0.2651	346	262	344	45.7	3195
AX1-T104-G19	185 SM	0.164	0.2115	393	302	400	50.7	3820
AX1-T104-G20	240 SM	0.125	0.1619	457	355	478	56.5	4755
AX1-T104-G30	300 SM	0.1	0.1302	518	407	553	62.1	5695
AX1-T104-G40	400 SM	0.0778	0.1023	596	477	654	70.9	7365
AX1-T104-G50	500 SM	0.0605	0.0809	682	553	769	79.8	9820
4 core cables with reduced neutral - AL/XLPE/STA/PVC								
AX1-T105-G12	25RM / 16RM	1.2 / 1.91	1.5387 / 2.4489	118	87	101	23.4	745
AX1-T105-G13	35RM / 16RM	0.868 / 1.91	1.1131 / 2.4489	141	104	123	25.4	885
AX1-T105-G14	50SM / 25RM	0.641 / 1.2	0.8221 / 1.5387	173	127	154	28.3	1050
AX1-T105-G15	70SM / 35RM	0.443 / 0.868	0.5684 / 1.1131	211	158	193	33	1410
AX1-T105-G16	95SM / 50SM	0.32 / 0.641	0.4109 / 0.8221	269	198	254	36.2	2005
AX1-T105-G17	120SM / 70SM	0.253 / 0.443	0.3252 / 0.5684	306	227	294	39.1	2390
AX1-T105-G18	150SM / 70SM	0.206 / 0.443	0.2651 / 0.5684	342	257	336	43.3	2860
AX1-T105-G19	185SM / 95SM	0.164 / 0.32	0.2115 / 0.4109	389	297	391	48.2	3435
AX1-T105-G20	240SM / 120SM	0.125 / 0.253	0.1619 / 0.3252	453	351	467	53.7	4255
AX1-T105-G30	300SM / 150SM	0.1 / 0.206	0.1302 / 0.2651	513	401	541	58.8	5085
AX1-T105-G40	400SM / 185SM	0.0778 / 0.164	0.1023 / 0.2115	590	470	640	66.7	6470
AX1-T105-G50	500SM / 240SM	0.0605 / 0.125	0.0809 / 0.1619	673	543	747	74.1	8010

The above data is approximate and subjected to manufacturing tolerance.

rm: Round, Stranded
sm: Sector, Stranded

0.6/1 (1.2) KV Multi Core SWA Cables

Multicore Cables, with Stranded Copper Conductors, XLPE Insulated, Steel Wire Armoured and PVC Sheathed



Description

- Multicore cables of stranded Copper conductors are insulated with XLPE compound, assembled together, armoured with steel wires and covered with an overall jacket of PVC compound.
- Cables are produced according to IEC 60502 or BS 5467.

Application

- For outdoor installations in damp wet locations where mechanical damages are expected to occur.

Product Code	Nominal Cross sectional area mm ²	Maximum Conductor Resistance		Current Rating			Approx. Overall Diameter mm	Approx. Overall Diameter Kg/Km
		DC at 20 °C Ω/Km	AC at 90 °C Ω/Km	Laid in ground A	Laid in duct A	Laid in free air (Shaded) A		
2 core cables - CU/XLPE/SWA/PVC								
CX1-T102-W08	4 RM	4.61	5.54	68	52	55	14.6	410
CX1-T102-W09	6 RM	3.08	3.69	86	67	71	15.8	500
CX1-T102-W10	10 RM	1.83	2.19	111	88	93	17.7	700
CX1-T102-W11	16 RM	1.15	1.39	143	106	123	19.8	900
CX1-T102-W12	25 RM	0.727	0.9272	187	139	161	24.4	1335
CX1-T102-W13	35 RM	0.524	0.6685	226	166	198	26.6	1620
CX1-T102-W14	50 SM	0.387	0.4938	274	198	240	26.2	1750
CX1-T102-W15	70 SM	0.268	0.3423	332	243	296	28.6	2255
CX1-T102-W16	95 SM	0.193	0.2469	402	297	369	32.9	3105
CX1-T102-W17	120 SM	0.153	0.1961	458	341	430	36.4	3735
CX1-T102-W18	150 SM	0.124	0.1593	512	385	488	39	4365
CX1-T102-W19	185 SM	0.0991	0.1279	580	444	569	45.2	5790
CX1-T102-W20	240 SM	0.0754	0.0982	667	515	666	49.3	7105
CX1-T102-W30	300 SM	0.0601	0.0792	746	580	756	52.5	8455
CX1-T102-W40	400 SM	0.047	0.0632	839	662	868	58.4	10495
3 core cables - CU/XLPE/SWA/PVC								
CX1-T103-W08	4 RM	4.61	5.54	54	41	46	15.3	465
CX1-T103-W09	6 RM	3.08	3.69	67	51	56	16.6	570
CX1-T103-W10	10 RM	1.83	2.19	88	68	76	18.5	810
CX1-T103-W11	16 RM	1.15	1.39	114	84	99	20.7	1065
CX1-T103-W12	25 RM	0.727	0.9273	152	113	132	25.6	1620
CX1-T103-W13	35 RM	0.524	0.6686	183	137	162	28	1990
CX1-T103-W14	50 SM	0.387	0.494	232	168	206	28.1	2265
CX1-T103-W15	70 SM	0.268	0.3425	286	209	262	32.4	3205
CX1-T103-W16	95 SM	0.193	0.2471	342	253	322	35.9	4135
CX1-T103-W17	120 SM	0.153	0.1964	390	290	375	39.1	4945
CX1-T103-W18	150 SM	0.124	0.1597	434	330	426	43.6	6330
CX1-T103-W19	185 SM	0.0991	0.1284	490	375	490	47.6	7625
CX1-T103-W20	240 SM	0.0754	0.0988	565	436	579	52.7	9580
CX1-T103-W30	300 SM	0.0601	0.0799	634	496	663	57.6	11615
CX1-T103-W40	400 SM	0.047	0.0641	715	567	769	64.8	14570
CX1-T103-W50	500 SM	0.0366	0.0518	791	635	872	73	19020

The above data is approximate and subjected to manufacturing tolerance.

rm: Round, Stranded
sm: Sector, Stranded

» Cont'd

0.6/1 (1.2) KV Multi Core SWA Cables

Multicore Cables, with Stranded Copper Conductors, XLPE Insulated, Steel Wire Armoured and PVC Sheathed



Product Code	Nominal Cross sectional area mm ²	Maximum Conductor Resistance		Current Rating			Approx. Overall Diameter mm	Approx. Overall Diameter Kg/Km
		DC at 20 °C	AC at 90 °C	Laid in ground	Laid in duct	Laid in free air (Shaded)		
		Ω/Km	Ω/Km	A	A	A		
4 core cables - CU/XLPE/SWA/PVC								
CX1-T104-W08	4 RM	4.61	5.54	54	42	47	16.3	535
CX1-T104-W09	6 RM	3.08	3.69	68	52	57	18.4	765
CX1-T104-W10	10 RM	1.83	2.19	90	69	77	19.8	950
CX1-T104-W11	16 RM	1.15	1.39	115	86	101	23	1390
CX1-T104-W12	25 RM	0.727	0.9273	154	116	136	27.6	1945
CX1-T104-W13	35 RM	0.524	0.6686	185	140	166	30.5	2435
CX1-T104-W14	50 SM	0.387	0.494	238	174	218	31.8	2860
CX1-T104-W15	70 SM	0.268	0.3425	293	218	277	36.9	4095
CX1-T104-W16	95 SM	0.193	0.2471	350	260	337	39.4	5195
CX1-T104-W17	120 SM	0.153	0.1964	397	301	393	44.9	6770
CX1-T104-W18	150 SM	0.124	0.1597	446	341	451	49.4	8090
CX1-T104-W19	185 SM	0.0991	0.1284	503	390	521	54.2	9805
CX1-T104-W20	240 SM	0.0754	0.0988	579	456	614	60.2	12320
CX1-T104-W30	300 SM	0.0601	0.0799	649	513	702	65.8	14975
CX1-T104-W40	400 SM	0.047	0.0641	725	584	810	75.9	19775
CX1-T104-W50	500 SM	0.0366	0.0518	806	659	920	83.4	24540
4 core cables with reduced neutral - CU/XLPE/SWA/PVC								
CX1-T105-W12	25RM / 16RM	0.727 / 1.15	0.9273 / 1.4666	153	115	134	26.7	1815
CX1-T105-W13	35RM / 16RM	0.524 / 1.15	0.6686 / 1.4666	184	138	163	28.7	2180
CX1-T105-W14	50SM / 25RM	0.387 / 0.727	0.494 / 0.9273	225	168	204	31.8	2700
CX1-T105-W15	70SM / 35RM	0.268 / 0.524	0.3425 / 0.6686	275	210	257	36.9	3835
CX1-T105-W16	95SM / 50SM	0.193 / 0.387	0.2471 / 0.494	349	259	335	38.9	4720
CX1-T105-W17	120SM / 70SM	0.153 / 0.268	0.1964 / 0.3425	395	296	386	41.8	5750
CX1-T105-W18	150SM / 70SM	0.124 / 0.268	0.1597 / 0.3425	442	338	442	47	7190
CX1-T105-W19	185SM / 95SM	0.0991 / 0.193	0.1284 / 0.2471	498	384	510	51.9	8805
CX1-T105-W20	240SM / 120SM	0.0754 / 0.153	0.0988 / 0.1964	575	449	602	57.4	10975
CX1-T105-W30	300SM / 150SM	0.0601 / 0.124	0.0799 / 0.1597	644	507	689	62.5	13285
CX1-T105-W40	400SM / 185SM	0.047 / 0.0991	0.0641 / 0.1284	723	578	798	71.5	17405
CX1-T105-W50	500SM / 240SM	0.0366 / 0.0754	0.0518 / 0.0988	800	648	902	79.3	21805

The above data is approximate and subjected to manufacturing tolerance.

rm: Round, Stranded
sm: Sector, Stranded

0.6/1 (1.2) KV Multi Core SWA Cables

Multicore Cables, with Stranded, Aluminium Conductors, XLPE Insulated, Steel Wire Armoured and PVC Sheathed



Description

- Multicore cables of stranded Aluminium conductors are insulated with XLPE compound, assembled together, armoured with steel wire and covered with an overall jacket of PVC compound.
- Cables are produced according to IEC 60502.

Application

- For outdoor installations in damp wet locations where mechanical damages are expected to occur.

Product Code	Nominal Cross sectional area mm ²	Maximum Conductor Resistance		Current Rating			Approx. Overall Diameter mm	Approx. Overall Diameter Kg/Km
		DC at 20 °C Ω/Km	AC at 90 °C Ω/Km	Laid in ground A	Laid in duct A	Laid in free air (Shaded) A		
2 core cables - AL/XLPE/SWA/PVC								
AX1-T102-W11	16 RM	1.91	2.4489	113	82	94	20.3	695
AX1-T102-W12	25 RM	1.2	1.5387	146	108	125	24.4	1035
AX1-T102-W13	35 RM	0.868	1.1131	175	129	153	26.6	1210
AX1-T102-W14	50 RM	0.641	0.8221	208	155	186	29.6	1420
AX1-T102-W15	70 RM	0.443	0.5684	255	193	233	33.6	1765
AX1-T102-W16	95 RM	0.32	0.4109	306	233	286	37.6	2325
AX1-T102-W17	120 RM	0.253	0.3251	348	268	331	41	2690
AX1-T102-W18	150 RM	0.206	0.2651	389	302	376	44.6	3105
AX1-T102-W19	185 RM	0.164	0.2114	439	347	434	50.6	4160
AX1-T102-W20	240 RM	0.125	0.1618	509	405	512	56	4955
AX1-T102-W30	300 RM	0.1	0.1302	574	462	588	61.4	5800
AX1-T102-W40	400 RM	0.0778	0.1023	652	531	680	68.2	6965
3 core cables - AL/XLPE/SWA/PVC								
AX1-T103-W11	16 RM	1.91	2.4489	92	67	77	21.3	780
AX1-T103-W12	25 RM	1.2	1.5387	118	88	103	25.6	1170
AX1-T103-W13	35 RM	0.868	1.1131	142	106	125	28	1375
AX1-T103-W14	50 SM	0.641	0.8221	180	130	160	28.1	1420
AX1-T103-W15	70 SM	0.443	0.5684	222	162	204	32.4	1960
AX1-T103-W16	95 SM	0.32	0.4109	266	196	250	35.9	2385
AX1-T103-W17	120 SM	0.253	0.3252	304	226	292	39.1	2755
AX1-T103-W18	150 SM	0.206	0.2651	338	257	332	43.6	3660
AX1-T103-W19	185 SM	0.164	0.2115	383	294	383	47.6	4220
AX1-T103-W20	240 SM	0.125	0.1619	445	343	455	52.7	5125
AX1-T103-W30	300 SM	0.1	0.1302	501	392	524	57.6	5980
AX1-T103-W40	400 SM	0.0778	0.1023	573	454	616	64.8	7430
AX1-T103-W50	500 SM	0.0605	0.0809	646	519	711	73	9780

The above data is approximate and subjected to manufacturing tolerance.

rm: Round, Stranded
sm: Sector, Stranded

» Cont'd

0.6/1 (1.2) KV Multi Core SWA Cables

Multicore Cables, with Stranded, Aluminium Conductors, XLPE Insulated, Steel Wire Armoured and PVC Sheathed



Product Code	Nominal Cross sectional area mm ²	Maximum Conductor Resistance		Current Rating			Approx. Overall Diameter mm	Approx. Overall Diameter Kg/Km
		DC at 20 °C	AC at 90 °C	Laid in ground	Laid in duct	Laid in free air (Shaded)		
		Ω/Km	Ω/Km	A	A	A		
4 core cables - AL/XLPE/SWA/PVC								
AX1-T104-W11	16 RM	1.91	2.4489	93	69	80	24	1040
AX1-T104-W12	25 RM	1.2	1.5387	120	90	105	27.6	1350
AX1-T104-W13	35 RM	0.868	1.1131	144	109	129	30.5	1615
AX1-T104-W14	50 SM	0.641	0.8221	185	135	169	31.8	1740
AX1-T104-W15	70 SM	0.443	0.5684	228	169	215	36.9	2430
AX1-T104-W16	95 SM	0.32	0.4109	272	202	262	39.4	2870
AX1-T104-W17	120 SM	0.253	0.3252	309	235	306	44.9	3850
AX1-T104-W18	150 SM	0.206	0.2651	348	266	352	49.4	4530
AX1-T104-W19	185 SM	0.164	0.2115	394	306	408	54.2	5260
AX1-T104-W20	240 SM	0.125	0.1619	456	359	483	60.2	6375
AX1-T104-W30	300 SM	0.1	0.1302	514	407	556	65.8	7480
AX1-T104-W40	400 SM	0.0778	0.1023	585	471	653	75.9	10255
AX1-T104-W50	500 SM	0.0605	0.0809	661	541	754	83.4	12205
4 core cables with reduced neutral - AL/XLPE/SWA/PVC								
AX1-T105-W12	25RM/16RM	1.2 / 1.91	1.5387 / 2.4489	119	89	104	26.7	1270
AX1-T105-W13	35RM/16RM	0.868 / 1.91	1.1131 / 2.4489	143	107	127	28.7	1470
AX1-T105-W14	50SM/25RM	0.641 / 1.2	0.8221 / 1.5387	174	130	158	31.8	1710
AX1-T105-W15	70SM/35RM	0.443 / 0.868	0.5684 / 1.1131	214	163	200	36.9	2385
AX1-T105-W16	95SM/50SM	0.32 / 0.641	0.4109 / 0.8221	271	201	260	38.9	2695
AX1-T105-W17	120SM/70SM	0.253 / 0.443	0.3252 / 0.5684	308	231	300	41.8	3140
AX1-T105-W18	150SM/70SM	0.206 / 0.443	0.2651 / 0.5684	344	263	345	47	4105
AX1-T105-W19	185SM/95SM	0.164 / 0.32	0.2115 / 0.4109	390	301	399	51.9	4815
AX1-T105-W20	240SM/120SM	0.125 / 0.253	0.1619 / 0.3252	452	354	474	57.4	5790
AX1-T105-W30	300SM/150SM	0.1 / 0.206	0.1302 / 0.2651	510	401	546	62.5	6790
AX1-T105-W40	400SM/185SM	0.0778 / 0.164	0.1023 / 0.2115	582	466	642	71.5	9130
AX1-T105-W50	500SM/240SM	0.0605 / 0.125	0.0809 / 0.1619	655	531	738	79.3	11080

The above data is approximate and subjected to manufacturing tolerance.

rm: Round, Stranded
sm: Sector, Stranded

1.8/3 (3.6) KV Single Core Unarmoured Cables

Single Core Cables, with stranded Circular copper or Aluminum conductors, PVC insulated, copper tape shield and PVC Sheath



Description

- Soft stranded copper or aluminum conductor, insulated with PVC compound rated 70 °C Shielded with copper tape and sheathed with PVC compound layer.
- Cable are produced according to IEC 60502.

Application

- For outdoor and indoor installation in damp and wet locations. They are normally used for power distribution in urban networks, industrial plants, as well as in the thermopower and hydropower stations.

Product Code	Nominal Cross sectional area	Maximum Conductor Resistance		Current Rating						Approx. Overall Diameter	Approx. Weight
		DC at 20 °C	AC at 70 °C	Laid in ground			Laid in free air (Shaded)				
				Flat	Trefoil	Duct	Flat Separated	Flat Touched	Trefoil Touched		
		mm ²	Ω/Km	Ω/Km	A	A	A	A	A		
1 Core - Cu/PVC/PVC											
CPA-T101-U12	25	0.727	0.87	141	143	105	145	117	114	13	410
CPA-T101-U13	35	0.524	0.6272	170	172	127	178	144	140	14.1	515
CPA-T101-U14	50	0.387	0.4634	201	204	151	216	175	171	15.6	650
CPA-T101-U15	70	0.268	0.3213	246	250	187	272	221	215	17.2	860
CPA-T101-U16	95	0.193	0.2318	295	299	226	332	271	263	18.9	1130
CPA-T101-U17	120	0.153	0.1843	335	340	259	385	315	306	20.3	1380
CPA-T101-U18	150	0.124	0.1499	376	382	293	440	360	350	21.9	1660
CPA-T101-U19	185	0.0991	0.1206	424	431	334	508	416	404	23.6	2010
CPA-T101-U20	240	0.0754	0.093	491	499	390	604	496	481	26.2	2575
CPA-T101-U30	300	0.0601	0.0754	552	562	447	697	574	557	29.2	3195
CPA-T101-U40	400	0.047	0.0607	623	635	512	807	665	646	32.4	4070
CPA-T101-U50	500	0.0366	0.0494	700	716	588	936	771	750	36.4	5185
CPA-T101-U60	630	0.0283	0.0409	780	799	664	1079	882	859	40.1	6500
CPA-T101-U70	800	0.0221	0.0349	856	879	742	1231	998	972	44.6	8390
CPA-T101-U80	1000	0.0176	0.0307	930	959	830	1396	1129	1102	52.1	10495
1 Core - AL/PVC/PVC											
APA-T101-U11	16	1.91	2.2949	85	86	62	85	69	67	11.9	215
APA-T101-U12	25	1.2	1.4419	110	111	81	113	91	89	13	260
APA-T101-U13	35	0.868	1.0431	132	133	98	138	112	109	14.1	310
APA-T101-U14	50	0.641	0.7704	156	158	118	168	136	132	15.6	370
APA-T101-U15	70	0.443	0.5326	191	194	145	211	172	167	17.2	455
APA-T101-U16	95	0.32	0.385	229	232	175	258	210	205	18.9	555
APA-T101-U17	120	0.253	0.3047	261	265	202	300	245	238	20.3	655
APA-T101-U18	150	0.206	0.2485	292	297	228	342	280	272	21.9	765
APA-T101-U19	185	0.164	0.1983	331	337	261	396	325	315	23.6	895
APA-T101-U20	240	0.125	0.1519	384	391	306	472	388	376	26.1	1110
APA-T101-U30	300	0.1	0.1223	434	442	351	545	451	438	29.1	1365
APA-T101-U40	400	0.0778	0.0963	496	505	407	638	529	514	32.4	1710
APA-T101-U50	500	0.0605	0.0764	565	577	474	747	622	604	36.3	2120
APA-T101-U60	630	0.0469	0.0611	640	655	544	872	724	703	40	2630
APA-T101-U70	800	0.0367	0.0502	719	737	625	1016	840	817	45	3300
APA-T101-U80	1000	0.0291	0.0424	797	819	709	1171	966	941	52.1	4100

The above data is approximate and subjected to manufacturing tolerance.

1.8/3 (3.6) KV Single Core ATA Cables

Single Core Cables, With Stranded Copper or Aluminum Conductors, PVC insulation, Aluminum Tape Armoured, and PVC Sheathed.



Description

- Soft annealed copper or Aluminum conductor, insulated with PVC compound rated 70 °C, Aluminum Tape Armoured and sheathed with PVC compound layer.
- Cables are produced according to IEC 60502.

Application

- For outdoor and indoor installation in damp and wet locations where mechanical damages are expected to occur.

Product Code	Nominal Cross sectional area	Maximum Conductor Resistance		Current Rating						Approx. Overall Diameter	Approx. Weight
		DC at 20 °C	AC at 70 °C	Laid in ground			Laid in free air (Shaded)				
				Flat	Trefoil	Duct	Flat Separated	Flat Touched	Trefoil Touched		
mm ²	Ω/Km	Ω/Km	A	A	A	A	A	A	mm	Kg/Km	
1 Core - Cu/PVC/ATA/PVC											
CPA-T101-B12	25	0.727	0.87	142	144	109	150	125	122	16.8	535
CPA-T101-B13	35	0.524	0.6272	170	172	132	183	153	149	17.9	650
CPA-T101-B14	50	0.387	0.4634	202	205	157	222	185	180	19.2	785
CPA-T101-B15	70	0.268	0.3212	247	251	193	277	231	225	20.8	1010
CPA-T101-B16	95	0.193	0.2317	295	300	233	337	282	274	22.3	1280
CPA-T101-B17	120	0.153	0.1841	335	340	266	389	325	317	23.7	1540
CPA-T101-B18	150	0.124	0.1497	375	382	300	442	371	361	25.1	1820
CPA-T101-B19	185	0.0991	0.1203	423	431	341	507	426	415	26.8	2185
CPA-T101-B20	240	0.0754	0.0926	487	498	397	598	504	492	29.4	2765
CPA-T101-B30	300	0.0601	0.075	546	560	453	683	579	566	32.2	3385
CPA-T101-B40	400	0.047	0.0601	613	631	520	778	667	654	36	4330
CPA-T101-B50	500	0.0366	0.0488	685	708	591	887	766	754	40	5475
CPA-T101-B60	630	0.0283	0.0402	757	788	667	1004	870	859	43.5	6800
CPA-T101-B70	800	0.0221	0.034	825	863	742	1118	974	967	48.4	8770
CPA-T101-B80	1000	0.0176	0.0298	885	934	820	1233	1086	1084	55.9	10935
1 Core - AL/PVC/ATA/PVC											
APA-T101-B11	16	1.91	2.2949	86	87	66	89	74	72	15.7	335
APA-T101-B12	25	1.2	1.4419	110	112	85	117	97	95	16.8	390
APA-T101-B13	35	0.868	1.043	132	134	102	142	119	116	17.9	445
APA-T101-B14	50	0.641	0.7704	157	159	122	172	143	140	19.2	505
APA-T101-B15	70	0.443	0.5326	192	195	150	216	180	175	20.8	605
APA-T101-B16	95	0.32	0.3849	229	233	181	263	219	213	22.3	710
APA-T101-B17	120	0.253	0.3046	261	265	207	304	254	247	23.7	815
APA-T101-B18	150	0.206	0.2483	292	297	234	346	289	281	25.1	925
APA-T101-B19	185	0.164	0.1981	331	337	267	398	333	325	26.8	1070
APA-T101-B20	240	0.125	0.1517	383	391	312	471	396	385	29.3	1295
APA-T101-B30	300	0.1	0.1221	432	441	357	541	457	446	32.1	1555
APA-T101-B40	400	0.0778	0.0959	491	503	415	624	534	521	36	1970
APA-T101-B50	500	0.0605	0.0759	556	572	478	722	622	609	39.9	2415
APA-T101-B60	630	0.0469	0.0606	627	648	546	831	719	705	43.4	2930
APA-T101-B70	800	0.0367	0.0495	699	726	624	949	826	814	48.8	3680
APA-T101-B80	1000	0.0291	0.0417	766	802	705	1068	939	930	55.9	4540

The above data is approximate and subjected to manufacturing tolerance.

1.8/3 (3.6) KV Single Core AWA Cables

Single Core Cables, With Stranded Copper or Aluminum Conductors, PVC insulation, Aluminum Wire Armoured, and PVC Sheathed.



Description

- Soft annealed copper or Aluminum conductor, insulated with PVC compound rated 70 °C, Aluminum Wire Armoured and sheathed with PVC compound layer.
- Cables are produced according to IEC 60502 or BS 6346.

Application

- For outdoor and indoor installation in damp and wet locations where mechanical damages are expected to occur.

Product Code	Nominal Cross sectional area	Maximum Conductor Resistance		Current Rating						Approx. Overall Diameter	Approx. Weight
		DC at 20 °C	AC at 70 °C	Laid in ground			Laid in free air (Shaded)				
				Flat	Trefoil	Duct	Flat Separated	Flat Touched	Trefoil Touched		
mm ²	Ω/Km	Ω/Km	A	A	A	A	A	A	mm	Kg/Km	
1 Core - Cu/PVC/AWA/PVC											
CPA-T101-X12	25	0.727	0.87	143	145	112	154	130	127	19.1	645
CPA-T101-X13	35	0.524	0.6272	171	174	135	187	158	154	20.2	765
CPA-T101-X14	50	0.387	0.4633	202	206	160	225	190	186	21.5	910
CPA-T101-X15	70	0.268	0.3211	247	251	196	279	237	232	23.1	1145
CPA-T101-X16	95	0.193	0.2316	293	300	235	337	287	281	24.6	1425
CPA-T101-X17	120	0.153	0.184	331	339	268	385	329	323	26	1695
CPA-T101-X18	150	0.124	0.1496	369	379	301	434	373	366	27.4	1980
CPA-T101-X19	185	0.0991	0.1202	413	426	340	491	425	419	29.1	2355
CPA-T101-X20	240	0.0754	0.0924	471	489	395	567	497	492	31.7	2955
CPA-T101-X30	300	0.0601	0.0747	517	542	444	628	561	559	34.8	3630
CPA-T101-X40	400	0.047	0.0598	569	602	499	697	634	637	38.4	4585
CPA-T101-X50	500	0.0366	0.0484	624	667	561	775	714	723	42.4	5740
CPA-T101-X60	630	0.0283	0.0397	674	729	619	848	792	810	46.1	7110
CPA-T101-X70	800	0.0221	0.0333	691	761	658	895	843	874	52	9290
CPA-T101-X80	1000	0.0176	0.0291	723	803	710	971	916	956	59.5	11530
1 Core - AL/PVC/AWA/PVC											
APA-T101-X11	16	1.91	2.2949	86	87	68	91	77	75	18	430
APA-T101-X12	25	1.2	1.4419	111	113	87	120	101	99	19.1	495
APA-T101-X13	35	0.868	1.043	133	135	105	146	123	120	20.2	560
APA-T101-X14	50	0.641	0.7703	158	160	124	176	148	144	21.5	630
APA-T101-X15	70	0.443	0.5325	193	196	153	219	185	180	23.1	740
APA-T101-X16	95	0.32	0.3849	229	234	183	265	224	219	24.6	850
APA-T101-X17	120	0.253	0.3045	260	266	210	305	258	253	26	970
APA-T101-X18	150	0.206	0.2482	290	297	236	344	293	287	27.4	1090
APA-T101-X19	185	0.164	0.198	327	336	268	393	336	330	29.1	1240
APA-T101-X20	240	0.125	0.1515	376	387	313	458	396	389	31.6	1485
APA-T101-X30	300	0.1	0.1219	418	434	355	516	452	446	34.7	1800
APA-T101-X40	400	0.0778	0.0957	469	490	406	584	520	516	38.4	2225
APA-T101-X50	500	0.0605	0.0757	523	551	464	660	596	596	42.3	2680
APA-T101-X60	630	0.0469	0.0603	578	615	523	739	676	681	46	3240
APA-T101-X70	800	0.0367	0.049	613	663	574	805	745	761	52.4	4200
APA-T101-X80	1000	0.0291	0.0411	655	715	633	887	825	848	59.5	5135

The above data is approximate and subjected to manufacturing tolerance.

1.8/3 (3.6) KV Multi Core Unarmoured Cables

Multi Core Cables, with stranded copper or Aluminum conductors, PVC insulated, copper tape shield and PVC Sheath.



Description

- Soft stranded copper or aluminum conductor, insulated with PVC compound rated 70 °C assembled together, Shielded with copper tape and sheathed with PVC compound layer.
- Cable are produced according to IEC 60502.

Application

- For outdoor and indoor installation in damp and wet locations. They are normally used for power distribution in urban networks, industrial plants, as well as in the thermopower and hydropower stations.

Product Code	Nominal Cross sectional area mm ²	Maximum Conductor Resistance		Current Rating			Approx. Overall Diameter mm	Approx. Overall Diameter Kg/Km
		DC at 20 °C Ω/Km	AC at 70 °C Ω/Km	Laid in ground A	Laid in duct A	Laid in free air (Shaded) A		
3 core cables - Cu/PVC/PVC								
CPA-T103-Z12	25 RM	0.727	0.8701	125	95	103	27.7	1325
CPA-T103-Z13	35 RM	0.524	0.6273	151	115	126	30.3	1670
CPA-T103-Z14	50 SM	0.387	0.4634	182	137	152	30.2	2035
CPA-T103-Z15	70 SM	0.268	0.3213	224	169	191	33.3	2740
CPA-T103-Z16	95 SM	0.193	0.2318	268	203	231	35.6	3555
CPA-T103-Z17	120 SM	0.153	0.1843	305	233	267	39	4340
CPA-T103-Z18	150 SM	0.124	0.1499	344	264	306	42.1	5190
CPA-T103-Z19	185 SM	0.0991	0.1205	389	301	351	45.5	6350
CPA-T103-Z20	240 SM	0.0754	0.0928	452	354	416	50.2	8130
CPA-T103-Z30	300 SM	0.0601	0.0752	509	402	477	55.5	10100
CPA-T103-Z40	400 SM	0.047	0.0603	579	463	555	62.9	12910
CPA-T103-Z50	500 SM	0.0366	0.0489	652	527	635	69.8	16390
3 core cables - AL/PVC/PVC								
APA-T103-Z11	16 RM	1.91	2.2949	75	57	61	25.4	725
APA-T103-Z12	25 RM	1.2	1.4419	97	74	80	27.7	880
APA-T103-Z13	35 RM	0.868	1.0431	117	90	98	30.3	1055
APA-T103-Z14	50 SM	0.641	0.7704	141	107	118	30.2	1195
APA-T103-Z15	70 SM	0.443	0.5326	174	131	148	33.3	1495
APA-T103-Z16	95 SM	0.32	0.385	208	157	179	35.6	1805
APA-T103-Z17	120 SM	0.253	0.3047	237	181	208	39	2150
APA-T103-Z18	150 SM	0.206	0.2484	267	205	238	42.1	2520
APA-T103-Z19	185 SM	0.164	0.1982	303	235	274	45.5	2950
APA-T103-Z20	240 SM	0.125	0.1518	354	277	325	50.2	3680
APA-T103-Z30	300 SM	0.1	0.1222	400	315	374	55.5	4445
APA-T103-Z40	400 SM	0.0778	0.0961	460	367	440	62.9	5770
APA-T103-Z50	500 SM	0.0605	0.076	524	423	510	69.8	7165

The above data is approximate and subjected to manufacturing tolerance.

rm: Round, Stranded
sm: Sector, Stranded

1.8/3 (3.6) KV Multi Core STA Cables

Multi Core Cables, with stranded copper or Aluminum conductors, PVC insulated, Steel tape Armoured and PVC Sheath.



Description

- Soft stranded copper or aluminum conductor, insulated with PVC compound rated 70 °C assembled together, Armoured with Steel tape and sheathed with PVC compound layer.
- Cable are produced according to IEC 60502.

Application

- For outdoor and indoor installation in damp and wet locations Where mechanical damage are expected to occur.

Product Code	Nominal Cross sectional area mm ²	Maximum Conductor Resistance		Current Rating			Approx. Overall Diameter mm	Approx. Overall Diameter Kg/Km
		DC at 20 °C Ω/Km	AC at 70 °C Ω/Km	Laid in ground A	Laid in duct A	Laid in free air (Shaded) A		
3 core cables - Cu/PVC/STA/PVC								
CPA-T103-G12	25 RM	0.727	0.8701	126	96	104	27.9	1425
CPA-T103-G13	35 RM	0.524	0.6273	151	116	126	30.5	1780
CPA-T103-G14	50 SM	0.387	0.4634	194	143	162	30.4	2105
CPA-T103-G15	70 SM	0.268	0.3213	240	178	207	34.7	3115
CPA-T103-G16	95 SM	0.193	0.2318	287	214	251	37	3960
CPA-T103-G17	120 SM	0.153	0.1843	327	246	291	40.4	4790
CPA-T103-G18	150 SM	0.124	0.1499	369	279	335	43.5	5675
CPA-T103-G19	185 SM	0.0991	0.1205	419	317	386	46.7	6835
CPA-T103-G20	240 SM	0.0754	0.0928	486	371	458	51.4	8660
CPA-T103-G30	300 SM	0.0601	0.0752	549	421	529	56.5	10665
CPA-T103-G40	400 SM	0.047	0.0603	625	489	618	63.9	13545
CPA-T103-G50	500 SM	0.0366	0.0489	703	556	711	70.6	17060
3 core cables - AL/PVC/STA/PVC								
APA-T103-G11	16 RM	1.91	2.2949	75	57	61	25.6	805
APA-T103-G12	25 RM	1.2	1.4419	98	74	80	27.9	980
APA-T103-G13	35 RM	0.868	1.0431	117	90	98	30.5	1170
APA-T103-G14	50 SM	0.641	0.7704	150	111	126	30.4	1265
APA-T103-G15	70 SM	0.443	0.5326	187	138	161	34.7	1870
APA-T103-G16	95 SM	0.32	0.385	223	166	195	37	2210
APA-T103-G17	120 SM	0.253	0.3047	255	191	227	40.4	2600
APA-T103-G18	150 SM	0.206	0.2484	287	217	260	43.5	3005
APA-T103-G19	185 SM	0.164	0.1982	327	248	301	46.7	3435
APA-T103-G20	240 SM	0.125	0.1518	381	291	359	51.4	4210
APA-T103-G30	300 SM	0.1	0.1222	432	332	416	56.5	5010
APA-T103-G40	400 SM	0.0778	0.0961	497	389	492	63.9	6405
APA-T103-G50	500 SM	0.0605	0.076	567	449	573	70.6	7835

The above data is approximate and subjected to manufacturing tolerance.

rm: Round, Stranded
sm: Sector, Stranded

1.8/3 (3.6) KV Multi Core SWA Cables

Multi Core Cables, with stranded copper or Aluminum conductors, PVC insulated, Steel wire Armoured and PVC Sheath.



Description

- Soft stranded copper or aluminum conductor, insulated with PVC compound rated 70 °C assembled together, Armoured with Steel wire and sheathed with PVC compound layer.
- Cable are produced according to IEC 60502, BS 6346.

Application

- for outdoor and indoor installation in damp and wet locations Where mechanical damage are expected to occur.

Product Code	Nominal Cross sectional area mm ²	Maximum Conductor Resistance		Current Rating			Approx. Overall Diameter mm	Approx. Overall Diameter Kg/Km
		DC at 20 °C Ω/Km	AC at 70 °C Ω/Km	Laid in ground A	Laid in duct A	Laid in free air (Shaded) A		
3 core cables - Cu/PVC/SWA/PVC								
CPA-T103-W12	25 RM	0.727	0.8701	126	97	106	31.4	2075
CPA-T103-W13	35 RM	0.524	0.6273	152	118	129	34	2485
CPA-T103-W14	50 SM	0.387	0.4634	196	146	169	34.3	2990
CPA-T103-W15	70 SM	0.268	0.3213	242	181	212	37.4	3775
CPA-T103-W16	95 SM	0.193	0.2318	289	216	256	39.5	4645
CPA-T103-W17	120 SM	0.153	0.1843	329	249	299	44.1	5960
CPA-T103-W18	150 SM	0.124	0.1499	371	282	342	47.2	6920
CPA-T103-W19	185 SM	0.0991	0.1205	419	320	392	50.4	8160
CPA-T103-W20	240 SM	0.0754	0.0928	484	372	463	55.1	10115
CPA-T103-W30	300 SM	0.0601	0.0752	542	422	529	60.4	12315
CPA-T103-W40	400 SM	0.047	0.0603	608	479	613	68.9	16155
CPA-T103-W50	500 SM	0.0366	0.0489	675	537	693	75.8	19925
3 core cables - AL/PVC/SWA/PVC								
APA-T103-W11	16 RM	1.91	2.2949	76	58	63	28.9	1385
APA-T103-W12	25 RM	1.2	1.4419	98	76	82	31.4	1625
APA-T103-W13	35 RM	0.868	1.0431	118	91	100	34	1875
APA-T103-W14	50 SM	0.641	0.7704	152	114	131	34.3	2145
APA-T103-W15	70 SM	0.443	0.5326	188	141	164	37.4	2530
APA-T103-W16	95 SM	0.32	0.385	225	168	199	39.5	2895
APA-T103-W17	120 SM	0.253	0.3047	257	195	233	44.1	3770
APA-T103-W18	150 SM	0.206	0.2484	289	220	266	47.2	4250
APA-T103-W19	185 SM	0.164	0.1982	328	251	307	50.4	4760
APA-T103-W20	240 SM	0.125	0.1518	381	293	365	55.1	5665
APA-T103-W30	300 SM	0.1	0.1222	430	335	419	60.4	6660
APA-T103-W40	400 SM	0.0778	0.0961	491	386	493	68.9	9015
APA-T103-W50	500 SM	0.0605	0.076	553	440	568	75.8	10705

The above data is approximate and subjected to manufacturing tolerance.

rm: Round, Stranded
sm: Sector, Stranded

1.8/3 (3.6) KV Single core Unarmoured Cables

Single Core Cables, with stranded Circular copper or Aluminum conductors, XLPE insulated, copper tape shield and PVC Sheath.



Description

- Soft stranded copper or aluminum conductor, insulated with XLPE compound rated 90 °C Shielded with copper tape and sheathed with PVC compound layer.
- Cable are produced according to IEC 60502.

Application

- For outdoor and indoor installation in damp and wet locations. They are normally used for power distribution in urban networks, industrial plants, as well as in the thermopower and hydropower stations.

Product Code	Nominal Cross sectional area	Maximum Conductor Resistance		Current Rating						Approx. Overall Diameter	Approx. Weight
		DC at 20 °C	AC at 90 °C	Laid in ground			Laid in free air (Shaded)				
				Flat	Trefoil	Duct	Flat Separated	Flat Touched	Trefoil Touched		
mm ²	Ω/Km	Ω/Km	A	A	A	A	A	A	mm	Kg/Km	
1 Core - Cu/XLPE/PVC											
CXA-T101-U12	25	0.727	0.9272	166	168	123	185	148	144	12.6	365
CXA-T101-U13	35	0.524	0.6684	199	202	148	227	182	177	13.7	460
CXA-T101-U14	50	0.387	0.4939	236	239	177	275	221	215	15	585
CXA-T101-U15	70	0.268	0.3423	289	293	219	346	279	271	16.8	795
CXA-T101-U16	95	0.193	0.247	345	350	264	423	342	332	18.3	1050
CXA-T101-U17	120	0.153	0.1963	391	397	304	490	397	386	19.9	1300
CXA-T101-U18	150	0.124	0.1596	439	446	344	560	455	441	21.3	1565
CXA-T101-U19	185	0.0991	0.1283	495	504	392	646	526	510	23.2	1920
CXA-T101-U20	240	0.0754	0.0988	573	583	462	769	627	609	25.8	2475
CXA-T101-U30	300	0.0601	0.0801	645	657	528	889	725	704	28.2	3040
CXA-T101-U40	400	0.047	0.0645	728	743	602	1032	841	816	31	3865
CXA-T101-U50	500	0.0366	0.0523	820	838	693	1199	978	950	35.2	4960
CXA-T101-U60	630	0.0283	0.043	915	937	790	1383	1124	1093	39.3	6280
CXA-T101-U70	800	0.0221	0.0365	1008	1034	887	1580	1277	1243	44.2	8175
CXA-T101-U80	1000	0.0176	0.0319	1097	1130	994	1796	1448	1412	51.7	10225
1 Core - AL/XLPE/PVC											
AXA-T101-U11	16	1.91	2.4489	100	102	74	109	87	85	11.5	170
AXA-T101-U12	25	1.2	1.5386	129	131	96	144	115	112	12.6	215
AXA-T101-U13	35	0.868	1.113	155	157	115	176	141	137	13.7	255
AXA-T101-U14	50	0.641	0.8221	183	185	137	213	171	166	15	305
AXA-T101-U15	70	0.443	0.5683	224	227	170	269	216	210	16.8	390
AXA-T101-U16	95	0.32	0.4108	267	271	205	328	265	257	18.3	480
AXA-T101-U17	120	0.253	0.3251	304	309	236	381	309	300	19.9	575
AXA-T101-U18	150	0.206	0.265	341	346	267	435	353	343	21.3	675
AXA-T101-U19	185	0.164	0.2115	386	393	306	503	410	398	23.2	805
AXA-T101-U20	240	0.125	0.1619	448	456	361	599	490	475	25.7	1005
AXA-T101-U30	300	0.1	0.1304	507	516	414	695	569	551	28.1	1210
AXA-T101-U40	400	0.0778	0.1026	579	590	478	815	668	648	31	1505
AXA-T101-U50	500	0.0605	0.0812	660	673	557	955	787	763	35.1	1900
AXA-T101-U60	630	0.0469	0.0648	749	765	645	1114	919	892	39.2	2410
AXA-T101-U70	800	0.0367	0.0529	842	863	740	1298	1070	1039	44.6	3080
AXA-T101-U80	1000	0.0291	0.0445	936	961	845	1500	1234	1200	51.7	3830

The above data is approximate and subjected to manufacturing tolerance.

1.8/3 (3.6) KV Single Core ATA Cables

Single Core Cables, With Stranded Copper or Aluminum Conductors, XLPE insulation, Aluminum Tape Armoured, and PVC Sheathed.



Description

- Soft annealed copper or Aluminum conductor, insulated with XLPE compound rated 90 °C, Aluminum Tape Armoured and sheathed with PVC compound layer.
- Cables are produced according to IEC 60502.

Application

- For outdoor and indoor installation in damp and wet locations where mechanical damages are expected to occur.

Product Code	Nominal Cross sectional area	Maximum Conductor Resistance		Current Rating						Approx. Overall Diameter	Approx. Weight
		DC at 20 °C	AC at 90 °C	Laid in ground			Laid in free air (Shaded)				
				Flat	Trefoil	Duct	Flat Separated	Flat Touched	Trefoil Touched		
mm ²	Ω/Km	Ω/Km	A	A	A	A	A	A	mm	Kg/Km	
1 Core - Cu/XLPE/ATA/PVC											
CXA-T101-B12	25	0.727	0.9271	167	169	129	192	159	154	16.4	485
CXA-T101-B13	35	0.524	0.6684	200	203	155	234	193	188	17.5	590
CXA-T101-B14	50	0.387	0.4938	237	240	185	282	233	227	18.8	730
CXA-T101-B15	70	0.268	0.3422	289	294	228	353	292	284	20.4	945
CXA-T101-B16	95	0.193	0.2468	345	351	275	429	356	346	21.9	1210
CXA-T101-B17	120	0.153	0.1961	391	398	314	495	411	400	23.3	1460
CXA-T101-B18	150	0.124	0.1594	438	446	353	562	468	456	24.7	1735
CXA-T101-B19	185	0.0991	0.128	494	504	404	645	539	525	26.4	2090
CXA-T101-B20	240	0.0754	0.0984	570	582	471	760	638	622	29	2660
CXA-T101-B30	300	0.0601	0.0797	640	655	536	871	734	716	31.4	3240
CXA-T101-B40	400	0.047	0.0638	719	739	613	997	846	828	34.6	4120
CXA-T101-B50	500	0.0366	0.0516	805	831	698	1141	975	957	38.6	5230
CXA-T101-B60	630	0.0283	0.0423	892	926	792	1291	1110	1094	42.7	6575
CXA-T101-B70	800	0.0221	0.0356	974	1018	884	1439	1248	1236	48	8545
CXA-T101-B80	1000	0.0176	0.031	1049	1105	981	1592	1396	1390	55.5	10660
1 Core - AL/XLPE/ATA/PVC											
AXA-T101-B11	16	1.91	2.4489	101	102	77	113	94	92	15.3	290
AXA-T101-B12	25	1.2	1.5386	130	131	100	149	123	120	16.4	335
AXA-T101-B13	35	0.868	1.113	155	157	120	181	150	146	17.5	390
AXA-T101-B14	50	0.641	0.822	184	186	144	219	181	176	18.8	450
AXA-T101-B15	70	0.443	0.5683	225	228	177	274	227	221	20.4	540
AXA-T101-B16	95	0.32	0.4107	268	272	213	334	276	269	21.9	635
AXA-T101-B17	120	0.253	0.325	305	310	245	386	320	311	23.3	735
AXA-T101-B18	150	0.206	0.2649	341	347	274	439	364	355	24.7	840
AXA-T101-B19	185	0.164	0.2113	386	393	315	506	421	410	26.4	975
AXA-T101-B20	240	0.125	0.1617	447	456	368	598	500	487	28.9	1190
AXA-T101-B30	300	0.1	0.1301	504	515	422	688	577	562	31.3	1410
AXA-T101-B40	400	0.0778	0.1022	574	588	488	798	675	658	34.6	1760
AXA-T101-B50	500	0.0605	0.0808	652	670	563	925	788	770	38.5	2165
AXA-T101-B60	630	0.0469	0.0643	735	759	648	1064	913	895	42.6	2705
AXA-T101-B70	800	0.0367	0.0523	821	852	743	1214	1052	1035	48.4	3460
AXA-T101-B80	1000	0.0291	0.0438	903	944	838	1371	1200	1186	55.5	4265

The above data is approximate and subjected to manufacturing tolerance.

1.8/3 (3.6) KV Single Core AWA Cables

Single Core Cables, With Stranded Copper or Aluminum Conductors, XLPE insulation, Aluminum Wire Armoured, and PVC Sheathed.



Description

- Soft annealed copper or Aluminum conductor, insulated with XLPE compound rated 90 °C, Aluminum Wire Armoured and sheathed with PVC compound layer.
- Cables are produced according to IEC 60502 or BS 5467.

Application

- For outdoor and indoor installation in damp and wet locations where mechanical damages are expected to occur.

Product Code	Nominal Cross sectional area	Maximum Conductor Resistance		Current Rating						Approx. Overall Diameter	Approx. Weight
		DC at 20 °C	AC at 90 °C	Laid in ground			Laid in free air (Shaded)				
				Flat	Trefoil	Duct	Flat Separated	Flat Touched	Trefoil Touched		
mm ²	Ω/Km	Ω/Km	A	A	A	A	A	A	mm	Kg/Km	
1 Core - Cu/XLPE/AWA/PVC											
CXA-T101-X12	25	0.727	0.9271	169	171	133	197	165	161	18.7	590
CXA-T101-X13	35	0.524	0.6683	202	205	159	239	201	196	19.8	705
CXA-T101-X14	50	0.387	0.4937	238	242	189	287	241	235	21.1	845
CXA-T101-X15	70	0.268	0.3422	289	295	232	356	300	293	22.7	1075
CXA-T101-X16	95	0.193	0.2467	344	351	278	430	363	355	24.2	1350
CXA-T101-X17	120	0.153	0.196	388	397	317	491	417	409	25.6	1610
CXA-T101-X18	150	0.124	0.1593	433	444	357	554	473	464	27	1890
CXA-T101-X19	185	0.0991	0.1279	484	499	404	627	539	530	28.7	2260
CXA-T101-X20	240	0.0754	0.0982	553	573	469	725	631	624	31.3	2845
CXA-T101-X30	300	0.0601	0.0794	613	639	528	813	717	711	33.9	3460
CXA-T101-X40	400	0.047	0.0635	673	710	593	898	809	810	37.2	4375
CXA-T101-X50	500	0.0366	0.0512	738	787	668	997	913	923	41.2	5510
CXA-T101-X60	630	0.0283	0.0418	801	864	745	1097	1019	1038	45.1	6860
CXA-T101-X70	800	0.0221	0.0349	825	905	797	1152	1088	1126	51.6	9055
CXA-T101-X80	1000	0.0176	0.0304	864	958	862	1248	1184	1235	59.1	11245
1 Core - AL/XLPE/AWA/PVC											
AXA-T101-X11	16	1.91	2.4489	102	103	80	117	98	96	17.6	390
AXA-T101-X12	25	1.2	1.5386	131	133	103	153	128	125	18.7	440
AXA-T101-X13	35	0.868	1.113	157	159	123	186	156	152	19.8	500
AXA-T101-X14	50	0.641	0.822	185	188	147	224	187	183	21.1	565
AXA-T101-X15	70	0.443	0.5682	226	230	181	279	234	228	22.7	670
AXA-T101-X16	95	0.32	0.4107	268	273	217	337	283	277	24.2	780
AXA-T101-X17	120	0.253	0.3249	304	311	248	388	327	319	25.6	885
AXA-T101-X18	150	0.206	0.2648	339	347	279	438	371	362	27	1000
AXA-T101-X19	185	0.164	0.2112	383	392	317	500	426	417	28.7	1145
AXA-T101-X20	240	0.125	0.1615	440	452	371	584	501	492	31.2	1375
AXA-T101-X30	300	0.1	0.1299	492	508	420	661	574	565	33.8	1630
AXA-T101-X40	400	0.0778	0.102	551	574	480	749	661	655	37.2	2015
AXA-T101-X50	500	0.0605	0.0805	616	647	550	847	759	757	41.1	2445
AXA-T101-X60	630	0.0469	0.064	683	724	625	951	865	868	45	2990
AXA-T101-X70	800	0.0367	0.0518	725	782	688	1031	955	972	52	3980
AXA-T101-X80	1000	0.0291	0.0432	778	848	763	1136	1061	1089	59.1	4850

The above data is approximate and subjected to manufacturing tolerance.

1.8/3 (3.6) KV Multi Core Unarmoured Cables

Multi Core Cables, with stranded copper or Aluminum conductors, XLPE insulated, copper tape shield and PVC Sheath.



Description

- Soft stranded copper or aluminum conductor, insulated with XLPE compound rated 90 °C assembled together, Shielded with copper tape and sheathed with PVC compound layer.
- Cable are produced according to IEC 60502.

Application

- For outdoor and indoor installation in damp and wet locations. They are normally used for power distribution in urban networks, industrial plants, as well as in the thermopower and hydropower stations.

Product Code	Nominal Cross sectional area mm ²	Maximum Conductor Resistance		Current Rating			Approx. Overall Diameter mm	Approx. Overall Diameter Kg/Km
		DC at 20 °C Ω/Km	AC at 90 °C Ω/Km	Laid in ground A	Laid in duct A	Laid in free air (Shaded) A		
3 core cables - Cu/XLPE/PVC								
CXA-T103-Z12	25 RM	0.727	0.9272	149	113	130	26.9	1200
CXA-T103-Z13	35 RM	0.524	0.6685	179	136	159	29.4	1525
CXA-T103-Z14	50 SM	0.387	0.4939	213	160	190	29.4	1875
CXA-T103-Z15	70 SM	0.268	0.3423	262	198	238	32.5	2545
CXA-T103-Z16	95 SM	0.193	0.247	315	240	291	35.8	3355
CXA-T103-Z17	120 SM	0.153	0.1962	356	274	333	38.2	4100
CXA-T103-Z18	150 SM	0.124	0.1596	401	311	380	41.3	4930
CXA-T103-Z19	185 SM	0.0991	0.1282	453	354	437	44.5	6045
CXA-T103-Z20	240 SM	0.0754	0.0987	525	414	516	49.4	7795
CXA-T103-Z30	300 SM	0.0601	0.0799	594	473	592	53.7	9595
CXA-T103-Z40	400 SM	0.047	0.0641	675	545	688	60.3	12220
CXA-T103-Z50	500 SM	0.0366	0.0518	760	622	788	67.2	15615
3 core cables - AL/XLPE/PVC								
AXA-T103-Z11	16 RM	1.91	2.4489	89	67	77	24.5	615
AXA-T103-Z12	25 RM	1.2	1.5387	115	88	101	26.9	750
AXA-T103-Z13	35 RM	0.868	1.1131	138	105	123	29.4	910
AXA-T103-Z14	50 SM	0.641	0.8221	165	124	147	29.4	1030
AXA-T103-Z15	70 SM	0.443	0.5683	203	154	184	32.5	1300
AXA-T103-Z16	95 SM	0.32	0.4108	244	186	226	35.8	1605
AXA-T103-Z17	120 SM	0.253	0.3251	276	213	259	38.2	1910
AXA-T103-Z18	150 SM	0.206	0.265	311	241	295	41.3	2260
AXA-T103-Z19	185 SM	0.164	0.2114	353	276	340	44.5	2640
AXA-T103-Z20	240 SM	0.125	0.1618	411	323	403	49.4	3345
AXA-T103-Z30	300 SM	0.1	0.1302	465	371	464	53.7	3960
AXA-T103-Z40	400 SM	0.0778	0.1023	535	432	545	60.3	5080
AXA-T103-Z50	500 SM	0.0605	0.0809	609	498	632	67.2	6375

The above data is approximate and subjected to manufacturing tolerance.

rm: Round, Stranded
sm: Sector, Stranded

1.8/3 (3.6) KV Multi Core STA Cables

Multi Core Cables, with stranded copper or Aluminum conductors, XLPE insulated, Steel tape Armoured and PVC Sheath.



Description

- Soft stranded copper or aluminum conductor, insulated with XLPE compound rated 90 °C assembled together, Armoured with Steel tape and sheathed with PVC compound layer.
- Cable are produced according to IEC 60502.

Application

- For outdoor and indoor installation in damp and wet locations Where mechanical damage are expected to occur.

Product Code	Nominal Cross sectional area mm ²	Maximum Conductor Resistance		Current Rating			Approx. Overall Diameter mm	Approx. Overall Diameter Kg/Km
		DC at 20 °C Ω/Km	AC at 90 °C Ω/Km	Laid in ground A	Laid in duct A	Laid in free air (Shaded) A		
3 core cables - Cu/XLPE/STA/PVC								
CXA-T103-G12	25 RM	0.727	0.9272	149	113	131	27.1	1295
CXA-T103-G13	35 RM	0.524	0.6685	179	136	160	29.6	1635
CXA-T103-G14	50 SM	0.387	0.4939	227	167	204	29.4	1930
CXA-T103-G15	70 SM	0.268	0.3423	279	206	256	32.5	2600
CXA-T103-G16	95 SM	0.193	0.247	338	254	319	37	3755
CXA-T103-G17	120 SM	0.153	0.1962	383	287	365	39.2	4510
CXA-T103-G18	150 SM	0.124	0.1596	431	326	419	42.3	5370
CXA-T103-G19	185 SM	0.0991	0.1282	487	372	482	45.7	6530
CXA-T103-G20	240 SM	0.0754	0.0987	565	437	572	50.4	8305
CXA-T103-G30	300 SM	0.0601	0.0799	639	497	660	54.7	10150
CXA-T103-G40	400 SM	0.047	0.0641	728	573	772	61.1	12810
CXA-T103-G50	500 SM	0.0366	0.0518	820	654	889	67.8	16245
3 core cables - AL/XLPE/STA/PVC								
AXA-T103-G11	16 RM	1.91	2.4489	90	68	77	24.7	690
AXA-T103-G12	25 RM	1.2	1.5387	116	88	102	27.1	845
AXA-T103-G13	35 RM	0.868	1.1131	139	105	124	29.6	1020
AXA-T103-G14	50 SM	0.641	0.8221	176	129	158	29.4	1090
AXA-T103-G15	70 SM	0.443	0.5683	217	160	199	32.5	1355
AXA-T103-G16	95 SM	0.32	0.4108	262	197	247	37	2005
AXA-T103-G17	120 SM	0.253	0.3251	297	223	284	39.2	2320
AXA-T103-G18	150 SM	0.206	0.265	335	253	325	42.3	2700
AXA-T103-G19	185 SM	0.164	0.2114	380	290	376	45.7	3130
AXA-T103-G20	240 SM	0.125	0.1618	443	342	448	50.4	3850
AXA-T103-G30	300 SM	0.1	0.1302	502	390	518	54.7	4515
AXA-T103-G40	400 SM	0.0778	0.1023	578	455	613	61.1	5670
AXA-T103-G50	500 SM	0.0605	0.0809	659	526	715	67.8	7005

The above data is approximate and subjected to manufacturing tolerance.

rm: Round, Stranded
sm: Sector, Stranded

1.8/3 (3.6) KV Multi Core SWA Cables

Multi Core Cables, with stranded copper or Aluminum conductors, XLPE insulated, Steel wire Armoured and PVC Sheath.



Description

- Soft stranded copper or aluminum conductor, insulated with XLPE compound rated 90 °C assembled together, Armoured with Steel wire and sheathed with PVC compound layer.
- Cable are produced according to IEC 60502, BS 5467.

Application

- For outdoor and indoor installation in damp and wet locations Where mechanical damage are expected to occur.

Product Code	Nominal Cross sectional area mm ²	Maximum Conductor Resistance		Current Rating			Approx. Overall Diameter mm	Approx. Overall Diameter Kg/Km
		DC at 20 °C Ω/Km	AC at 90 °C Ω/Km	Laid in ground A	Laid in duct A	Laid in free air (Shaded) A		
3 core cables - Cu/XLPE/SWA/PVC								
CXA-T103-W12	25 RM	0.727	0.9272	150	116	134	30.6	1930
CXA-T103-W13	35 RM	0.524	0.6685	180	139	163	32.9	2310
CXA-T103-W14	50 SM	0.387	0.4939	231	171	212	33.3	2770
CXA-T103-W15	70 SM	0.268	0.3423	283	212	265	36.4	3555
CXA-T103-W16	95 SM	0.193	0.247	341	256	326	39.5	4440
CXA-T103-W17	120 SM	0.153	0.1962	385	292	375	42.9	5655
CXA-T103-W18	150 SM	0.124	0.1596	433	331	428	46	6590
CXA-T103-W19	185 SM	0.0991	0.1282	488	376	491	49.4	7830
CXA-T103-W20	240 SM	0.0754	0.0987	565	440	580	53.9	9710
CXA-T103-W30	300 SM	0.0601	0.0799	633	496	663	58.4	11720
CXA-T103-W40	400 SM	0.047	0.0641	715	567	769	64.8	14570
CXA-T103-W50	500 SM	0.0366	0.0518	791	635	872	73	19020
3 core cables - AL/XLPE/SWA/PVC								
AXA-T103-W11	16 RM	1.91	2.4489	90	69	80	28	1245
AXA-T103-W12	25 RM	1.2	1.5387	117	90	104	30.6	1485
AXA-T103-W13	35 RM	0.868	1.1131	140	108	127	32.9	1695
AXA-T103-W14	50 SM	0.641	0.8221	179	133	164	33.3	1925
AXA-T103-W15	70 SM	0.443	0.5683	220	164	206	36.4	2310
AXA-T103-W16	95 SM	0.32	0.4108	265	199	253	39.5	2690
AXA-T103-W17	120 SM	0.253	0.3251	300	228	292	42.9	3465
AXA-T103-W18	150 SM	0.206	0.265	337	258	334	46	3920
AXA-T103-W19	185 SM	0.164	0.2114	382	294	384	49.4	4430
AXA-T103-W20	240 SM	0.125	0.1618	444	346	456	53.9	5255
AXA-T103-W30	300 SM	0.1	0.1302	501	393	524	58.4	6085
AXA-T103-W40	400 SM	0.0778	0.1023	573	454	616	64.8	7430
AXA-T103-W50	500 SM	0.0605	0.0809	646	518	711	73	9780

The above data is approximate and subjected to manufacturing tolerance.

rm: Round, Stranded
sm: Sector, Stranded





Medium Voltage Cables

**Operating Voltage
(up to 18/30 kV)**

Cable Construction

1. Conductor

Stranded, round and compacted Copper or Aluminium conductors, according to IEC 60228 - class 2.

2. Conductor Screen

An extruded layer of semi conducting material applied over the conductor as voltage stress control layer.

3. Insulation

An extruded layer of cross linked polyethylene (XLPE) is applied over the inner semi conductor with thickness as specified in IEC 60502.

4. Insulation Screen

An extruded layer of strippable or firmly bonded to the insulation. Conductor screen, XLPE insulation and insulation screen are applied at the same time using triple head extruder.

5. Metallic Screen

- Copper Tape: an annealed Copper tape is applied helically with a suitable overlap.
- Copper Wire: helically applied and binded with a Copper tape to achieve electrical contact

6. Assembly

In case of three core cables, cores are assembled together with suitable lay length, non-hygroscopic filler is applied during assembly to fill spaces between cores then wrapped with suitable binder tape.

7. Bedding

In case of armoured cables an extruded layer of PVC or PE is applied as bedding.

8. Armouring

- Steel Tape: double layers of steel tapes are applied helically.
- Steel Wire: galvanized steel wires are applied helically.

9. Sheath

An extruded layer of PVC is applied with thickness as specified in IEC 60502.

Option

Lead Sheath: Upon request a layer of lead is extruded over the bedding layer.

Armouring of Single Core Cable

- Armouring by non-magnetic material either Aluminium Tape or Aluminium Wire armouring to reduce the magnetic losses.
- If it is required for single core cable to be armoured by steel wire armouring, the magnetic circuit around the single core cable should be interrupted by inserting insulated copper wires between the steel wires.

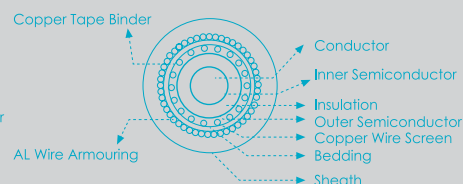
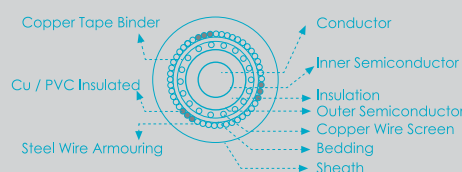

3.6/6 (7.2) KV Single core Unarmoured Cables

Single Core Cables, with stranded Circular copper or Aluminum conductors, XLPE insulated, and PVC Sheath.



Description

- Stranded circular compacted copper or aluminum conductor, Semi-conducting layer as conductor screen, XLPE insulated, semi-conducting layer as non metallic insulation screen, copper tape or wire as metallic insulation screen, and PVC sheathed.
- Cables are produced according to IEC 60502.

Application

- These cables are generally suitable for direct burial or for installation on trays or in ducts.

Product Code	Nominal Cross sectional area	Max. Conductor Resistance		Capacitance	Inductance		Current Rating					Approx. Overall Diameter	Approx. Weight
		DC at 20 °C	AC at 90 °C		Trefoil	Flat	Laid in ground			Laid in free air (Shaded)			
							Flat	Trefoil	Duct	Flat Touched	Trefoil Touched		
		mm ²	Ω/Km		Ω/Km	µf/km	mh/km	A	A	A	A		
1 Core - Cu/XLPE/PVC													
CXB-T101-U12	25	0.727	0.9271	0.2520	0.4033	0.5733	168	172	124	151	155	15.8	450
CXB-T101-U13	35	0.524	0.6684	0.2832	0.3820	0.5538	201	207	149	184	189	16.9	555
CXB-T101-U14	50	0.387	0.4938	0.3200	0.3557	0.5362	238	245	179	223	229	18.4	700
CXB-T101-U15	70	0.268	0.3422	0.3735	0.3336	0.5126	292	292	228	282	290	20.3	925
CXB-T101-U16	95	0.193	0.2468	0.4072	0.3245	0.4901	348	347	270	343	350	21.7	1185
CXB-T101-U17	120	0.153	0.1961	0.4464	0.3137	0.4668	395	394	310	395	405	23.1	1435
CXB-T101-U18	150	0.124	0.1594	0.4856	0.3062	0.4714	443	441	351	451	462	24.7	1715
CXB-T101-U19	185	0.0991	0.1280	0.5331	0.2941	0.4769	501	498	400	520	532	26.4	2085
CXB-T101-U20	240	0.0754	0.0984	0.6001	0.2846	0.4666	580	575	468	618	630	29	2660
CXB-T101-U30	300	0.0601	0.0796	0.6492	0.2781	0.4616	654	646	546	714	726	32	3265
CXB-T101-U40	400	0.047	0.0637	0.6722	0.2734	0.4571	742	727	619	827	838	35.2	4125
CXB-T101-U50	500	0.0366	0.0515	0.7107	0.2676	0.4513	837	815	709	960	965	39.2	5280
CXB-T101-U60	630	0.0283	0.0422	0.7908	0.2612	0.4452	934	904	804	1099	1098	42.9	6620
CXB-T101-U70	800	0.0221	0.0356	0.8917	0.2558	0.4401	1032	988	902	1246	1232	47.8	8505
1 Core - AL/XLPE/PVC													
AXB-T101-U12	25	1.2	1.5386	0.2520	0.4033	0.4495	130	133	97	118	121	15.8	300
AXB-T101-U13	35	0.868	1.1130	0.2832	0.3820	0.4282	156	160	118	144	152	16.9	350
AXB-T101-U14	50	0.641	0.8220	0.3200	0.3557	0.4019	185	190	142	174	182	18.4	415
AXB-T101-U15	70	0.443	0.5683	0.3651	0.3367	0.3829	222	230	175	223	229	20	505
AXB-T101-U16	95	0.32	0.4107	0.4072	0.3245	0.3708	269	278	210	270	274	21.7	610
AXB-T101-U17	120	0.253	0.3250	0.4464	0.3137	0.3599	309	317	243	310	320	23.1	705
AXB-T101-U18	150	0.206	0.2649	0.4856	0.3062	0.3524	340	348	274	352	360	24.7	825
AXB-T101-U19	185	0.164	0.2113	0.5331	0.2941	0.3403	390	393	312	410	420	26.4	955
AXB-T101-U20	240	0.125	0.1617	0.5973	0.2850	0.3312	452	454	375	484	495	28.9	1170
AXB-T101-U30	300	0.1	0.1300	0.6412	0.2786	0.3248	513	509	423	560	571	31.7	1415
AXB-T101-U40	400	0.0778	0.1021	0.6672	0.2723	0.3185	587	577	490	655	665	35	1750
AXB-T101-U50	500	0.0605	0.0807	0.7084	0.2688	0.3151	671	660	570	769	779	39.3	2190
AXB-T101-U60	630	0.0469	0.0642	0.7896	0.2620	0.3083	762	770	655	895	900	43	2700
AXB-T101-U70	800	0.0367	0.0523	0.9010	0.2552	0.3014	858	885	749	1032	1032	48.2	3400

The above data is approximate and subjected to manufacturing tolerance
this data is applicable also for 3.8/6.6 KV

3.6/6 (7.2) KV Multi Core Unarmoured Cables

Three Core Cables, with stranded circular copper or Aluminum conductors, XLPE insulated, and PVC Sheath.



Description

- Stranded circular compacted copper or aluminum conductor, Semi-conducting layer as conductor screen, XLPE insulated, semi-conducting layer as non metallic insulation screen, copper tape or wire as metallic insulation screen, cores are assembled together with non hygroscopic polypropylene fillers and wrapped with binder tape, and PVC sheathed.
- Cables are produced according to IEC 60502.

Application

- These cables are generally suitable for direct burial or for installation on trays or in ducts.

Product Code	Nominal Cross sectional area	Max. Conductor Resistance		Capacitance	Inductance	Current Rating			Approx. Overall Diameter	Approx. Weight
		DC at 20 °C	AC at 90 °C			Ground	Duct	Laid in free air (Shaded)		
		Ω/Km	Ω/Km							
	mm ²			µf/km	mh/km	A	A	A	mm	Kg/Km
3 Core - Cu/XLPE/PVC										
CXB-T103-U12	25	0.727	0.9272	0.2520	0.3746	167	123	151	32.8	1475
CXB-T103-U13	35	0.524	0.6684	0.2832	0.3555	197	146	179	35.2	1805
CXB-T103-U14	50	0.387	0.4938	0.3200	0.3291	233	175	217	38.2	2265
CXB-T103-U15	70	0.268	0.3423	0.3735	0.3100	286	216	271	42.7	3020
CXB-T103-U16	95	0.193	0.2470	0.4072	0.3007	342	260	331	45.5	3825
CXB-T103-U17	120	0.153	0.1963	0.4464	0.2916	390	296	383	48.7	4630
CXB-T103-U18	150	0.124	0.1596	0.4856	0.2840	438	337	437	51.9	5500
CXB-T103-U19	185	0.0991	0.1283	0.5331	0.2736	495	384	503	55.8	6685
CXB-T103-U20	240	0.0754	0.0989	0.6001	0.2649	574	450	596	61.4	8515
CXB-T103-U30	300	0.0601	0.0801	0.6492	0.2593	655	519	703	67.8	10445
CXB-T103-U40	400	0.047	0.0644	0.6722	0.2556	731	587	792	74.7	13175
CXB-T103-U50	500	0.0366	0.0523	0.7107	0.2510	824	670	914	83.5	16885
3 Core - AL/XLPE/PVC										
AXB-T103-U12	25	1.2	1.5386	0.2520	0.3746	129	96	118	32.8	1025
AXB-T103-U13	35	0.868	1.1130	0.2832	0.3555	155	115	143	35.2	1190
AXB-T103-U14	50	0.641	0.8220	0.3200	0.3291	184	137	173	38.2	1410
AXB-T103-U15	70	0.443	0.5683	0.3651	0.3127	225	170	217	42.1	1745
AXB-T103-U16	95	0.32	0.4108	0.4072	0.3007	269	204	264	45.5	2095
AXB-T103-U17	120	0.253	0.3251	0.4464	0.2916	307	235	306	48.7	2440
AXB-T103-U18	150	0.206	0.2650	0.4856	0.2840	344	265	348	51.9	2820
AXB-T103-U19	185	0.164	0.2115	0.5331	0.2736	391	303	402	55.8	3295
AXB-T103-U20	240	0.125	0.1619	0.5973	0.2652	449	352	466	61.2	4035
AXB-T103-U30	300	0.1	0.1304	0.6412	0.2596	508	403	539	67.2	4880
AXB-T103-U40	400	0.0778	0.1026	0.6672	0.2543	582	467	631	74.3	6045
AXB-T103-U50	500	0.0605	0.0812	0.7084	0.2523	673	547	753	83.7	7610

The above data is approximate and subjected to manufacturing tolerance
 this data is applicable also for 3.8/6.6 KV

3.6/6 (7.2) KV Single Core ATA Cables

Single Core Cables, with stranded Circular copper or Aluminum conductors, XLPE insulated, Aluminum tape armored, and PVC sheath



Description

- Stranded circular compacted copper or aluminum conductor, Semi-conducting layer as conductor screen, XLPE insulated, semi-conducting layer as non metallic insulation screen, copper tape or wire as metallic insulation screen, covered with a layer of PVC compound as bedding layer, aluminum tape armored and PVC sheath.
- Cables are produced according to IEC 60502.

Application

- These cables are generally suitable for direct burial or for installation on trays or in ducts.

Product Code	Nominal Cross sectional area	Max. Conductor Resistance		Capacitance	Inductance		Current Rating					Approx. Overall Diameter	Approx. Weight
		DC at 20 °C	AC at 90 °C		Trefoil	Flat	Laid in ground			Laid in free air (Shaded)			
							Flat	Trefoil	Duct	Flat Touched	Trefoil Touched		
		mm ²	Ω/Km		Ω/Km	μf/km	mh/km	A	A	A	A		
1 Core - Cu/XLPE/ATA/PVC													
CXB-T101-B12	25	0.727	0.9271	0.2520	0.4504	0.4966	468	160	132	160	163	20	645
CXB-T101-B13	35	0.524	0.6683	0.2832	0.4283	0.4745	203	207	159	194	199	21.3	775
CXB-T101-B14	50	0.387	0.4937	0.3200	0.3968	0.4430	238	238	189	235	239	22.6	925
CXB-T101-B15	70	0.268	0.3421	0.3735	0.3713	0.4175	292	291	233	234	298	24.5	1175
CXB-T101-B16	95	0.193	0.2467	0.4072	0.3584	0.4046	349	347	279	292	362	25.7	1435
CXB-T101-B17	120	0.153	0.1959	0.4464	0.3471	0.3933	397	394	319	364	417	27.3	1715
CXB-T101-B18	150	0.124	0.1592	0.4856	0.3362	0.3824	444	440	360	409	473	28.7	1995
CXB-T101-B19	185	0.0991	0.1278	0.5331	0.3236	0.3698	502	495	410	465	542	30.6	2400
CXB-T101-B20	240	0.0754	0.0981	0.6001	0.3117	0.3579	580	569	479	632	637	33.2	3005
CXB-T101-B30	300	0.0601	0.0792	0.6492	0.3028	0.3490	654	637	546	727	729	36.2	3640
CXB-T101-B40	400	0.047	0.0632	0.6722	0.2949	0.3412	740	714	623	839	835	39.2	4515
CXB-T101-B50	500	0.0366	0.0509	0.7107	0.2879	0.3342	833	794	712	968	953	43.4	5735
CXB-T101-B60	630	0.0283	0.0415	0.7908	0.2808	0.3270	931	874	804	1106	1073	47.3	7135
CXB-T101-B70	800	0.0221	0.0348	0.8917	0.2727	0.3189	1025	947	896	1249	1192	52	9050
1 Core - AL/XLPE/ATA/PVC													
AXB-T101-B12	25	1.2	1.5386	0.2520	0.4504	0.4966	131	131	103	124	127	20	495
AXB-T101-B13	35	0.868	1.1130	0.2832	0.4283	0.4745	157	156	123	151	154	21.3	570
AXB-T101-B14	50	0.641	0.8220	0.3200	0.3968	0.4430	185	185	147	181	186	22.6	640
AXB-T101-B15	70	0.443	0.5682	0.3651	0.3748	0.4210	227	226	185	226	232	24.2	745
AXB-T101-B16	95	0.32	0.4106	0.4072	0.3584	0.4046	271	270	217	275	282	25.7	860
AXB-T101-B17	120	0.253	0.3249	0.4464	0.3471	0.3933	309	307	248	318	325	27.3	985
AXB-T101-B18	150	0.206	0.2648	0.4856	0.3362	0.3824	345	343	280	361	369	28.7	1105
AXB-T101-B19	185	0.164	0.2111	0.5331	0.3236	0.3698	391	388	320	417	425	30.6	1270
AXB-T101-B20	240	0.125	0.1614	0.5973	0.3122	0.3584	453	449	374	493	502	33.1	1510
AXB-T101-B30	300	0.1	0.1298	0.6412	0.3035	0.3497	513	505	427	569	576	35.9	1785
AXB-T101-B40	400	0.0778	0.1018	0.6672	0.2939	0.3401	586	574	494	665	670	39	2140
AXB-T101-B50	500	0.0605	0.0803	0.7084	0.2892	0.3354	669	648	571	777	776	43.5	2645
AXB-T101-B60	630	0.0469	0.0637	0.7896	0.2815	0.3277	759	727	679	901	891	47.4	3220
AXB-T101-B70	800	0.0367	0.0517	0.9010	0.2719	0.3181	853	807	747	1041	1016	52.4	3950

The above data is approximate and subjected to manufacturing tolerance
this data is applicable also for 3.8/6.6 KV

3.6/6 (7.2) KV Multi Core STA Cables

Three Core Cables, with stranded circular copper or Aluminum conductors, XLPE insulated, Steel tape armoured and PVC Sheath.



Description

- Stranded circular compacted copper or aluminum conductor, Semi-conducting layer as conductor screen, XLPE insulated, semi-conducting layer as non metallic insulation screen, copper tape or wire as metallic insulation screen, cores are assembled together with non hygroscopic polypropylene fillers and wrapped with binder tape, covered with a layer of PVC compound as bedding, steel tape armoured and PVC sheathed.
- Cables are produced according to IEC 60502.

Application

- These cables are generally suitable for direct burial or for installation on trays or in ducts.

Product Code	Nominal Cross sectional area mm ²	Max. Conductor Resistance		Capacitance µf/km	Inductance mh/km	Current Rating			Approx. Overall Diameter mm	Approx. Weight Kg/Km
		DC at 20 °C Ω/Km	AC at 90 °C Ω/Km			Ground A	Duct A	Laid in free air (Shaded) A		
3 Core - Cu/XLPE/STA/PVC										
CXB-T103-G12	25	0.727	0.9272	0.2520	0.3746	157	122	146	37.2	2220
CXB-T103-G13	35	0.524	0.6684	0.2832	0.3555	188	146	177	39.8	2625
CXB-T103-G14	50	0.387	0.4938	0.3200	0.3291	223	174	212	42.8	3150
CXB-T103-G15	70	0.268	0.3423	0.3735	0.3100	273	216	265	47.3	4005
CXB-T103-G16	95	0.193	0.2470	0.4072	0.3007	325	258	319	50.1	4870
CXB-T103-G17	120	0.153	0.1963	0.4464	0.2916	368	294	365	53.5	5775
CXB-T103-G18	150	0.124	0.1596	0.4856	0.2840	412	331	414	56.7	6715
CXB-T103-G19	185	0.0991	0.1283	0.5331	0.2736	465	375	473	60.6	7990
CXB-T103-G20	240	0.0754	0.0989	0.6001	0.2649	535	433	553	66.4	9980
CXB-T103-G30	300	0.0601	0.0801	0.6492	0.2593	599	490	630	72.8	12060
CXB-T103-G40	400	0.047	0.0644	0.6722	0.2556	674	560	721	81.5	15820
CXB-T103-G50	500	0.0366	0.0523	0.7107	0.2510	754	634	822	90.1	19790
3 Core - AL/XLPE/STA/PVC										
AXB-T103-G12	25	1.2	1.5386	0.2520	0.3746	122	95	113	37.2	1770
AXB-T103-G13	35	0.868	1.1130	0.2832	0.3555	146	113	137	39.8	2010
AXB-T103-G14	50	0.641	0.8220	0.3200	0.3291	173	135	165	42.8	2295
AXB-T103-G15	70	0.443	0.5683	0.3651	0.3127	212	167	205	46.7	2720
AXB-T103-G16	95	0.32	0.4108	0.4072	0.3007	253	201	248	50.1	3140
AXB-T103-G17	120	0.253	0.3251	0.4464	0.2916	287	229	285	53.5	3585
AXB-T103-G18	150	0.206	0.2650	0.4856	0.2840	322	258	323	56.7	4040
AXB-T103-G19	185	0.164	0.2115	0.5331	0.2736	365	294	371	60.6	4600
AXB-T103-G20	240	0.125	0.1619	0.5973	0.2652	421	342	435	66.2	5495
AXB-T103-G30	300	0.1	0.1304	0.6412	0.2596	475	389	498	72.2	6485
AXB-T103-G40	400	0.0778	0.1026	0.6672	0.2543	541	450	578	81.1	8680
AXB-T103-G50	500	0.0605	0.0812	0.7084	0.2523	615	518	670	90.3	10525

The above data is approximate and subjected to manufacturing tolerance
this data is applicable also for 3.8/6.6 KV

3.6/6 (7.2) KV Single Core AWA Cables

Single Core Cables, with stranded Circular copper or Aluminum conductors, XLPE insulated, aluminum wire armoured and PVC Sheath.



Description

- Stranded circular compacted copper or aluminum conductor, Semi-conducting layer as conductor screen, XLPE insulated, semi-conducting layer as non metallic insulation screen, copper tape or wire as metallic insulation screen, covered with a layer of PVC compound as bedding layer, aluminum wire armoured and PVC sheath.
- Cables are produced according to IEC 60502 or BS 6622.

Application

- These cables are generally suitable for direct burial or for installation on trays or in ducts.

Product Code	Nominal Cross sectional area	Max. Conductor Resistance		Capacitance	Inductance		Current Rating					Approx. Overall Diameter	Approx. Weight
		DC at 20 °C	AC at 90 °C		Trefoil	Flat	Laid in ground			Laid in free air (Shaded)			
							Flat	Trefoil	Duct	Flat Touched	Trefoil Touched		
		mm ²	Ω/Km		Ω/Km	µf/km	mh/km	A	A	A	A		
1 Core - Cu/XLPE/AWA/PVC													
CXB-T101-X12	25	0.727	0.9271	0.2520	0.4704	0.5166	169	169	134	163	166	22.1	765
CXB-T101-X13	35	0.524	0.6683	0.2832	0.4454	0.4916	202	202	161	198	202	23.2	885
CXB-T101-X14	50	0.387	0.4937	0.3200	0.4129	0.4592	239	238	191	238	242	24.5	1045
CXB-T101-X15	70	0.268	0.3421	0.3735	0.3862	0.4324	292	290	235	295	299	26.4	1300
CXB-T101-X16	95	0.193	0.2467	0.4072	0.3741	0.4203	348	344	281	357	360	27.8	1580
CXB-T101-X17	120	0.153	0.1959	0.4464	0.3605	0.4068	392	389	319	410	411	29.2	1860
CXB-T101-X18	150	0.124	0.1591	0.4856	0.3503	0.3965	438	433	359	465	463	30.8	2160
CXB-T101-X19	185	0.0991	0.1277	0.5331	0.3399	0.3862	491	482	405	532	523	33.2	2620
CXB-T101-X20	240	0.0754	0.0979	0.6001	0.3256	0.3718	562	544	468	622	604	35.6	3230
CXB-T101-X30	300	0.0601	0.0790	0.6492	0.3156	0.3618	628	598	527	709	679	38.6	3885
CXB-T101-X40	400	0.047	0.0630	0.6722	0.3078	0.3540	702	656	595	808	762	41.8	4795
CXB-T101-X50	500	0.0366	0.0505	0.7107	0.3039	0.3501	763	689	658	909	830	47	6195
CXB-T101-X60	630	0.0283	0.0410	0.7908	0.2954	0.3417	836	741	729	1019	911	50.9	7635
CXB-T101-X70	800	0.0221	0.0343	0.8917	0.2861	0.3323	904	786	798	1130	991	55.6	9595
1 Core - AL/XLPE/AWA/PVC													
AXB-T101-X12	25	1.2	1.5386	0.2520	0.4704	0.5166	132	132	104	127	130	22.1	615
AXB-T101-X13	35	0.868	1.1130	0.2832	0.4454	0.4916	157	157	125	154	157	23.2	680
AXB-T101-X14	50	0.641	0.8220	0.3200	0.4129	0.4592	186	186	149	185	188	24.5	760
AXB-T101-X15	70	0.443	0.5682	0.3651	0.3899	0.4362	228	227	183	230	234	26.1	875
AXB-T101-X16	95	0.32	0.4106	0.4072	0.3741	0.4203	271	269	219	279	283	27.8	1005
AXB-T101-X17	120	0.253	0.3248	0.4464	0.3605	0.4068	307	306	250	321	325	29.2	1130
AXB-T101-X18	150	0.206	0.2647	0.4856	0.3503	0.3965	343	341	281	364	367	30.8	1270
AXB-T101-X19	185	0.164	0.2110	0.5331	0.3399	0.3862	387	383	320	419	419	33.2	1490
AXB-T101-X20	240	0.125	0.1614	0.5973	0.3262	0.3724	446	440	371	493	488	35.5	1740
AXB-T101-X30	300	0.1	0.1297	0.6412	0.3164	0.3627	502	491	421	564	554	38.3	2025
AXB-T101-X40	400	0.0778	0.1017	0.6672	0.3068	0.3530	567	548	482	653	633	41.6	2415
AXB-T101-X50	500	0.0605	0.0800	0.7084	0.3051	0.3513	632	594	546	750	710	47.1	3105
AXB-T101-X60	630	0.0469	0.0634	0.7896	0.2962	0.3424	706	650	616	856	795	51	3715
AXB-T101-X70	800	0.0367	0.0514	0.9010	0.2852	0.3314	781	704	689	973	886	56	4505

The above data is approximate and subjected to manufacturing tolerance
this data is applicable also for 3.8/6.6 KV

3.6/6 (7.2) KV Multi Core SWA Cables

Three Core Cables, with stranded circular copper or Aluminum conductors, XLPE insulated, Steel wire armoured and PVC Sheath.



Description

- Stranded circular compacted copper or aluminum conductor, Semi-conducting layer as conductor screen, XLPE insulated, semi-conducting layer as non metallic insulation screen, copper tape or wire as metallic insulation screen, cores are assembled together with non hygroscopic polypropylene fillers and wrapped with binder tape, covered with a layer of PVC compound as bedding, steel wire armoured and PVC sheathed.
- Cables are produced according to IEC 60502 or BS 6622.

Application

- These cables are generally suitable for direct burial or for installation on trays or in ducts.

Product Code	Nominal Cross sectional area	Max. Conductor Resistance		Capacitance	Inductance	Current Rating			Approx. Overall Diameter	Approx. Weight
		DC at 20 °C	AC at 90 °C			Ground	Duct	Laid in free air (Shaded)		
		mm ²	Ω/Km							
3 Core - Cu/XLPE/SWA/PVC										
CXB-T103-W12	25	0.727	0.9272	0.2520	0.3746	159	123	149	39.7	2935
CXB-T103-W13	35	0.524	0.6684	0.2832	0.3555	190	149	180	43	3825
CXB-T103-W14	50	0.387	0.4938	0.3200	0.3291	225	177	216	46	4435
CXB-T103-W15	70	0.268	0.3423	0.3735	0.3100	275	219	269	50.5	5430
CXB-T103-W16	95	0.193	0.2470	0.4072	0.3007	327	260	324	53.3	6380
CXB-T103-W17	120	0.153	0.1963	0.4464	0.2916	370	298	370	56.7	7360
CXB-T103-W18	150	0.124	0.1596	0.4856	0.2840	414	333	419	59.9	8420
CXB-T103-W19	185	0.0991	0.1283	0.5331	0.2736	467	378	478	63.8	9810
CXB-T103-W20	240	0.0754	0.0989	0.6001	0.2649	535	438	561	71.3	12720
CXB-T103-W30	300	0.0601	0.0801	0.6492	0.2593	596	493	635	77.9	15130
CXB-T103-W40	400	0.047	0.0644	0.6722	0.2556	663	553	717	85.2	18395
CXB-T103-W50	500	0.0366	0.0523	0.7107	0.2510	734	620	808	94	22720
3 Core - AL/XLPE/SWA/PVC										
AXB-T103-W12	25	1.2	1.5386	0.2520	0.3746	123	96	115	39.7	2485
AXB-T103-W13	35	0.868	1.1130	0.2832	0.3555	147	115	140	43	3210
AXB-T103-W14	50	0.641	0.8220	0.3200	0.3291	174	137	168	46	3580
AXB-T103-W15	70	0.443	0.5683	0.3651	0.3127	213	169	208	49.9	4110
AXB-T103-W16	95	0.32	0.4108	0.4072	0.3007	255	202	252	53.3	4650
AXB-T103-W17	120	0.253	0.3251	0.4464	0.2916	289	232	289	56.7	5170
AXB-T103-W18	150	0.206	0.2650	0.4856	0.2840	323	260	327	59.9	5745
AXB-T103-W19	185	0.164	0.2115	0.5331	0.2736	366	297	375	63.8	6420
AXB-T103-W20	240	0.125	0.1619	0.5973	0.2652	423	347	443	71.1	8240
AXB-T103-W30	300	0.1	0.1304	0.6412	0.2596	475	393	504	77.3	9500
AXB-T103-W40	400	0.0778	0.1026	0.6672	0.2543	537	448	578	84.8	11265
AXB-T103-W50	500	0.0605	0.0812	0.7084	0.2523	605	511	665	94.2	13450

The above data is approximate and subjected to manufacturing tolerance
this data is applicable also for 3.8/6.6 KV

6/10 (12) KV Single Core Unarmoured Cables

Single Core Cables, with stranded circular copper or Aluminum conductors, XLPE insulated, and PVC Sheath.



Description

- Stranded circular compacted copper or aluminum conductor, Semi-conducting layer as conductor screen, XLPE insulated, semi-conducting layer as non metallic insulation screen, copper tape or wire as metallic insulation screen, and PVC sheathed.
- Cables are produced according to IEC 60502.

Application

- These cables are generally suitable for direct burial or for installation on trays or in ducts.

Product Code	Nominal Cross sectional area	Max. Conductor Resistance		Capacitance	Inductance		Current Rating					Approx. Overall Diameter	Approx. Weight
		DC at 20 °C	AC at 90 °C		Trefoil	Flat	Laid in ground			Laid in free air (Shaded)			
							Flat	Trefoil	Duct	Flat Touched	Trefoil Touched		
		mm ²	Ω/Km		Ω/Km	μf/km	mh/km	A	A	A	A		
1 Core - Cu/XLPE/PVC													
CX2-T101-U12	25	0.727	0.9271	0.2094	0.4226	0.4688	168	172	127	155	159	17.4	500
CX2-T101-U13	35	0.524	0.6684	0.2341	0.4001	0.4463	201	207	152	189	193	18.5	610
CX2-T101-U14	50	0.387	0.4938	0.2630	0.3703	0.4166	238	245	183	227	233	19.8	750
CX2-T101-U15	70	0.268	0.3422	0.3051	0.3488	0.3950	292	292	227	287	295	21.9	990
CX2-T101-U16	95	0.193	0.2468	0.3315	0.3370	0.3833	347	347	272	347	356	23.1	1240
CX2-T101-U17	120	0.153	0.1960	0.3623	0.3271	0.3733	395	394	314	401	412	24.7	1505
CX2-T101-U18	150	0.124	0.1593	0.3931	0.3172	0.3634	443	441	355	457	466	26.1	1775
CX2-T101-U19	185	0.0991	0.1279	0.4303	0.3059	0.3521	501	498	412	526	536	28	2165
CX2-T101-U20	240	0.0754	0.0983	0.4828	0.2953	0.3416	580	575	476	625	634	30.6	2745
CX2-T101-U30	300	0.0601	0.0794	0.5396	0.2855	0.3317	654	646	544	721	729	33.2	3330
CX2-T101-U40	400	0.047	0.0636	0.5963	0.2790	0.3252	741	727	621	830	840	36.2	4190
CX2-T101-U50	500	0.0366	0.0515	0.6703	0.2696	0.3158	837	815	709	961	966	39.6	5305
CX2-T101-U60	630	0.0283	0.0421	0.7455	0.2640	0.3102	936	904	806	1101	1098	43.5	6670
CX2-T101-U70	800	0.0221	0.0355	0.8401	0.2575	0.3037	1033	988	903	1248	1234	48.2	8535
1 Core - AL/XLPE/PVC													
AX2-T101-U12	25	1.2	1.5386	0.2094	0.4226	0.4688	130	133	98	120	126	17.4	350
AX2-T101-U13	35	0.868	1.1130	0.2341	0.4001	0.4463	156	160	119	145	153	18.5	400
AX2-T101-U14	50	0.641	0.8220	0.2630	0.3703	0.4166	185	189	142	176	184	19.8	465
AX2-T101-U15	70	0.443	0.5682	0.2985	0.3521	0.3983	226	225	177	225	231	21.6	565
AX2-T101-U16	95	0.32	0.4107	0.3315	0.3370	0.3833	271	278	212	273	276	23.1	665
AX2-T101-U17	120	0.253	0.3249	0.3623	0.3271	0.3733	308	317	244	316	324	24.7	775
AX2-T101-U18	150	0.206	0.2648	0.3931	0.3172	0.3634	346	350	276	354	365	26.1	885
AX2-T101-U19	185	0.164	0.2112	0.4303	0.3059	0.3521	393	395	315	414	426	28	1035
AX2-T101-U20	240	0.125	0.1616	0.4806	0.2958	0.3420	456	455	377	487	497	30.5	1255
AX2-T101-U30	300	0.1	0.1299	0.5330	0.2860	0.3323	513	511	424	563	575	32.9	1475
AX2-T101-U40	400	0.0778	0.1021	0.5919	0.2779	0.3241	587	579	492	657	669	36	1815
AX2-T101-U50	500	0.0605	0.0806	0.6682	0.2709	0.3171	671	661	572	771	782	39.7	2215
AX2-T101-U60	630	0.0469	0.0641	0.7444	0.2648	0.3110	762	770	657	896	904	43.6	2750
AX2-T101-U70	800	0.0367	0.0522	0.8488	0.2568	0.3031	858	885	750	1036	1037	48.6	3430

The above data is approximate and subjected to manufacturing tolerance
this data is applicable also for 6.35/11 KV

6/10 (12) KV Multi Core Unarmoured Cables

Three Core Cables, with stranded circular copper or Aluminum conductors, XLPE insulated, and PVC Sheath.



Description

- Stranded circular compacted copper or aluminum conductor, Semi-conducting layer as conductor screen, XLPE insulated, semi-conducting layer as non metallic insulation screen, copper tape or wire as metallic insulation screen, cores are assembled together with non hygroscopic polypropylene fillers and wrapped with binder tape, and PVC sheathed.
- Cables are produced according to IEC 60502.

Application

- These cables are generally suitable for direct burial or for installation on trays or in ducts.

Product Code	Nominal Cross sectional area	Max. Conductor Resistance		Capacitance	Inductance	Current Rating			Approx. Overall Diameter	Approx. Weight
		DC at 20 °C	AC at 90 °C			Ground	Duct	Laid in free air (Shaded)		
		Ω/Km	Ω/Km							
mm ²	Ω/Km	Ω/Km	µf/km	mh/km	A	A	A	mm	Kg/Km	
3 Core - Cu/XLPE/PVC										
CX2-T103-U12	25	0.727	0.9271	0.2094	0.3952	167	125	154	36	1640
CX2-T103-U13	35	0.524	0.6684	0.2341	0.3746	197	148	182	38.6	2000
CX2-T103-U14	50	0.387	0.4938	0.2630	0.3466	233	177	220	41.6	2475
CX2-T103-U15	70	0.268	0.3423	0.3051	0.3257	286	219	275	45.9	3230
CX2-T103-U16	95	0.193	0.2469	0.3315	0.3154	343	263	336	48.7	4045
CX2-T103-U17	120	0.153	0.1962	0.3623	0.3053	390	302	388	51.9	4865
CX2-T103-U18	150	0.124	0.1595	0.3931	0.2968	438	341	442	55.2	5750
CX2-T103-U19	185	0.0991	0.1282	0.4303	0.2856	496	388	508	59	6950
CX2-T103-U20	240	0.0754	0.0987	0.4828	0.2757	575	454	601	64.6	8805
CX2-T103-U30	300	0.0601	0.0799	0.5396	0.2678	655	523	706	70.6	10720
CX2-T103-U40	400	0.047	0.0642	0.5963	0.2607	732	590	794	76.7	13390
CX2-T103-U50	500	0.0366	0.0522	0.6703	0.2533	825	672	916	84.4	16985
3 Core - AL/XLPE/PVC										
AX2-T103-U12	25	1.2	1.5386	0.2094	0.3952	129	97	120	36	1190
AX2-T103-U13	35	0.868	1.1130	0.2341	0.3746	152	115	141	38.6	1380
AX2-T103-U14	50	0.641	0.8220	0.2630	0.3466	181	137	171	41.6	1620
AX2-T103-U15	70	0.443	0.5683	0.2985	0.3286	222	170	214	45.3	1955
AX2-T103-U16	95	0.32	0.4108	0.3315	0.3154	266	204	260	48.7	2315
AX2-T103-U17	120	0.253	0.3250	0.3623	0.3053	303	234	301	51.9	2675
AX2-T103-U18	150	0.206	0.2650	0.3931	0.2968	340	265	343	55.2	3070
AX2-T103-U19	185	0.164	0.2114	0.4303	0.2856	386	303	396	59	3560
AX2-T103-U20	240	0.125	0.1618	0.4806	0.2761	449	355	470	64.4	4325
AX2-T103-U30	300	0.1	0.1302	0.5330	0.2681	509	406	542	70	5160
AX2-T103-U40	400	0.0778	0.1025	0.5919	0.2594	582	469	633	76.2	6255
AX2-T103-U50	500	0.0605	0.0811	0.6682	0.2546	673	548	754	84.6	7710

The above data is approximate and subjected to manufacturing tolerance
this data is applicable also for 6.35/11 KV

6/10 (12) KV Single Core ATA Cables

Single Core Cables, with stranded circular copper or Aluminum conductors, XLPE insulated, aluminum tape armoured and PVC Sheath.



Description

- Stranded circular compacted copper or aluminum conductor, Semi-conducting layer as conductor screen, XLPE insulated, semi-conducting layer as non metallic insulation screen, copper tape or wire as metallic insulation screen, covered with a layer of PVC compound as bedding layer, aluminum tape armoured and PVC sheath.
- Cables are produced according to IEC 60502.

Application

- These cables are generally suitable for direct burial or for installation on trays or in ducts.

Product Code	Nominal Cross sectional area	Max. Conductor Resistance		Capacitance	Inductance		Current Rating					Approx. Overall Diameter	Approx. Weight
		DC at 20 °C	AC at 90 °C		Trefoil	Flat	Laid in ground			Laid in free air (Shaded)			
							Flat	Trefoil	Duct	Flat Touched	Trefoil Touched		
		mm ²	Ω/Km		Ω/Km	µf/km	mh/km	A	A	A	A		

1 Core - Cu/XLPE/ATA/PVC

CX2-T101-B12	25	0.727	0.9271	0.2094	0.4658	0.5120	168	168	134	162	165	21.6	715
CX2-T101-B13	35	0.524	0.6683	0.2341	0.4410	0.4872	201	201	161	196	201	22.7	835
CX2-T101-B14	50	0.387	0.4937	0.2630	0.4088	0.4550	239	238	194	236	241	24	990
CX2-T101-B15	70	0.268	0.3421	0.3051	0.3824	0.4286	292	291	235	294	500	25.9	1240
CX2-T101-B16	95	0.193	0.2467	0.3315	0.3704	0.4167	349	347	282	357	364	27.3	1520
CX2-T101-B17	120	0.153	0.1959	0.3623	0.3571	0.4033	395	393	323	412	419	28.7	1785
CX2-T101-B18	150	0.124	0.1591	0.3931	0.3470	0.3932	444	439	374	468	476	30.3	2085
CX2-T101-B19	185	0.0991	0.1277	0.4303	0.3338	0.3800	501	494	413	537	544	32.2	2495
CX2-T101-B20	240	0.0754	0.0980	0.4828	0.3199	0.3661	580	569	482	634	640	34.6	3090
CX2-T101-B30	300	0.0601	0.0791	0.5396	0.3093	0.3555	654	636	548	729	731	37.4	3715
CX2-T101-B40	400	0.047	0.0631	0.5963	0.3000	0.3462	739	713	625	840	835	40.2	4590
CX2-T101-B50	500	0.0366	0.0509	0.6703	0.2898	0.3360	833	794	713	969	953	43.8	5765
CX2-T101-B60	630	0.0283	0.0414	0.7455	0.2824	0.3287	931	874	805	1107	1074	47.7	7170
CX2-T101-B70	800	0.0221	0.0348	0.8401	0.2742	0.3204	1025	947	899	1250	1193	52.4	9085

1 Core - AL/XLPE/ATA/PVC

AX2-T101-B12	25	1.2	1.5386	0.2094	0.4658	0.5120	131	130	104	125	128	21.6	565
AX2-T101-B13	35	0.868	1.1130	0.2341	0.4410	0.4872	157	156	124	152	156	22.7	630
AX2-T101-B14	50	0.641	0.8220	0.2630	0.4088	0.4550	185	185	149	183	187	24	705
AX2-T101-B15	70	0.443	0.5682	0.2985	0.3861	0.4323	227	226	187	227	234	25.6	815
AX2-T101-B16	95	0.32	0.4106	0.3315	0.3704	0.4167	270	270	219	276	284	27.3	940
AX2-T101-B17	120	0.253	0.3248	0.3623	0.3571	0.4033	309	306	244	320	327	28.7	1055
AX2-T101-B18	150	0.206	0.2647	0.3931	0.3470	0.3932	344	342	282	363	370	30.3	1195
AX2-T101-B19	185	0.164	0.2111	0.4303	0.3338	0.3800	390	387	322	419	426	32.2	1365
AX2-T101-B20	240	0.125	0.1614	0.4806	0.3204	0.3667	452	448	377	495	503	34.5	1595
AX2-T101-B30	300	0.1	0.1297	0.5330	0.3101	0.3563	512	504	430	571	577	37.1	1860
AX2-T101-B40	400	0.0778	0.1018	0.5919	0.2990	0.3452	585	574	494	660	671	40	2215
AX2-T101-B50	500	0.0605	0.0803	0.6682	0.2910	0.3372	669	648	571	777	776	43.9	2675
AX2-T101-B60	630	0.0469	0.0637	0.7444	0.2832	0.3294	759	727	679	901	891	47.8	3250
AX2-T101-B70	800	0.0367	0.0517	0.8488	0.2734	0.3196	853	807	750	1041	1016	52.8	3990

The above data is approximate and subjected to manufacturing tolerance
this data is applicable also for 6.35/11 KV

6/10 (12) KV Multi Core STA Cables

Three Core Cables, with stranded circular copper or Aluminum conductors, XLPE insulated, Steel tape armoured and PVC Sheath.



Description

- Stranded circular compacted copper or aluminum conductor, Semi-conducting layer as conductor screen, XLPE insulated, semi-conducting layer as non metallic insulation screen, copper tape or wire as metallic insulation screen, cores are assembled together with non hygroscopic polypropylene fillers and wrapped with binder tape, covered with a layer of PVC compound as bedding, steel tape armoured and PVC sheathed.
- Cables are produced according to IEC 60502.

Application

- These cables are generally suitable for direct burial or for installation on trays or in ducts.

Product Code	Nominal Cross sectional area mm ²	Max. Conductor Resistance		Capacitance µf/km	Inductance mh/km	Current Rating			Approx. Overall Diameter mm	Approx. Weight Kg/Km
		DC at 20 °C Ω/Km	AC at 90 °C Ω/Km			Ground A	Duct A	Laid in free air (Shaded) A		
3 Core - Cu/XLPE/STA/PVC										
CX2-T103-G12	25	0.727	0.9271	0.2094	0.3952	157	124	147	40.6	2480
CX2-T103-G13	35	0.524	0.6684	0.2341	0.3746	189	148	179	43	2870
CX2-T103-G14	50	0.387	0.4938	0.2630	0.3466	222	176	214	46.4	3455
CX2-T103-G15	70	0.268	0.3423	0.3051	0.3257	272	217	266	50.9	4335
CX2-T103-G16	95	0.193	0.2469	0.3315	0.3154	325	260	321	53.5	5190
CX2-T103-G17	120	0.153	0.1962	0.3623	0.3053	369	297	368	56.7	6085
CX2-T103-G18	150	0.124	0.1595	0.3931	0.2968	413	332	417	60	7040
CX2-T103-G19	185	0.0991	0.1282	0.4303	0.2856	464	377	475	64	8360
CX2-T103-G20	240	0.0754	0.0987	0.4828	0.2757	535	436	556	69.6	10345
CX2-T103-G30	300	0.0601	0.0799	0.5396	0.2678	598	493	632	75.8	12435
CX2-T103-G40	400	0.047	0.0642	0.5963	0.2607	675	561	724	83.3	16065
CX2-T103-G50	500	0.0366	0.0522	0.6703	0.2533	754	634	822	91.2	19965
3 Core - AL/XLPE/STA/PVC										
AX2-T103-G12	25	1.2	1.5386	0.2094	0.3952	122	96	115	40.6	2030
AX2-T103-G13	35	0.868	1.1130	0.2341	0.3746	146	115	139	43	2255
AX2-T103-G14	50	0.641	0.8220	0.2630	0.3466	173	136	166	46.4	2600
AX2-T103-G15	70	0.443	0.5683	0.2985	0.3286	211	169	206	50.3	3045
AX2-T103-G16	95	0.32	0.4108	0.3315	0.3154	253	202	249	53.5	3460
AX2-T103-G17	120	0.253	0.3250	0.3623	0.3053	288	231	287	56.7	3895
AX2-T103-G18	150	0.206	0.2650	0.3931	0.2968	322	259	326	60	4365
AX2-T103-G19	185	0.164	0.2114	0.4303	0.2856	364	296	372	64	4970
AX2-T103-G20	240	0.125	0.1618	0.4806	0.2761	421	344	437	69.4	5860
AX2-T103-G30	300	0.1	0.1302	0.5330	0.2681	474	391	499	75.2	6865
AX2-T103-G40	400	0.0778	0.1025	0.5919	0.2594	542	451	580	82.8	8915
AX2-T103-G50	500	0.0605	0.0811	0.6682	0.2546	615	518	670	91.4	10700

The above data is approximate and subjected to manufacturing tolerance
this data is applicable also for 6.35/11 KV

6/10 (12) KV Single Core AWA Cables

Single Core Cables, with stranded Circular copper or Aluminum conductors, XLPE insulated, aluminum wire armoured and PVC Sheath.



Description

- Stranded circular compacted copper or aluminum conductor, Semi-conducting layer as conductor screen, XLPE insulated, semi-conducting layer as non metallic insulation screen, copper tape or wire as metallic insulation screen, covered with a layer of PVC compound as bedding layer, aluminum wire armoured and PVC sheath.
- Cables are produced according to IEC 60502 or BS 6622.

Application

- These cables are generally suitable for direct burial or for installation on trays or in ducts.

Product Code	Nominal Cross sectional area	Max. Conductor Resistance		Capacitance	Inductance		Current Rating					Approx. Overall Diameter	Approx. Weight
		DC at 20 °C	AC at 90 °C		Trefoil	Flat	Laid in ground			Laid in free air (Shaded)			
							Flat	Trefoil	Duct	Flat Touched	Trefoil Touched		
		mm ²	Ω/Km		Ω/Km	µf/km	mh/km	A	A	A	A		
1 Core - Cu/XLPE/AWA/PVC													
CX2-T101-X12	25	0.727	0.9271	0.2094	0.4827	0.5289	169	169	136	164	168	23.5	825
CX2-T101-X13	35	0.524	0.6683	0.2341	0.4571	0.5033	202	202	163	199	203	24.6	955
CX2-T101-X14	50	0.387	0.4937	0.2630	0.4241	0.4703	239	238	193	239	243	25.9	1115
CX2-T101-X15	70	0.268	0.3421	0.3051	0.3980	0.4442	292	290	237	297	301	28	1390
CX2-T101-X16	95	0.193	0.2466	0.3315	0.3839	0.4301	346	344	283	359	362	29.2	1665
CX2-T101-X17	120	0.153	0.1958	0.3623	0.3744	0.4207	391	387	322	414	413	31.3	2000
CX2-T101-X18	150	0.124	0.1590	0.3931	0.3635	0.4097	437	431	361	468	465	32.9	2310
CX2-T101-X19	185	0.0991	0.1276	0.4303	0.3482	0.3944	491	481	408	534	525	34.6	2710
CX2-T101-X20	240	0.0754	0.0979	0.4828	0.3344	0.3806	562	543	471	624	605	37.2	3345
CX2-T101-X30	300	0.0601	0.0789	0.5396	0.3217	0.3680	628	597	530	711	681	39.8	3975
CX2-T101-X40	400	0.047	0.0628	0.5963	0.3171	0.3633	690	636	589	802	747	43.8	5025
CX2-T101-X50	500	0.0366	0.0505	0.6703	0.3056	0.3518	763	691	660	910	830	47.4	6225
CX2-T101-X60	630	0.0283	0.0410	0.7455	0.2970	0.3432	835	739	729	1019	909	51.3	7680
CX2-T101-X70	800	0.0221	0.0343	0.8401	0.2875	0.3337	905	784	798	1130	992	56	9640
1 Core - AL/XLPE/AWA/PVC													
AX2-T101-X12	25	1.2	1.5386	0.2094	0.4827	0.5289	131	131	105	128	131	23.5	675
AX2-T101-X13	35	0.868	1.1130	0.2341	0.4571	0.5033	157	157	126	155	158	24.6	745
AX2-T101-X14	50	0.641	0.8220	0.2630	0.4241	0.4703	186	185	150	186	190	25.9	830
AX2-T101-X15	70	0.443	0.5682	0.2985	0.4018	0.4481	227	226	184	232	236	27.7	960
AX2-T101-X16	95	0.32	0.4106	0.3315	0.3839	0.4301	270	269	221	280	284	29.2	1085
AX2-T101-X17	120	0.253	0.3248	0.3623	0.3744	0.4207	307	305	252	324	327	31.3	1270
AX2-T101-X18	150	0.206	0.2647	0.3931	0.3635	0.4097	342	340	283	367	369	32.9	1415
AX2-T101-X19	185	0.164	0.2110	0.4303	0.3482	0.3944	387	383	322	420	420	34.6	1580
AX2-T101-X20	240	0.125	0.1613	0.4806	0.3350	0.3812	446	439	374	494	490	37.1	1850
AX2-T101-X30	300	0.1	0.1296	0.5330	0.3226	0.3688	500	490	423	566	555	39.5	2115
AX2-T101-X40	400	0.0778	0.1016	0.5919	0.3162	0.3624	561	537	480	652	626	43.6	2635
AX2-T101-X50	500	0.0605	0.0800	0.6682	0.3067	0.3530	631	593	546	750	707	47.5	3145
AX2-T101-X60	630	0.0469	0.0634	0.7444	0.2977	0.3439	705	650	616	856	794	51.4	3760
AX2-T101-X70	800	0.0367	0.0513	0.8488	0.2866	0.3328	781	705	691	974	886	56.4	4540

The above data is approximate and subjected to manufacturing tolerance this data is applicable also for 6.35/11 KV

6/10 (12) KV Multi Core SWA Cables

Three Core Cables, with stranded circular copper or Aluminum conductors, XLPE insulated, Steel wire armoured and PVC Sheath.



Description

- Stranded circular compacted copper or aluminum conductor, Semi-conducting layer as conductor screen, XLPE insulated, semi-conducting layer as non metallic insulation screen, copper tape or wire as metallic insulation screen, cores are assembled together with non hygroscopic polypropylene fillers and wrapped with binder tape, covered with a layer of PVC compound as bedding, steel wire armoured and PVC sheathed.
- Cables are produced according to IEC 60502 or BS 6622.

Application

- These cables are generally suitable for direct burial or for installation on trays or in ducts.

Product Code	Nominal Cross sectional area	Max. Conductor Resistance		Capacitance	Inductance	Current Rating			Approx. Overall Diameter	Approx. Weight
		DC at 20 °C	AC at 90 °C			Ground	Duct	Laid in free air (Shaded)		
		Ω/Km	Ω/Km							
mm ²	Ω/Km	Ω/Km	µf/km	mh/km	A	A	A	mm	Kg/Km	
3 Core - Cu/XLPE/SWA/PVC										
CX2-T103-W12	25	0.727	0.9271	0.2094	0.3952	158	126	150	43.8	3710
CX2-T103-W13	35	0.524	0.6684	0.2341	0.3746	190	150	182	46.4	4175
CX2-T103-W14	50	0.387	0.4938	0.2630	0.3466	224	178	217	49.6	4855
CX2-T103-W15	70	0.268	0.3423	0.3051	0.3257	275	221	271	53.9	5815
CX2-T103-W16	95	0.193	0.2469	0.3315	0.3154	327	264	326	56.7	6775
CX2-T103-W17	120	0.153	0.1962	0.3623	0.3053	370	299	373	59.9	7790
CX2-T103-W18	150	0.124	0.1595	0.3931	0.2968	415	336	423	63.2	8825
CX2-T103-W19	185	0.0991	0.1282	0.4303	0.2856	466	381	480	67.2	10295
CX2-T103-W20	240	0.0754	0.0987	0.4828	0.2757	534	440	561	74.9	13305
CX2-T103-W30	300	0.0601	0.0799	0.5396	0.2678	595	495	635	80.9	15665
CX2-T103-W40	400	0.047	0.0642	0.5963	0.2607	663	556	718	87.2	18765
CX2-T103-W50	500	0.0366	0.0522	0.6703	0.2533	733	619	808	95.1	22935
3 Core - AL/XLPE/SWA/PVC										
AX2-T103-W12	25	1.2	1.5386	0.2094	0.3952	123	98	117	43.8	3260
AX2-T103-W13	35	0.868	1.1130	0.2341	0.3746	147	117	141	46.4	3555
AX2-T103-W14	50	0.641	0.8220	0.2630	0.3466	174	138	169	49.6	4000
AX2-T103-W15	70	0.443	0.5683	0.2985	0.3286	213	170	209	53.3	4530
AX2-T103-W16	95	0.32	0.4108	0.3315	0.3154	254	205	253	56.7	5045
AX2-T103-W17	120	0.253	0.3250	0.3623	0.3053	289	233	291	59.9	5600
AX2-T103-W18	150	0.206	0.2650	0.3931	0.2968	324	262	330	63.2	6150
AX2-T103-W19	185	0.164	0.2114	0.4303	0.2856	365	299	376	67.2	6905
AX2-T103-W20	240	0.125	0.1618	0.4806	0.2761	422	348	443	74.7	8820
AX2-T103-W30	300	0.1	0.1302	0.5330	0.2681	474	394	504	80.3	10035
AX2-T103-W40	400	0.0778	0.1025	0.5919	0.2594	536	450	579	86.7	11560
AX2-T103-W50	500	0.0605	0.0811	0.6682	0.2546	605	511	664	95.3	13670

The above data is approximate and subjected to manufacturing tolerance
this data is applicable also for 6.35/11 KV

8.7/15 (17.5) KV Single Core Unarmoured Cables

Single Core Cables, with stranded Circular copper or Aluminum conductors, XLPE insulated, and PVC Sheath.



Description

- Stranded circular compacted copper or aluminum conductor, Semi-conducting layer as conductor screen, XLPE insulated, semi-conducting layer as non metallic insulation screen, copper tape or wire as metallic insulation screen, and PVC sheathed.
- Cables are produced according to IEC 60502.

Application

- These cables are generally suitable for direct burial or for installation on trays or in ducts.

Product Code	Nominal Cross sectional area	Max. Conductor Resistance		Capacitance	Inductance		Current Rating					Approx. Overall Diameter	Approx. Weight
		DC at 20 °C	AC at 90 °C		Trefoil	Flat	Laid in ground			Laid in free air (Shaded)			
							Flat	Trefoil	Duct	Flat Touched	Trefoil Touched		
		mm ²	Ω/Km		Ω/Km	µf/km	mh/km	A	A	A	A		
1 Core - Cu/XLPE/PVC													
CX3-T101-U12	25	0.727	0.9271	0.1699	0.4464	0.4926	168	172	127	155	159	19.6	570
CX3-T101-U13	35	0.524	0.6683	0.1886	0.4245	0.4707	201	207	152	189	193	20.9	690
CX3-T101-U14	50	0.387	0.4937	0.2104	0.3932	0.4394	238	245	183	227	234	22.2	840
CX3-T101-U15	70	0.268	0.3422	0.2421	0.3696	0.4158	292	295	227	287	295	24.3	1085
CX3-T101-U16	95	0.193	0.2467	0.2620	0.3568	0.4030	347	351	272	347	356	25.5	1345
CX3-T101-U17	120	0.153	0.1959	0.2851	0.3456	0.3918	395	398	314	403	412	27.1	1615
CX3-T101-U18	150	0.124	0.1592	0.3081	0.3348	0.3810	443	445	355	458	466	28.5	1890
CX3-T101-U19	185	0.0991	0.1278	0.3360	0.3223	0.3685	501	502	412	527	536	30.4	2285
CX3-T101-U20	240	0.0754	0.0981	0.3752	0.3104	0.3567	580	578	478	626	634	33	2875
CX3-T101-U30	300	0.0601	0.0792	0.4177	0.2994	0.3457	658	648	547	723	731	35.6	3470
CX3-T101-U40	400	0.047	0.0633	0.4600	0.2908	0.3370	746	726	623	830	841	38.4	4325
CX3-T101-U50	500	0.0366	0.0511	0.5153	0.2814	0.3276	840	817	711	962	968	42	5470
CX3-T101-U60	630	0.0283	0.0417	0.5713	0.2739	0.3201	940	906	806	1102	1098	45.7	6825
CX3-T101-U70	800	0.0221	0.0351	0.6419	0.2672	0.3134	1035	988	903	1248	1234	50.6	8730
1 Core - AL/XLPE/PVC													
AX3-T101-U12	25	1.2	1.5386	0.1699	0.4464	0.4926	132	133	102	120	126	19.6	420
AX3-T101-U13	35	0.868	1.1130	0.1886	0.4245	0.4707	158	160	123	145	153	20.9	485
AX3-T101-U14	50	0.641	0.8220	0.2104	0.3932	0.4394	188	189	146	179	184	22.2	555
AX3-T101-U15	70	0.443	0.5682	0.2371	0.3732	0.4194	228	229	181	225	231	24	660
AX3-T101-U16	95	0.32	0.4106	0.2620	0.3568	0.4030	275	278	216	273	280	25.5	770
AX3-T101-U17	120	0.253	0.3249	0.2851	0.3456	0.3918	312	320	249	316	324	27.1	885
AX3-T101-U18	150	0.206	0.2648	0.3081	0.3348	0.3810	350	354	280	359	369	28.5	995
AX3-T101-U19	185	0.164	0.2111	0.3360	0.3223	0.3685	396	398	319	414	426	30.4	1155
AX3-T101-U20	240	0.125	0.1615	0.3736	0.3109	0.3572	460	459	377	491	505	32.9	1385
AX3-T101-U30	300	0.1	0.1298	0.4128	0.3001	0.3463	517	515	429	566	580	35.3	1615
AX3-T101-U40	400	0.0778	0.1019	0.4568	0.2898	0.3360	591	584	497	661	675	38.2	1950
AX3-T101-U50	500	0.0605	0.0804	0.5137	0.2826	0.3288	675	667	575	773	790	42.1	2380
AX3-T101-U60	630	0.0469	0.0639	0.5705	0.2746	0.3209	768	778	660	901	912	45.8	2910
AX3-T101-U70	800	0.0367	0.0519	0.6484	0.2665	0.3127	863	890	760	1042	1042	51	3630

The above data is approximate and subjected to manufacturing tolerance

8.7/15 (17.5) KV Multi Core Unarmoured Cables

Three Core Cables, with stranded circular copper or Aluminum conductors, XLPE insulated, and PVC Sheath.



Description

- Stranded circular compacted copper or aluminum conductor, Semi-conducting layer as conductor screen, XLPE insulated, semi-conducting layer as non metallic insulation screen, copper tape or wire as metallic insulation screen, cores are assembled together with non hygroscopic polypropylene fillers and wrapped with binder tape, and PVC sheathed.
- Cables are produced according to IEC 60502.

Application

- These cables are generally suitable for direct burial or for installation on trays or in ducts.

Product Code	Nominal Cross sectional area	Max. Conductor Resistance		Capacitance	Inductance	Current Rating			Approx. Overall Diameter	Approx. Weight
		DC at 20 °C	AC at 90 °C			Ground	Duct	Laid in free air (Shaded)		
		Ω/Km	Ω/Km							
mm ²	Ω/Km	Ω/Km	µf/km	mh/km	A	A	A	mm	Kg/Km	
3 Core - Cu/XLPE/PVC										
CX3-T103-U12	25	0.727	0.9271	0.1699	0.4238	167	128	158	41.2	1940
CX3-T103-U13	35	0.524	0.6684	0.1886	0.4014	197	152	187	43.8	2320
CX3-T103-U14	50	0.387	0.4938	0.2104	0.3715	234	181	225	46.8	2815
CX3-T103-U15	70	0.268	0.3422	0.2421	0.3482	286	223	281	51.1	3600
CX3-T103-U16	95	0.193	0.2468	0.2620	0.3366	343	268	341	53.9	4435
CX3-T103-U17	120	0.153	0.1960	0.2851	0.3252	390	307	394	57.1	5275
CX3-T103-U18	150	0.124	0.1594	0.3081	0.3156	438	346	448	60.3	6180
CX3-T103-U19	185	0.0991	0.1280	0.3360	0.3030	496	394	514	64.2	7415
CX3-T103-U20	240	0.0754	0.0984	0.3752	0.2917	575	461	608	69.8	9305
CX3-T103-U30	300	0.0601	0.0796	0.4177	0.2824	657	530	712	75.6	11230
CX3-T103-U40	400	0.047	0.0638	0.4600	0.2742	734	598	802	81.8	13970
CX3-T103-U50	500	0.0366	0.0518	0.5153	0.2655	829	682	924	89.5	17620
3 Core - AL/XLPE/PVC										
AX3-T103-U12	25	1.2	1.5386	0.1699	0.4238	129	99	122	41.2	1490
AX3-T103-U13	35	0.868	1.1130	0.1886	0.4014	153	118	145	43.8	1700
AX3-T103-U14	50	0.641	0.8220	0.2104	0.3715	181	140	174	46.8	1960
AX3-T103-U15	70	0.443	0.5683	0.2371	0.3514	222	173	218	50.4	2315
AX3-T103-U16	95	0.32	0.4107	0.2620	0.3366	266	208	265	53.9	2705
AX3-T103-U17	120	0.253	0.3249	0.2851	0.3252	303	238	306	57.1	3085
AX3-T103-U18	150	0.206	0.2649	0.3081	0.3156	340	269	348	60.3	3505
AX3-T103-U19	185	0.164	0.2113	0.3360	0.3030	386	307	401	64.2	4025
AX3-T103-U20	240	0.125	0.1617	0.3736	0.2921	449	360	474	69.6	4825
AX3-T103-U30	300	0.1	0.1300	0.4128	0.2829	509	411	547	74.9	5655
AX3-T103-U40	400	0.0778	0.1022	0.4568	0.2730	583	475	637	81.4	6840
AX3-T103-U50	500	0.0605	0.0808	0.5137	0.2668	673	554	757	89.8	8355

The above data is approximate and subjected to manufacturing tolerance

8.7/15 (17.5) KV Single Core ATA Cables

Single Core Cables, with stranded Circular copper or Aluminum conductors, XLPE insulated, aluminum tape armoured and PVC Sheath.



Description

- Stranded circular compacted copper or aluminum conductor, Semi-conducting layer as conductor screen, XLPE insulated, semi-conducting layer as non metallic insulation screen, copper tape or wire as metallic insulation screen, covered with a layer of PVC compound as bedding layer, aluminum tape armoured and PVC sheath.
- Cables are produced according to IEC 60502.

Application

- These cables are generally suitable for direct burial or for installation on trays or in ducts.

Product Code	Nominal Cross sectional area	Max. Conductor Resistance		Capacitance	Inductance		Current Rating					Approx. Overall Diameter	Approx. Weight
		DC at 20 °C	AC at 90 °C		Trefoil	Flat	Laid in ground			Laid in free air (Shaded)			
							Flat	Trefoil	Duct	Flat Touched	Trefoil Touched		
		mm ²	Ω/Km		Ω/Km	µf/km	mh/km	A	A	A	A		
1 Core - Cu/XLPE/ATA/PVC													
CX3-T101-B12	25	0.727	0.9271	0.1699	0.4852	0.5314	168	168	136	165	167	23.8	810
CX3-T101-B13	35	0.524	0.6683	0.1886	0.4595	0.5057	201	201	164	199	203	24.9	930
CX3-T101-B14	50	0.387	0.4937	0.2104	0.4279	0.4741	238	237	197	239	242	26.4	1105
CX3-T101-B15	70	0.268	0.3421	0.2421	0.4001	0.4463	291	290	239	297	303	28.3	1360
CX3-T101-B16	95	0.193	0.2466	0.2620	0.3873	0.4335	349	346	286	359	367	29.7	1645
CX3-T101-B17	120	0.153	0.1958	0.2851	0.3732	0.4194	394	392	327	416	422	31.1	1920
CX3-T101-B18	150	0.124	0.1591	0.3081	0.3623	0.4085	443	438	379	471	479	32.7	2225
CX3-T101-B19	185	0.0991	0.1276	0.3360	0.3470	0.3933	501	493	419	540	547	34.4	2625
CX3-T101-B20	240	0.0754	0.0979	0.3752	0.3333	0.3796	581	568	486	637	643	37	3245
CX3-T101-B30	300	0.0601	0.0789	0.4177	0.3207	0.3670	654	630	554	731	734	39.6	3865
CX3-T101-B40	400	0.047	0.0629	0.4600	0.3116	0.3578	739	712	630	843	837	42.6	4765
CX3-T101-B50	500	0.0366	0.0506	0.5153	0.3013	0.3475	812	793	719	971	953	46.4	5980
CX3-T101-B60	630	0.0283	0.0411	0.5713	0.2923	0.3385	931	874	814	1111	1075	50.1	7375
CX3-T101-B70	800	0.0221	0.0344	0.6419	0.2839	0.3301	1026	947	907	1253	1194	55	9340
1 Core - AL/XLPE/ATA/PVC													
AX3-T101-B12	25	1.2	1.5386	0.1699	0.4852	0.5314	131	130	106	127	130	23.8	660
AX3-T101-B13	35	0.868	1.1130	0.1886	0.4595	0.5057	157	155	127	154	157	24.9	725
AX3-T101-B14	50	0.641	0.8220	0.2104	0.4279	0.4741	185	184	151	185	189	26.4	820
AX3-T101-B15	70	0.443	0.5682	0.2371	0.4040	0.4502	227	225	190	230	236	28	935
AX3-T101-B16	95	0.32	0.4106	0.2620	0.3873	0.4335	270	271	221	279	286	29.7	1070
AX3-T101-B17	120	0.253	0.3248	0.2851	0.3732	0.4194	308	306	248	323	329	31.1	1190
AX3-T101-B18	150	0.206	0.2647	0.3081	0.3623	0.4085	343	341	286	366	373	32.7	1335
AX3-T101-B19	185	0.164	0.2110	0.3360	0.3470	0.3933	390	387	327	422	429	34.4	1495
AX3-T101-B20	240	0.125	0.1613	0.3736	0.3339	0.3801	457	447	381	497	505	36.9	1750
AX3-T101-B30	300	0.1	0.1296	0.4128	0.3216	0.3678	512	503	434	573	579	39.3	2010
AX3-T101-B40	400	0.0778	0.1016	0.4568	0.3106	0.3569	584	572	499	667	672	42.4	2390
AX3-T101-B50	500	0.0605	0.0801	0.5137	0.3025	0.3487	670	646	576	778	776	46.5	2890
AX3-T101-B60	630	0.0469	0.0635	0.5705	0.2930	0.3392	760	726	685	903	892	50.2	3460
AX3-T101-B70	800	0.0367	0.0514	0.6484	0.2830	0.3292	853	809	753	1042	1016	55.4	4240

The above data is approximate and subjected to manufacturing tolerance

8.7/15 (17.5) KV Multi Core STA Cables

Three Core Cables, with stranded circular copper or Aluminum conductors, XLPE insulated, Steel tape armoured and PVC Sheath.



Description

- Stranded circular compacted copper or aluminum conductor, Semi-conducting layer as conductor screen, XLPE insulated, semi-conducting layer as non metallic insulation screen, copper tape or wire as metallic insulation screen, cores are assembled together with non hygroscopic polypropylene fillers and wrapped with binder tape, covered with a layer of PVC compound as bedding, steel tape armoured and PVC sheathed.
- Cables are produced according to IEC 60502.

Application

- These cables are generally suitable for direct burial or for installation on trays or in ducts.

Product Code	Nominal Cross sectional area	Max. Conductor Resistance		Capacitance	Inductance	Current Rating			Approx. Overall Diameter	Approx. Weight
		DC at 20 °C	AC at 90 °C			Ground	Duct	Laid in free air (Shaded)		
		mm ²	Ω/Km							
3 Core - Cu/XLPE/STA/PVC										
CX3-T103-G12	25	0.727	0.9271	0.1699	0.4238	158	126	150	45.8	2895
CX3-T103-G13	35	0.524	0.6684	0.1886	0.4014	189	151	182	48.4	3330
CX3-T103-G14	50	0.387	0.4938	0.2104	0.3715	223	179	217	51.6	3915
CX3-T103-G15	70	0.268	0.3422	0.2421	0.3482	274	221	271	55.7	4770
CX3-T103-G16	95	0.193	0.2468	0.2620	0.3366	325	263	325	58.7	5695
CX3-T103-G17	120	0.153	0.1960	0.2851	0.3252	368	300	372	62.1	6645
CX3-T103-G18	150	0.124	0.1594	0.3081	0.3156	412	337	421	65.3	7620
CX3-T103-G19	185	0.0991	0.1280	0.3360	0.3030	464	381	479	69.2	8945
CX3-T103-G20	240	0.0754	0.0984	0.3752	0.2917	534	442	559	75	11005
CX3-T103-G30	300	0.0601	0.0796	0.4177	0.2824	602	502	640	82.4	13910
CX3-T103-G40	400	0.047	0.0638	0.4600	0.2742	676	568	729	88.4	16820
CX3-T103-G50	500	0.0366	0.0518	0.5153	0.2655	755	639	827	96.3	20775
3 Core - AL/XLPE/STA/PVC										
AX3-T103-G12	25	1.2	1.5386	0.1699	0.4238	122	98	117	45.8	2445
AX3-T103-G13	35	0.868	1.1130	0.1886	0.4014	146	117	141	48.4	2710
AX3-T103-G14	50	0.641	0.8220	0.2104	0.3715	173	139	168	51.6	3060
AX3-T103-G15	70	0.443	0.5683	0.2371	0.3514	212	171	209	55	3470
AX3-T103-G16	95	0.32	0.4107	0.2620	0.3366	253	205	253	58.7	3965
AX3-T103-G17	120	0.253	0.3249	0.2851	0.3252	287	234	290	62.1	4455
AX3-T103-G18	150	0.206	0.2649	0.3081	0.3156	322	263	328	65.3	4945
AX3-T103-G19	185	0.164	0.2113	0.3360	0.3030	364	299	375	69.2	5555
AX3-T103-G20	240	0.125	0.1617	0.3736	0.2921	421	348	440	74.8	6520
AX3-T103-G30	300	0.1	0.1300	0.4128	0.2829	476	397	504	81.7	8310
AX3-T103-G40	400	0.0778	0.1022	0.4568	0.2730	542	455	582	88	9675
AX3-T103-G50	500	0.0605	0.0808	0.5137	0.2668	615	521	673	96.6	11525

The above data is approximate and subjected to manufacturing tolerance

8.7/15 (17.5) KV Single Core AWA Cables

Single Core Cables, with stranded Circular copper or Aluminum conductors, XLPE insulated, aluminum wire armoured and PVC Sheath.



Description

- Stranded circular compacted copper or aluminum conductor, Semi-conducting layer as conductor screen, XLPE insulated, semi-conducting layer as non metallic insulation screen, copper tape or wire as metallic insulation screen, covered with a layer of PVC compound as bedding layer, aluminum wire armoured and PVC sheath.
- Cables are produced according to IEC 60502 or BS 6622.

Application

- These cables are generally suitable for direct burial or for installation on trays or in ducts.

Product Code	Nominal Cross sectional area	Max. Conductor Resistance		Capacitance	Inductance		Current Rating					Approx. Overall Diameter	Approx. Weight
		DC at 20 °C	AC at 90 °C		Laid in ground			Laid in free air (Shaded)					
					Trefoil	Flat	Flat Trefoil	Trefoil Trefoil	Trefoil Trefoil				
		mm ²	Ω/Km		Ω/Km	µf/km	mh/km	A	A	A	A		
1 Core - Cu/XLPE/AWA/PVC													
CX3-T101-X12	25	0.727	0.9271	0.1699	0.5006	0.5468	169	168	137	166	169	25.7	935
CX3-T101-X13	35	0.524	0.6683	0.1886	0.4757	0.5219	201	201	165	202	205	27	1075
CX3-T101-X14	50	0.387	0.4937	0.2104	0.4418	0.4880	238	237	195	242	245	28.3	1245
CX3-T101-X15	70	0.268	0.3421	0.2421	0.4144	0.4606	290	289	239	300	303	30.4	1525
CX3-T101-X16	95	0.193	0.2466	0.2620	0.4028	0.4491	346	343	286	364	365	32.1	1850
CX3-T101-X17	120	0.153	0.1958	0.2851	0.3892	0.4354	391	386	325	417	416	33.7	2150
CX3-T101-X18	150	0.124	0.1590	0.3081	0.3764	0.4227	436	430	365	471	468	35.1	2450
CX3-T101-X19	185	0.0991	0.1275	0.3360	0.3616	0.4078	489	479	411	536	527	37	2880
CX3-T101-X20	240	0.0754	0.0978	0.3752	0.3459	0.3921	561	542	475	628	609	39.4	3495
CX3-T101-X30	300	0.0601	0.0788	0.4177	0.3325	0.3787	627	596	534	714	684	42	4125
CX3-T101-X40	400	0.047	0.0627	0.4600	0.3278	0.3740	689	636	595	805	749	46.2	5220
CX3-T101-X50	500	0.0366	0.0503	0.5153	0.3163	0.3625	763	689	665	913	835	50	6465
CX3-T101-X60	630	0.0283	0.0407	0.5713	0.3061	0.3524	837	742	736	1023	916	53.7	7900
CX3-T101-X70	800	0.0221	0.0340	0.6419	0.2959	0.3421	907	787	806	1136	996	58.4	9895
1 Core - AL/XLPE/AWA/PVC													
AX3-T101-X12	25	1.2	1.5386	0.1699	0.5006	0.5468	131	131	107	129	132	25.7	785
AX3-T101-X13	35	0.868	1.1130	0.1886	0.4757	0.5219	156	156	128	157	160	27	870
AX3-T101-X14	50	0.641	0.8220	0.2104	0.4418	0.4880	185	185	152	188	191	28.3	960
AX3-T101-X15	70	0.443	0.5682	0.2371	0.4185	0.4647	226	226	187	234	238	30.1	1100
AX3-T101-X16	95	0.32	0.4106	0.2620	0.4028	0.4491	270	269	224	284	287	32.1	1275
AX3-T101-X17	120	0.253	0.3248	0.2851	0.3892	0.4354	307	304	255	326	329	33.7	1420
AX3-T101-X18	150	0.206	0.2646	0.3081	0.3764	0.4227	342	339	286	369	371	35.1	1555
AX3-T101-X19	185	0.164	0.2110	0.3360	0.3616	0.4078	385	382	325	422	422	37	1750
AX3-T101-X20	240	0.125	0.1613	0.3736	0.3465	0.3927	445	438	377	496	491	39.3	2005
AX3-T101-X30	300	0.1	0.1295	0.4128	0.3334	0.3797	501	489	426	568	558	41.7	2265
AX3-T101-X40	400	0.0778	0.1015	0.4568	0.3269	0.3731	561	536	484	653	628	46	2845
AX3-T101-X50	500	0.0605	0.0799	0.5137	0.3174	0.3636	632	593	551	752	712	50.1	3375
AX3-T101-X60	630	0.0469	0.0632	0.5705	0.3068	0.3531	707	651	621	858	798	53.8	3985
AX3-T101-X70	800	0.0367	0.0511	0.6484	0.2949	0.3412	782	707	696	976	890	58.8	4795

The above data is approximate and subjected to manufacturing tolerance

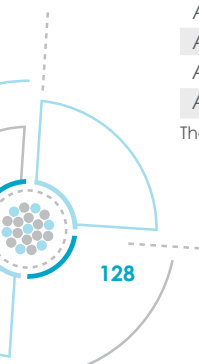

8.7/15 (17.5) KV Multi Core SWA Cables

Three Core Cables, with stranded circular copper or Aluminum conductors, XLPE insulated, Steel wire armoured and PVC Sheath.



Description

- Stranded circular compacted copper or aluminum conductor, Semi-conducting layer as conductor screen, XLPE insulated, semi-conducting layer as non metallic insulation screen, copper tape or wire as metallic insulation screen, cores are assembled together with non hygroscopic polypropylene fillers and wrapped with binder tape, covered with a layer of PVC compound as bedding, steel wire armoured and PVC sheathed.
- Cables are produced according to IEC 60502 or BS 6622.

Application

- These cables are generally suitable for direct burial or for installation on trays or in ducts.

Product Code	Nominal Cross sectional area	Max. Conductor Resistance		Capacitance	Inductance	Current Rating			Approx. Overall Diameter	Approx. Weight
		DC at 20 °C	AC at 90 °C			Ground	Duct	Laid in free air (Shaded)		
3 Core - Cu/XLPE/SWA/PVC										
CX3-T103-W12	25	0.727	0.9271	0.1699	0.4238	159	127	153	49	4260
CX3-T103-W13	35	0.524	0.6684	0.1886	0.4014	190	153	185	51.6	4780
CX3-T103-W14	50	0.387	0.4938	0.2104	0.3715	224	182	220	54.6	5425
CX3-T103-W15	70	0.268	0.3422	0.2421	0.3482	275	223	275	58.9	6445
CX3-T103-W16	95	0.193	0.2468	0.2620	0.3366	327	266	329	61.9	7455
CX3-T103-W17	120	0.153	0.1960	0.2851	0.3252	370	303	376	65.3	8485
CX3-T103-W18	150	0.124	0.1594	0.3081	0.3156	415	342	428	70.2	10310
CX3-T103-W19	185	0.0991	0.1280	0.3360	0.3030	464	385	484	74.5	11910
CX3-T103-W20	240	0.0754	0.0984	0.3752	0.2917	533	445	564	80.1	14180
CX3-T103-W30	300	0.0601	0.0796	0.4177	0.2824	594	498	638	86.1	16525
CX3-T103-W40	400	0.047	0.0638	0.4600	0.2742	663	559	721	92.3	19660
CX3-T103-W50	500	0.0366	0.0518	0.5153	0.2655	734	625	812	100.2	23890
3 Core - AL/XLPE/SWA/PVC										
AX3-T103-W12	25	1.2	1.5386	0.1699	0.4238	123	99	118	49	3810
AX3-T103-W13	35	0.868	1.1130	0.1886	0.4014	147	119	143	51.6	4165
AX3-T103-W14	50	0.641	0.8220	0.2104	0.3715	174	141	171	54.6	4570
AX3-T103-W15	70	0.443	0.5683	0.2371	0.3514	213	173	212	58.2	5120
AX3-T103-W16	95	0.32	0.4107	0.2620	0.3366	254	207	256	61.9	5730
AX3-T103-W17	120	0.253	0.3249	0.2851	0.3252	289	236	293	65.3	6295
AX3-T103-W18	150	0.206	0.2649	0.3081	0.3156	324	267	334	70.2	7635
AX3-T103-W19	185	0.164	0.2113	0.3360	0.3030	365	303	380	74.5	8520
AX3-T103-W20	240	0.125	0.1617	0.3736	0.2921	421	350	445	79.9	9695
AX3-T103-W30	300	0.1	0.1300	0.4128	0.2829	473	397	506	85.4	10880
AX3-T103-W40	400	0.0778	0.1022	0.4568	0.2730	536	452	580	91.9	12525
AX3-T103-W50	500	0.0605	0.0808	0.5137	0.2668	604	516	666	100.5	14630

The above data is approximate and subjected to manufacturing tolerance

12/20 (24) KV Single Core Unarmoured Cables

Single Core Cables, with stranded Circular copper or Aluminum conductors, XLPE insulated, and PVC Sheath.



Description

- Stranded circular compacted copper or aluminum conductor, Semi-conducting layer as conductor screen, XLPE insulated, semi-conducting layer as non metallic insulation screen, copper tape or wire as metallic insulation screen, and PVC sheathed.
- Cables are produced according to IEC 60502.

Application

- These cables are generally suitable for direct burial or for installation on trays or in ducts.

Product Code	Nominal Cross sectional area	Max. Conductor Resistance		Capacitance	Inductance		Current Rating					Approx. Overall Diameter	Approx. Weight
		DC at 20 °C	AC at 90 °C		Trefoil	Flat	Laid in ground			Laid in free air (Shaded)			
							Flat	Trefoil	Duct	Flat Touched	Trefoil Touched		
		mm ²	Ω/Km		Ω/Km	µf/km	mh/km	A	A	A	A		
1 Core - Cu/XLPE/PVC													
CX4-T101-U13	35	0.524	0.6683	0.1632	0.4428	0.4890	201	207	152	189	193	22.9	765
CX4-T101-U14	50	0.387	0.4937	0.1812	0.4121	0.4583	238	245	183	227	234	24.4	930
CX4-T101-U15	70	0.268	0.3421	0.2072	0.3854	0.4317	292	297	227	287	295	26.3	1170
CX4-T101-U16	95	0.193	0.2467	0.2235	0.3734	0.4196	347	353	275	347	360	27.7	1445
CX4-T101-U17	120	0.153	0.1959	0.2424	0.3599	0.4061	397	402	318	403	416	29.1	1710
CX4-T101-U18	150	0.124	0.1591	0.2612	0.3496	0.3959	443	448	358	460	468	30.7	2005
CX4-T101-U19	185	0.0991	0.1277	0.2839	0.3351	0.3813	501	505	416	523	540	32.4	2390
CX4-T101-U20	240	0.0754	0.0980	0.3159	0.3222	0.3684	580	579	481	630	638	35	2990
CX4-T101-U30	300	0.0601	0.0790	0.3505	0.3114	0.3577	662	650	550	725	736	37.8	3605
CX4-T101-U40	400	0.047	0.0631	0.3850	0.3020	0.3482	750	729	625	832	841	40.6	4470
CX4-T101-U50	500	0.0366	0.0508	0.4300	0.2916	0.3378	844	819	711	962	971	44.2	5635
CX4-T101-U60	630	0.0283	0.0414	0.4755	0.2833	0.3295	945	906	807	1104	1099	47.9	7000
CX4-T101-U70	800	0.0221	0.0347	0.5329	0.2750	0.3212	1035	988	904	1249	1238	52.6	8895
1 Core - AL/XLPE/PVC													
AX4-T101-U13	35	0.868	1.1130	0.1632	0.4428	0.4890	158	160	123	149	153	22.9	560
AX4-T101-U14	50	0.641	0.8220	0.1812	0.4121	0.4583	188	189	148	185	188	24.4	645
AX4-T101-U15	70	0.443	0.5682	0.2031	0.3892	0.4354	228	232	181	229	235	26	745
AX4-T101-U16	95	0.32	0.4106	0.2235	0.3734	0.4196	275	278	222	277	284	27.7	870
AX4-T101-U17	120	0.253	0.3248	0.2424	0.3599	0.4061	312	320	254	320	328	29.1	980
AX4-T101-U18	150	0.206	0.2647	0.2612	0.3496	0.3959	350	354	286	363	372	30.7	1110
AX4-T101-U19	185	0.164	0.2111	0.2839	0.3351	0.3813	396	405	322	417	428	32.4	1260
AX4-T101-U20	240	0.125	0.1614	0.3146	0.3227	0.3690	460	465	381	495	509	34.9	1495
AX4-T101-U30	300	0.1	0.1297	0.3465	0.3122	0.3584	517	520	435	570	586	37.5	1755
AX4-T101-U40	400	0.0778	0.1017	0.3823	0.3010	0.3472	591	600	505	665	680	40.4	2095
AX4-T101-U50	500	0.0605	0.0802	0.4286	0.2928	0.3390	675	675	580	779	798	44.3	2540
AX4-T101-U60	630	0.0469	0.0637	0.4749	0.2840	0.3303	768	790	675	905	920	48	3080
AX4-T101-U70	800	0.0367	0.0517	0.5382	0.2742	0.3204	863	894	766	1049	1060	53	3800

The above data is approximate and subjected to manufacturing tolerance this data is applicable also for 12.7/22 KV

12/20 (24) KV Multi Core Unarmoured Cables

Three Core Cables, with stranded circular copper or Aluminum conductors, XLPE insulated, and PVC Sheath.



Description

- Stranded circular compacted copper or aluminum conductor, Semi-conducting layer as conductor screen, XLPE insulated, semi-conducting layer as non metallic insulation screen, copper tape or wire as metallic insulation screen, cores are assembled together with non hygroscopic polypropylene fillers and wrapped with binder tape, and PVC sheathed.
- Cables are produced according to IEC 60502.

Application

- These cables are generally suitable for direct burial or for installation on trays or in ducts.

Product Code	Nominal Cross sectional area	Max. Conductor Resistance		Capacitance	Inductance	Current Rating			Approx. Overall Diameter	Approx. Weight
		DC at 20 °C	AC at 90 °C			Ground	Duct	Laid in free air (Shaded)		
		Ω/Km	Ω/Km							
mm ²	Ω/Km	Ω/Km	µf/km	mh/km	A	A	A	mm	Kg/Km	
3 Core - Cu/XLPE/PVC										
CX4-T103-U13	35	0.524	0.6683	0.1632	0.4230	200	156	194	48.3	2620
CX4-T103-U14	50	0.387	0.4937	0.1812	0.3917	234	184	229	51.3	3130
CX4-T103-U15	70	0.268	0.3422	0.2072	0.3667	287	226	285	55.6	3940
CX4-T103-U16	95	0.193	0.2467	0.2235	0.3541	343	272	346	58.4	4795
CX4-T103-U17	120	0.153	0.1960	0.2424	0.3417	391	311	398	61.6	5655
CX4-T103-U18	150	0.124	0.1592	0.2612	0.3312	439	351	453	64.8	6580
CX4-T103-U19	185	0.0991	0.1279	0.2839	0.3177	496	399	518	68.9	7870
CX4-T103-U20	240	0.0754	0.0982	0.3159	0.3052	576	466	613	74.3	9760
CX4-T103-U30	300	0.0601	0.0794	0.3505	0.2948	657	536	716	80.3	11755
CX4-T103-U40	400	0.047	0.0636	0.3850	0.2857	736	605	808	86.3	14500
CX4-T103-U50	500	0.0366	0.0514	0.4300	0.2760	832	690	931	94.1	18200
3 Core - AL/XLPE/PVC										
AX4-T103-U13	35	0.868	1.1130	0.1632	0.4230	155	121	151	48.3	2000
AX4-T103-U14	50	0.641	0.8220	0.1812	0.3917	181	142	177	51.3	2275
AX4-T103-U15	70	0.443	0.5682	0.2031	0.3702	223	176	221	54.9	2655
AX4-T103-U16	95	0.32	0.4107	0.2235	0.3541	266	211	268	58.4	3065
AX4-T103-U17	120	0.253	0.3249	0.2424	0.3417	304	242	310	61.6	3465
AX4-T103-U18	150	0.206	0.2648	0.2612	0.3312	341	272	351	64.8	3905
AX4-T103-U19	185	0.164	0.2112	0.2839	0.3177	386	311	404	68.9	4480
AX4-T103-U20	240	0.125	0.1615	0.3146	0.3057	450	364	478	74.1	5280
AX4-T103-U30	300	0.1	0.1299	0.3465	0.2954	509	415	550	79.7	6185
AX4-T103-U40	400	0.0778	0.1020	0.3823	0.2846	584	479	641	85.9	7365
AX4-T103-U50	500	0.0605	0.0806	0.4286	0.2773	674	558	760	94.3	8930

The above data is approximate and subjected to manufacturing tolerance
this data is applicable also for 12.7/22 KV

12/20 (24) KV Single Core ATA Cables

Single Core Cables, with stranded Circular copper or Aluminum conductors, XLPE insulated, aluminum tape armoured and PVC Sheath.



Description

- Stranded circular compacted copper or aluminum conductor, Semi-conducting layer as conductor screen, XLPE insulated, semi-conducting layer as non metallic insulation screen, copper tape or wire as metallic insulation screen, covered with a layer of PVC compound as bedding layer, aluminum tape armoured and PVC sheath.
- Cables are produced according to IEC 60502.

Application

- These cables are generally suitable for direct burial or for installation on trays or in ducts.

Product Code	Nominal Cross sectional area	Max. Conductor Resistance		Capacitance	Inductance		Current Rating					Approx. Overall Diameter	Approx. Weight
		DC at 20 °C	AC at 90 °C		Trefoil	Flat	Laid in ground			Laid in free air (Shaded)			
							Flat	Trefoil	Duct	Flat Touched	Trefoil Touched		
		mm ²	Ω/Km		Ω/Km	µf/km	mh/km	A	A	A	A		
1 Core - Cu/XLPE/ATA/PVC													
CX4-T101-B13	35	0.524	0.6683	0.1632	0.4764	0.5227	201	202	165	201	205	27.1	1040
CX4-T101-B14	50	0.387	0.4937	0.1812	0.4425	0.4887	238	236	199	241	244	28.4	1205
CX4-T101-B15	70	0.268	0.3421	0.2072	0.4151	0.4613	290	289	241	299	305	30.5	1485
CX4-T101-B16	95	0.193	0.2466	0.2235	0.4003	0.4466	348	345	289	361	369	31.7	1760
CX4-T101-B17	120	0.153	0.1958	0.2424	0.3868	0.4330	394	391	330	418	424	33.3	2050
CX4-T101-B18	150	0.124	0.1590	0.2612	0.3741	0.4204	443	437	383	474	481	34.7	2345
CX4-T101-B19	185	0.0991	0.1275	0.2839	0.3594	0.4057	500	492	422	543	549	36.6	2770
CX4-T101-B20	240	0.0754	0.0978	0.3159	0.3439	0.3901	580	567	492	639	646	39	3375
CX4-T101-B30	300	0.0601	0.0788	0.3505	0.3325	0.3787	653	633	559	731	735	42	4045
CX4-T101-B40	400	0.047	0.0628	0.3850	0.3216	0.3679	738	711	635	844	838	44.8	4940
CX4-T101-B50	500	0.0366	0.0504	0.4300	0.3106	0.3568	832	792	723	973	954	48.6	6165
CX4-T101-B60	630	0.0283	0.0409	0.4755	0.3016	0.3478	930	872	808	1112	1075	52.5	7600
CX4-T101-B70	800	0.0221	0.0342	0.5329	0.2910	0.3373	1027	947	914	1256	1196	57	9525
1 Core - AL/XLPE/ATA/PVC													
AX4-T101-B13	35	0.868	1.1130	0.1632	0.4764	0.5227	156	155	128	155	159	27.1	835
AX4-T101-B14	50	0.641	0.8220	0.1812	0.4425	0.4887	184	184	153	187	191	28.4	920
AX4-T101-B15	70	0.443	0.5682	0.2031	0.4191	0.4653	226	224	192	231	238	30.2	1055
AX4-T101-B16	95	0.32	0.4106	0.2235	0.4003	0.4466	269	271	223	281	288	31.7	1180
AX4-T101-B17	120	0.253	0.3248	0.2424	0.3868	0.4330	308	305	250	325	331	33.3	1320
AX4-T101-B18	150	0.206	0.2646	0.2612	0.3741	0.4204	343	341	289	368	374	34.7	1455
AX4-T101-B19	185	0.164	0.2110	0.2839	0.3594	0.4057	389	386	329	424	430	36.6	1640
AX4-T101-B20	240	0.125	0.1613	0.3146	0.3444	0.3907	451	446	386	499	507	38.9	1885
AX4-T101-B30	300	0.1	0.1295	0.3465	0.3334	0.3797	511	502	437	574	578	41.7	2190
AX4-T101-B40	400	0.0778	0.1015	0.3823	0.3207	0.3670	583	571	502	669	673	44.6	2565
AX4-T101-B50	500	0.0605	0.0799	0.4286	0.3117	0.3580	669	645	578	779	776	48.7	3075
AX4-T101-B60	630	0.0469	0.0633	0.4749	0.3023	0.3486	759	724	690	903	891	52.6	3680
AX4-T101-B70	800	0.0367	0.0512	0.5382	0.2901	0.3363	853	809	760	1042	1016	57.4	4430

The above data is approximate and subjected to manufacturing tolerance
this data is applicable also for 12.7/22 KV

12/20 (24) KV Multi Core STA Cables

Three Core Cables, with stranded circular copper or Aluminum conductors, XLPE insulated, Steel tape armoured and PVC Sheath.



Description

- Stranded circular compacted copper or aluminum conductor, Semi-conducting layer as conductor screen, XLPE insulated, semi-conducting layer as non metallic insulation screen, copper tape or wire as metallic insulation screen, cores are assembled together with non hygroscopic polypropylene fillers and wrapped with binder tape, covered with a layer of PVC compound as bedding, steel tape armoured and PVC sheathed.
- Cables are produced according to IEC 60502.

Application

- These cables are generally suitable for direct burial or for installation on trays or in ducts.

Product Code	Nominal Cross sectional area	Max. Conductor Resistance		Capacitance	Inductance	Current Rating			Approx. Overall Diameter	Approx. Weight
		DC at 20 °C	AC at 90 °C			Ground	Duct	Laid in free air (Shaded)		
3 Core - Cu/XLPE/STA/PVC										
CX4-T103-G13	35	0.524	0.6683	0.1632	0.4230	189	153	184	53.1	3755
CX4-T103-G14	50	0.387	0.4937	0.1812	0.3917	223	181	220	56.1	4335
CX4-T103-G15	70	0.268	0.3422	0.2072	0.3667	274	224	274	60.4	5245
CX4-T103-G16	95	0.193	0.2467	0.2235	0.3541	325	267	328	63.4	6190
CX4-T103-G17	120	0.153	0.1960	0.2424	0.3417	368	303	374	66.8	7165
CX4-T103-G18	150	0.124	0.1592	0.2612	0.3312	413	340	424	69.8	8125
CX4-T103-G19	185	0.0991	0.1279	0.2839	0.3177	464	385	481	74.1	9545
CX4-T103-G20	240	0.0754	0.0982	0.3159	0.3052	537	449	565	81.1	12400
CX4-T103-G30	300	0.0601	0.0794	0.3505	0.2948	602	508	643	86.9	14560
CX4-T103-G40	400	0.047	0.0636	0.3850	0.2857	676	571	730	93.3	17590
CX4-T103-G50	500	0.0366	0.0514	0.4300	0.2760	756	646	831	101.1	21570
3 Core - AL/XLPE/STA/PVC										
AX4-T103-G13	35	0.868	1.1130	0.1632	0.4230	146	118	143	53.1	3140
AX4-T103-G14	50	0.641	0.8220	0.1812	0.3917	173	141	171	56.1	3480
AX4-T103-G15	70	0.443	0.5682	0.2031	0.3702	212	173	212	59.7	3940
AX4-T103-G16	95	0.32	0.4107	0.2235	0.3541	253	208	255	63.4	4465
AX4-T103-G17	120	0.253	0.3249	0.2424	0.3417	287	237	292	66.8	4975
AX4-T103-G18	150	0.206	0.2648	0.2612	0.3312	322	265	330	69.8	5450
AX4-T103-G19	185	0.164	0.2112	0.2839	0.3177	364	302	377	74.1	6155
AX4-T103-G20	240	0.125	0.1615	0.3146	0.3057	422	353	444	80.9	7905
AX4-T103-G30	300	0.1	0.1299	0.3465	0.2954	476	400	507	86.3	8965
AX4-T103-G40	400	0.0778	0.1020	0.3823	0.2846	541	458	583	92.9	10445
AX4-T103-G50	500	0.0605	0.0806	0.4286	0.2773	615	525	674	101.3	12305

The above data is approximate and subjected to manufacturing tolerance
this data is applicable also for 12.7/22 KV

12/20 (24) KV Single Core AWA Cables

Single Core Cables, with stranded Circular copper or Aluminum conductors, XLPE insulated, aluminum wire armoured and PVC Sheath.



Description

- Stranded circular compacted copper or aluminum conductor, Semi-conducting layer as conductor screen, XLPE insulated, semi-conducting layer as non metallic insulation screen, copper tape or wire as metallic insulation screen, covered with a layer of PVC compound as bedding layer, aluminum wire armoured and PVC sheath,
- Cables are produced according to IEC 60502 or BS 6622.

Application

- These cables are generally suitable for direct burial or for installation on trays or in ducts.

Product Code	Nominal Cross sectional area	Max. Conductor Resistance		Capacitance	Inductance		Current Rating					Approx. Overall Diameter	Approx. Weight
		DC at 20 °C	AC at 90 °C		Laid in ground			Laid in free air (Shaded)					
					Trefoil	Flat	Flat Trefoil	Trefoil Trefoil	Trefoil Trefoil				
		mm ²	Ω/Km		Ω/Km	µf/km	mh/km	A	A	A	A		
1 Core - Cu/XLPE/AWA/PVC													
CX4-T101-X13	35	0.524	0.6683	0.1632	0.4900	0.5362	201	201	166	203	207	29	1185
CX4-T101-X14	50	0.387	0.4937	0.1812	0.4567	0.5030	238	237	197	244	247	30.5	1365
CX4-T101-X15	70	0.268	0.3421	0.2072	0.4314	0.4777	290	288	242	303	306	33.1	1705
CX4-T101-X16	95	0.193	0.2466	0.2235	0.4161	0.4623	345	342	289	366	366	34.3	1990
CX4-T101-X17	120	0.153	0.1957	0.2424	0.4019	0.4481	390	385	328	419	418	35.9	2295
CX4-T101-X18	150	0.124	0.1590	0.2612	0.3886	0.4348	435	429	368	473	468	37.3	2600
CX4-T101-X19	185	0.0991	0.1275	0.2839	0.3721	0.4184	488	478	414	539	530	39	3015
CX4-T101-X20	240	0.0754	0.0977	0.3159	0.3558	0.4020	560	541	479	630	611	41.4	3635
CX4-T101-X30	300	0.0601	0.0786	0.3505	0.3490	0.3952	617	582	534	712	675	45.6	4485
CX4-T101-X40	400	0.047	0.0625	0.3850	0.3371	0.3833	689	636	599	808	753	48.4	5410
CX4-T101-X50	500	0.0366	0.0501	0.4300	0.3249	0.3711	763	689	669	914	834	52.2	6685
CX4-T101-X60	630	0.0283	0.0406	0.4755	0.3142	0.3604	838	742	741	1026	921	55.9	8130
CX4-T101-X70	800	0.0221	0.0338	0.5329	0.3033	0.3495	909	789	812	1140	1002	60.6	10125
1 Core - AL/XLPE/AWA/PVC													
AX4-T101-X13	35	0.868	1.1130	0.1632	0.4900	0.5362	156	156	129	158	161	29	975
AX4-T101-X14	50	0.641	0.8220	0.1812	0.4567	0.5030	185	184	154	189	193	30.5	1080
AX4-T101-X15	70	0.443	0.5682	0.2031	0.4356	0.4819	226	225	189	236	240	32.8	1280
AX4-T101-X16	95	0.32	0.4106	0.2235	0.4161	0.4623	269	268	226	285	288	34.3	1415
AX4-T101-X17	120	0.253	0.3248	0.2424	0.4019	0.4481	305	303	257	328	330	35.9	1565
AX4-T101-X18	150	0.206	0.2646	0.2612	0.3886	0.4348	341	339	327	370	372	37.3	1710
AX4-T101-X19	185	0.164	0.2109	0.2839	0.3721	0.4184	385	381	380	424	424	39	1885
AX4-T101-X20	240	0.125	0.1612	0.3146	0.3564	0.4026	444	438	380	498	493	41.3	2145
AX4-T101-X30	300	0.1	0.1294	0.3465	0.3500	0.3962	495	480	428	568	553	45.3	2630
AX4-T101-X40	400	0.0778	0.1014	0.3823	0.3363	0.3825	560	535	487	654	630	48.2	3035
AX4-T101-X50	500	0.0605	0.0798	0.4286	0.3260	0.3722	631	592	553	752	711	52.3	3595
AX4-T101-X60	630	0.0469	0.0631	0.4749	0.3149	0.3611	706	650	625	859	800	56	4210
AX4-T101-X70	800	0.0367	0.0509	0.5382	0.3023	0.3485	782	707	700	977	893	61	5030

The above data is approximate and subjected to manufacturing tolerance
this data is applicable also for 12.7/22 KV

12/20 (24) KV Multi Core SWA Cables

Three Core Cables, with stranded circular copper or Aluminum conductors, XLPE insulated, Steel wire armoured and PVC Sheath.



Description

- Stranded circular compacted copper or aluminum conductor, Semi-conducting layer as conductor screen, XLPE insulated, semi-conducting layer as non metallic insulation screen, copper tape or wire as metallic insulation screen, cores are assembled together with non hygroscopic polypropylene fillers and wrapped with binder tape, covered with a layer of PVC compound as bedding, steel wire armoured and PVC sheathed.
- Cables are produced according to IEC 60502 or BS 6622.

Application

- These cables are generally suitable for direct burial or for installation on trays or in ducts.

Product Code	Nominal Cross sectional area	Max. Conductor Resistance		Capacitance	Inductance	Current Rating			Approx. Overall Diameter	Approx. Weight
		DC at 20 °C	AC at 90 °C			Ground	Duct	Laid in free air (Shaded)		
3 Core - Cu/XLPE/SWA/PVC										
CX4-T103-W13	35	0.524	0.6683	0.1632	0.4230	190	155	186	56.3	5345
CX4-T103-W14	50	0.387	0.4937	0.1812	0.3917	225	183	223	59.3	6010
CX4-T103-W15	70	0.268	0.3422	0.2072	0.3667	275	226	277	63.6	7060
CX4-T103-W16	95	0.193	0.2467	0.2235	0.3541	326	268	331	66.6	8090
CX4-T103-W17	120	0.153	0.1960	0.2424	0.3417	370	307	380	71.9	9995
CX4-T103-W18	150	0.124	0.1592	0.2612	0.3312	413	344	429	75.1	11080
CX4-T103-W19	185	0.0991	0.1279	0.2839	0.3177	464	387	486	79.2	12670
CX4-T103-W20	240	0.0754	0.0982	0.3159	0.3052	532	447	565	84.8	14980
CX4-T103-W30	300	0.0601	0.0794	0.3505	0.2948	593	502	639	90.8	17360
CX4-T103-W40	400	0.047	0.0636	0.3850	0.2857	661	563	721	97.2	20585
CX4-T103-W50	500	0.0366	0.0514	0.4300	0.2760	734	628	814	105	24830
3 Core - AL/XLPE/SWA/PVC										
AX4-T103-W13	35	0.868	1.1130	0.1632	0.4230	147	120	144	56.3	4730
AX4-T103-W14	50	0.641	0.8220	0.1812	0.3917	174	142	173	59.3	5155
AX4-T103-W15	70	0.443	0.5682	0.2031	0.3702	213	175	214	62.9	5730
AX4-T103-W16	95	0.32	0.4107	0.2235	0.3541	254	209	258	66.6	6365
AX4-T103-W17	120	0.253	0.3249	0.2424	0.3417	289	240	297	71.9	7805
AX4-T103-W18	150	0.206	0.2648	0.2612	0.3312	323	269	335	75.1	8405
AX4-T103-W19	185	0.164	0.2112	0.2839	0.3177	365	304	381	79.2	9280
AX4-T103-W20	240	0.125	0.1615	0.3146	0.3057	421	354	446	84.6	10495
AX4-T103-W30	300	0.1	0.1299	0.3465	0.2954	473	400	507	90.2	11720
AX4-T103-W40	400	0.0778	0.1020	0.3823	0.2846	534	455	581	96.8	13445
AX4-T103-W50	500	0.0605	0.0806	0.4286	0.2773	604	517	667	105.2	15560

The above data is approximate and subjected to manufacturing tolerance
this data is applicable also for 12.7/22 KV

18/30 (36) KV Single Core Unarmoured Cables

Single Core Cables, with stranded Circular copper or Aluminum conductors, XLPE insulated, and PVC Sheath.



Description

- Stranded circular compacted copper or aluminum conductor, Semi-conducting layer as conductor screen, XLPE insulated, semi-conducting layer as non metallic insulation screen, copper tape or wire as metallic insulation screen, and PVC sheathed.
- Cables are produced according to IEC 60502.

Application

- These cables are generally suitable for direct burial or for installation on trays or in ducts.

Product Code	Nominal Cross sectional area	Max. Conductor Resistance		Capacitance	Inductance		Current Rating					Approx. Overall Diameter	Approx. Weight
		DC at 20 °C	AC at 90 °C		Trefoil	Flat	Laid in ground			Laid in free air (Shaded)			
							Flat	Trefoil	Duct	Flat Touched	Trefoil Touched		
		mm ²	Ω/Km		Ω/Km	µf/km	mh/km		A	A	A		
1 Core - Cu/XLPE/PVC													
CX5-T101-U14	50	0.387	0.4937	0.1412	0.4508	0.4970	238	245	183	227	238	29.6	1175
CX5-T101-U15	70	0.268	0.3421	0.1596	0.4215	0.4677	292	297	230	290	295	31.5	1430
CX5-T101-U16	95	0.193	0.2466	0.1711	0.4078	0.4540	347	356	279	351	364	32.9	1715
CX5-T101-U17	120	0.153	0.1958	0.1844	0.3927	0.4390	397	404	322	407	420	34.3	1990
CX5-T101-U18	150	0.124	0.1590	0.1976	0.3809	0.4272	447	451	362	464	471	35.9	2300
CX5-T101-U19	185	0.0991	0.1275	0.2135	0.3648	0.4111	505	509	420	527	544	37.6	2700
CX5-T101-U20	240	0.0754	0.0977	0.2358	0.3499	0.3961	585	583	485	633	641	40.2	3320
CX5-T101-U30	300	0.0601	0.0787	0.2599	0.3372	0.3834	666	654	554	729	740	43	3960
CX5-T101-U40	400	0.047	0.0627	0.2839	0.3261	0.3723	754	731	629	834	845	45.8	4850
CX5-T101-U50	500	0.0366	0.0503	0.3151	0.3138	0.3601	848	821	713	965	973	49.4	6040
CX5-T101-U60	630	0.0283	0.0408	0.3467	0.3039	0.3501	949	908	810	1106	1099	53.1	7440
CX5-T101-U70	800	0.0221	0.0341	0.3864	0.2938	0.3400	1039	990	908	1251	1238	57.8	9375
1 Core - AL/XLPE/PVC													
AX5-T101-U14	50	0.641	0.8220	0.1412	0.4508	0.4970	188	189	152	185	193	29.6	890
AX5-T101-U15	70	0.443	0.5682	0.1567	0.4256	0.4719	228	232	189	232	239	31.2	1005
AX5-T101-U16	95	0.32	0.4106	0.1711	0.4078	0.4540	279	278	222	282	288	32.9	1140
AX5-T101-U17	120	0.253	0.3248	0.1844	0.3927	0.4390	316	320	259	324	332	34.3	1260
AX5-T101-U18	150	0.206	0.2646	0.1976	0.3809	0.4272	354	354	290	367	379	35.9	1405
AX5-T101-U19	185	0.164	0.2110	0.2135	0.3648	0.4111	400	405	322	425	433	37.6	1570
AX5-T101-U20	240	0.125	0.1612	0.2349	0.3505	0.3967	460	468	386	499	513	40.1	1830
AX5-T101-U30	300	0.1	0.1295	0.2571	0.3382	0.3844	517	526	440	575	590	42.7	2105
AX5-T101-U40	400	0.0778	0.1015	0.2820	0.3252	0.3714	591	605	510	672	685	45.6	2475
AX5-T101-U50	500	0.0605	0.0799	0.3142	0.3150	0.3612	679	684	587	786	803	49.5	2950
AX5-T101-U60	630	0.0469	0.0632	0.3462	0.3046	0.3508	772	794	680	909	933	53.2	3520
AX5-T101-U70	800	0.0367	0.0512	0.3900	0.2929	0.3391	870	899	772	1053	1075	58.2	4275

The above data is approximate and subjected to manufacturing tolerance
this data is applicable also for 19/33 KV

18/30 (36) KV Multi Core Unarmoured Cables

Three Core Cables, with stranded circular copper or Aluminum conductors, XLPE insulated, and PVC Sheath.



Description

- Stranded circular compacted copper or aluminum conductor, Semi-conducting layer as conductor screen, XLPE insulated, semi-conducting layer as non metallic insulation screen, copper tape or wire as metallic insulation screen, cores are assembled together with non hygroscopic polypropylene fillers and wrapped with binder tape, and PVC sheathed.
- Cables are produced according to IEC 60502.

Application

- These cables are generally suitable for direct burial or for installation on trays or in ducts.

Product Code	Nominal Cross sectional area	Max. Conductor Resistance		Capacitance	Inductance	Current Rating			Approx. Overall Diameter	Approx. Weight
		DC at 20 °C	AC at 90 °C			Ground	Duct	Laid in free air (Shaded)		
		Ω/Km	Ω/Km							
mm ²	Ω/Km	Ω/Km	μf/km	mh/km	A	A	A	mm	Kg/Km	
3 Core - Cu/XLPE/PVC										
CX5-T103-U14	50	0.387	0.4937	0.1412	0.4333	236	191	239	62.5	4055
CX5-T103-U15	70	0.268	0.3421	0.1596	0.4052	287	233	292	66.8	4930
CX5-T103-U16	95	0.193	0.2466	0.1711	0.3909	344	280	353	69.6	5825
CX5-T103-U17	120	0.153	0.1958	0.1844	0.3766	391	319	406	72.8	6735
CX5-T103-U18	150	0.124	0.1591	0.1976	0.3645	439	360	461	76	7705
CX5-T103-U19	185	0.0991	0.1276	0.2135	0.3492	497	409	527	79.9	9025
CX5-T103-U20	240	0.0754	0.0979	0.2358	0.3344	577	477	621	85.5	11035
CX5-T103-U30	300	0.0601	0.0790	0.2599	0.3219	657	547	722	91.5	13120
CX5-T103-U40	400	0.047	0.0630	0.2839	0.3110	738	619	817	97.5	15950
CX5-T103-U50	500	0.0366	0.0508	0.3151	0.2993	836	706	941	105.2	19765
3 Core - AL/XLPE/PVC										
AX5-T103-U14	50	0.641	0.8220	0.1412	0.4333	183	148	185	62.5	3200
AX5-T103-U15	70	0.443	0.5682	0.1567	0.4091	223	181	226	66.1	3635
AX5-T103-U16	95	0.32	0.4106	0.1711	0.3909	266	217	274	69.6	4095
AX5-T103-U17	120	0.253	0.3248	0.1844	0.3766	304	248	316	72.8	4545
AX5-T103-U18	150	0.206	0.2647	0.1976	0.3645	341	279	357	76	5030
AX5-T103-U19	185	0.164	0.2110	0.2135	0.3492	387	318	411	79.9	5635
AX5-T103-U20	240	0.125	0.1613	0.2349	0.3350	450	372	484	85.2	6540
AX5-T103-U30	300	0.1	0.1297	0.2571	0.3228	509	424	556	90.8	7535
AX5-T103-U40	400	0.0778	0.1017	0.2820	0.3100	584	489	647	97.1	8815
AX5-T103-U50	500	0.0605	0.0802	0.3142	0.3005	674	568	764	105.5	10505

The above data is approximate and subjected to manufacturing tolerance
this data is applicable also for 19/33 KV

18/30 (36) KV Single Core ATA Cables

Single Core Cables, with stranded Circular copper or Aluminum conductors, XLPE insulated, aluminum tape armoured and PVC Sheath.



Description

- Stranded circular compacted copper or aluminum conductor, Semi-conducting layer as conductor screen, XLPE insulated, semi-conducting layer as non metallic insulation screen, copper tape or wire as metallic insulation screen, covered with a layer of PVC compound as bedding layer, aluminum tape armoured and PVC sheath.
- Cables are produced according to IEC 60502.

Application

- These cables are generally suitable for direct burial or for installation on trays or in ducts.

Product Code	Nominal Cross sectional area	Max. Conductor Resistance		Capacitance	Inductance		Current Rating					Approx. Overall Diameter	Approx. Weight
		DC at 20 °C	AC at 90 °C		Trefoil	Flat	Laid in ground			Laid in free air (Shaded)			
							Flat	Trefoil	Duct	Flat Touched	Trefoil Touched		
		mm ²	Ω/Km		Ω/Km	µf/km	mh/km	A	A	A	A		
1 Core - Cu/XLPE/ATA/PVC													
CX5-T101-B14	50	0.387	0.4937	0.1412	0.4761	0.5223	237	235	200	245	248	33.6	1505
CX5-T101-B15	70	0.268	0.3421	0.1596	0.4466	0.4928	289	287	247	303	309	35.7	1800
CX5-T101-B16	95	0.193	0.2466	0.1711	0.4307	0.4769	347	343	295	365	372	36.9	2085
CX5-T101-B17	120	0.153	0.1957	0.1844	0.4148	0.4610	392	389	373	423	428	38.3	2370
CX5-T101-B18	150	0.124	0.1589	0.1976	0.4021	0.4483	441	435	390	478	485	39.9	2695
CX5-T101-B19	185	0.0991	0.1274	0.2135	0.3860	0.4322	498	489	431	547	552	41.8	3135
CX5-T101-B20	240	0.0754	0.0976	0.2358	0.3698	0.4160	580	504	500	643	648	44.4	3785
CX5-T101-B30	300	0.0601	0.0785	0.2599	0.3558	0.4021	651	630	567	734	736	47.2	4460
CX5-T101-B40	400	0.047	0.0625	0.2839	0.3436	0.3898	736	709	645	847	839	50	5375
CX5-T101-B50	500	0.0366	0.0500	0.3151	0.3309	0.3771	831	789	733	976	955	53.8	6630
CX5-T101-B60	630	0.0283	0.0404	0.3467	0.3198	0.3660	931	871	720	1116	1077	57.5	8075
CX5-T101-B70	800	0.0221	0.0336	0.3864	0.3085	0.3547	1028	946	929	1260	1196	62.2	10065
1 Core - AL/XLPE/ATA/PVC													
AX5-T101-B14	50	0.641	0.8220	0.1412	0.4761	0.5223	184	185	157	189	193	33.6	1220
AX5-T101-B15	70	0.443	0.5682	0.1567	0.4509	0.4971	225	223	196	235	241	35.4	1370
AX5-T101-B16	95	0.32	0.4106	0.1711	0.4307	0.4769	268	269	228	284	291	36.9	1510
AX5-T101-B17	120	0.253	0.3247	0.1844	0.4148	0.4610	307	303	255	328	334	38.3	1640
AX5-T101-B18	150	0.206	0.2646	0.1976	0.4021	0.4483	342	339	294	371	377	39.9	1805
AX5-T101-B19	185	0.164	0.2109	0.2135	0.3860	0.4322	388	384	336	427	433	41.8	2005
AX5-T101-B20	240	0.125	0.1611	0.2349	0.3704	0.4167	449	444	391	502	509	44.3	2290
AX5-T101-B30	300	0.1	0.1294	0.2571	0.3569	0.4032	509	498	414	577	579	46.9	2600
AX5-T101-B40	400	0.0778	0.1013	0.2820	0.3428	0.3890	582	568	510	670	673	49.8	2995
AX5-T101-B50	500	0.0605	0.0797	0.3142	0.3320	0.3782	667	642	586	780	775	53.9	3540
AX5-T101-B60	630	0.0469	0.0630	0.3462	0.3205	0.3667	758	721	699	903	889	57.6	4155
AX5-T101-B70	800	0.0367	0.0508	0.3900	0.3075	0.3537	852	806	769	1042	1013	62.6	4970

The above data is approximate and subjected to manufacturing tolerance
this data is applicable also for 19/33 KV

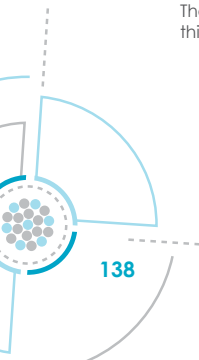

18/30 (36) KV Multi Core STA Cables

Single Core Cables, with stranded Circular copper or Aluminum conductors, XLPE insulated, steel tape armoured and PVC Sheath.



Description

- Stranded circular compacted copper or aluminum conductor, Semi-conducting layer as conductor screen, XLPE insulated, semi-conducting layer as non metallic insulation screen, copper tape or wire as metallic insulation screen, cores are assembled together with non hygroscopic polypropylene fillers and wrapped with binder tape, covered with a layer of PVC compound as bedding, steel tape armoured and PVC sheathed.
- Cables are produced according to IEC 60502.

Application

- These cables are generally suitable for direct burial or for installation on trays or in ducts.

Product Code	Nominal Cross sectional area mm ²	Max. Conductor Resistance		Capacitance µf/km	Inductance mh/km	Current Rating			Approx. Overall Diameter mm	Approx. Weight Kg/Km
		DC at 20 °C Ω/Km	AC at 90 °C Ω/Km			Ground A	Duct A	Laid in free air (Shaded) A		
3 Core - Cu/XLPE/STA/PVC										
CX5-T103-G14	50	0.387	0.4937	0.1412	0.4333	223	186	224	67.5	5550
CX5-T103-G15	70	0.268	0.3421	0.1596	0.4052	273	229	277	72	6560
CX5-T103-G16	95	0.193	0.2466	0.1711	0.3909	325	273	333	74.8	7520
CX5-T103-G17	120	0.153	0.1958	0.1844	0.3766	369	310	381	79.6	9320
CX5-T103-G18	150	0.124	0.1591	0.1976	0.3645	414	349	431	82.6	10360
CX5-T103-G19	185	0.0991	0.1276	0.2135	0.3492	465	395	489	86.7	11850
CX5-T103-G20	240	0.0754	0.0979	0.2358	0.3344	536	456	570	92.5	14100
CX5-T103-G30	300	0.0601	0.0790	0.2599	0.3219	602	515	647	98.5	16395
CX5-T103-G40	400	0.047	0.0630	0.2839	0.3110	676	582	736	104.7	19490
CX5-T103-G50	500	0.0366	0.0508	0.3151	0.2993	757	655	836	112.6	23625
3 Core - AL/XLPE/STA/PVC										
AX5-T103-G14	50	0.641	0.8220	0.1412	0.4333	173	145	174	67.5	4695
AX5-T103-G15	70	0.443	0.5682	0.1567	0.4091	212	177	215	71.3	5245
AX5-T103-G16	95	0.32	0.4106	0.1711	0.3909	253	212	259	74.8	5790
AX5-T103-G17	120	0.253	0.3248	0.1844	0.3766	288	242	297	79.6	7130
AX5-T103-G18	150	0.206	0.2647	0.1976	0.3645	322	272	335	82.6	7685
AX5-T103-G19	185	0.164	0.2110	0.2135	0.3492	364	310	382	86.7	8460
AX5-T103-G20	240	0.125	0.1613	0.2349	0.3350	421	359	447	92.2	9595
AX5-T103-G30	300	0.1	0.1297	0.2571	0.3228	475	407	509	97.8	10785
AX5-T103-G40	400	0.0778	0.1017	0.2820	0.3100	541	466	586	104.3	12335
AX5-T103-G50	500	0.0605	0.0802	0.3142	0.3005	615	532	676	112.9	14380

The above data is approximate and subjected to manufacturing tolerance
this data is applicable also for 19/33 KV

18/30 (36) KV Single Core AWA Cables

Single Core Cables, with stranded Circular copper or Aluminum conductors, XLPE insulated, aluminum wire armoured and PVC Sheath.



Description

- Stranded circular compacted copper or aluminum conductor, Semi-conducting layer as conductor screen, XLPE insulated, ,semi-conducting layer as non metallic insulation screen, copper tape or wire as metallic insulation screen, covered with a layer of PVC compound as bedding layer, aluminum wire armoured and PVC sheath.
- Cables are produced according to IEC 60502 or BS 6622.

Application

- These cables are generally suitable for direct burial or for installation on trays or in ducts.

Product Code	Nominal Cross sectional area	Max. Conductor Resistance		Capacitance	Inductance		Current Rating					Approx. Overall Diameter	Approx. Weight
		DC at 20 °C	AC at 90 °C		Trefoil	Flat	Laid in ground			Laid in free air (Shaded)			
							Flat	Trefoil	Duct	Flat Touched	Trefoil Touched		
		mm ²	Ω/Km		Ω/Km	μf/km	mh/km	A	A	A	A		
1 Core - Cu/XLPE/AWA/PVC													
CX5-T101-X14	50	0.387	0.4937	0.1412	0.4910	0.5372	237	236	202	248	250	36.2	1750
CX5-T101-X15	70	0.268	0.3420	0.1596	0.4596	0.5058	289	287	247	306	308	38.1	2040
CX5-T101-X16	95	0.193	0.2465	0.1711	0.4433	0.4895	343	340	294	369	369	39.3	2335
CX5-T101-X17	120	0.153	0.1957	0.1844	0.4270	0.4732	388	384	334	422	421	40.7	2625
CX5-T101-X18	150	0.124	0.1589	0.1976	0.4193	0.4656	431	423	373	477	470	43.5	3120
CX5-T101-X19	185	0.0991	0.1274	0.2135	0.4025	0.4488	483	469	420	541	528	45.4	3575
CX5-T101-X20	240	0.0754	0.0975	0.2358	0.3854	0.4316	553	528	483	630	608	48	4255
CX5-T101-X30	300	0.0601	0.0784	0.2599	0.3706	0.4168	616	580	542	715	679	50.8	4955
CX5-T101-X40	400	0.047	0.0623	0.2839	0.3575	0.4037	687	636	608	811	758	53.6	5900
CX5-T101-X50	500	0.0366	0.0498	0.3151	0.3432	0.3894	764	692	680	921	844	57.2	7170
CX5-T101-X60	630	0.0283	0.0402	0.3467	0.3320	0.3782	839	744	753	1033	931	61.1	8675
CX5-T101-X70	800	0.0221	0.0333	0.3864	0.3197	0.3660	912	792	825	1147	1013	65.8	10725
1 Core - AL/XLPE/AWA/PVC													
AX5-T101-X14	50	0.641	0.8219	0.1412	0.4910	0.5372	184	184	157	192	195	36.2	1465
AX5-T101-X15	70	0.443	0.5682	0.1567	0.4640	0.5102	225	224	192	238	242	37.8	1615
AX5-T101-X16	95	0.32	0.4105	0.1711	0.4433	0.4895	268	267	230	288	290	39.3	1760
AX5-T101-X17	120	0.253	0.3247	0.1844	0.4270	0.4732	304	302	262	330	332	40.7	1895
AX5-T101-X18	150	0.206	0.2646	0.1976	0.4193	0.4656	339	336	294	374	374	43.5	2225
AX5-T101-X19	185	0.164	0.2109	0.2135	0.4025	0.4488	382	378	332	427	424	45.4	2445
AX5-T101-X20	240	0.125	0.1611	0.2349	0.3861	0.4323	441	432	385	500	492	47.9	2765
AX5-T101-X30	300	0.1	0.1293	0.2571	0.3717	0.4180	494	479	434	570	555	50.5	3100
AX5-T101-X40	400	0.0778	0.1012	0.2820	0.3568	0.4030	558	534	494	656	631	53.4	3525
AX5-T101-X50	500	0.0605	0.0796	0.3142	0.3443	0.3905	630	593	562	755	716	57.3	4080
AX5-T101-X60	630	0.0469	0.0628	0.3462	0.3326	0.3788	705	651	633	861	805	61.2	4755
AX5-T101-X70	800	0.0367	0.0506	0.3900	0.3186	0.3649	783	708	709	979	898	66.2	5630

The above data is approximate and subjected to manufacturing tolerance
this data is applicable also for 19/33 KV

18/30 (36) KV Multi Core SWA Cables

Three Core Cables, with stranded circular copper or Aluminum conductors, XLPE insulated, Steel wire armoured and PVC Sheath.



Description

- Stranded circular compacted copper or aluminum conductor, Semi-conducting layer as conductor screen, XLPE insulated, semi-conducting layer as non metallic insulation screen, copper tape or wire as metallic insulation screen, cores are assembled together with non hygroscopic polypropylene fillers and wrapped with binder tape, covered with a layer of PVC compound as bedding, steel wire armoured and PVC sheathed.
- Cables are produced according to IEC 60502 or BS 6622.

Application

- These cables are generally suitable for direct burial or for installation on trays or in ducts.

Product Code	Nominal Cross sectional area	Max. Conductor Resistance		Capacitance	Inductance	Current Rating			Approx. Overall Diameter	Approx. Weight
		DC at 20 °C	AC at 90 °C			Ground	Duct	Laid in free air (Shaded)		
		mm ²	Ω/Km							
3 Core - Cu/XLPE/SWA/PVC										
CX5-T103-W14	50	0.387	0.4937	0.1412	0.4333	225	189	227	72.6	8370
CX5-T103-W15	70	0.268	0.3421	0.1596	0.4052	275	232	281	77.1	9580
CX5-T103-W16	95	0.193	0.2466	0.1711	0.3909	326	276	336	80.1	10735
CX5-T103-W17	120	0.153	0.1958	0.1844	0.3766	369	311	383	83.3	11810
CX5-T103-W18	150	0.124	0.1591	0.1976	0.3645	412	349	432	86.5	13010
CX5-T103-W19	185	0.0991	0.1276	0.2135	0.3492	462	394	489	90.6	14665
CX5-T103-W20	240	0.0754	0.0979	0.2358	0.3344	529	452	567	96.4	17115
CX5-T103-W30	300	0.0601	0.0790	0.2599	0.3219	591	508	641	102.2	19540
CX5-T103-W40	400	0.047	0.0630	0.2839	0.3110	660	569	724	108.6	22865
CX5-T103-W50	500	0.0366	0.0508	0.3151	0.2993	732	635	817	116.3	27225
3 Core - AL/XLPE/SWA/PVC										
AX5-T103-W14	50	0.641	0.8220	0.1412	0.4333	175	147	176	72.6	7515
AX5-T103-W15	70	0.443	0.5682	0.1567	0.4091	213	179	218	76.4	8275
AX5-T103-W16	95	0.32	0.4106	0.1711	0.3909	254	215	262	80.1	9005
AX5-T103-W17	120	0.253	0.3248	0.1844	0.3766	288	244	299	83.3	9620
AX5-T103-W18	150	0.206	0.2647	0.1976	0.3645	322	273	337	86.5	10335
AX5-T103-W19	185	0.164	0.2110	0.2135	0.3492	363	310	384	90.6	11275
AX5-T103-W20	240	0.125	0.1613	0.2349	0.3350	419	358	447	96.1	12550
AX5-T103-W30	300	0.1	0.1297	0.2571	0.3228	471	404	508	101.5	13885
AX5-T103-W40	400	0.0778	0.1017	0.2820	0.3100	533	460	582	108.2	15725
AX5-T103-W50	500	0.0605	0.0802	0.3142	0.3005	602	522	668	116.6	17970

The above data is approximate and subjected to manufacturing tolerance
this data is applicable also for 19/33 KV



High Voltage & Extra High Voltage Cables

Operating Voltage
(up to 500 kV)

Cable Construction

1. Conductor

Conductor Consists of stranded soft drawn copper or aluminium wires and classified into two major types:

- **Compacted Circular Conductor**
Compacted circular conductor consists of wires wounded up and then compacted
- **Segmental Compacted Conductor**
Segmental conductor consists of 5 segments and is applied for cross-section over than 1000mm² to improve A.C. resistance caused by skin effect. Swelling powder, yarns, tapes inside conductor for conductor water and humidity protection are applicable on request.
It should carry the current in normal operation, emergency and short circuit also the conductor should withstand pulling stress during cable laying

2. Conductor Screen

It consists of an extruded thermoset semi conducting compound to minimize the concentration of electric stresses at any point on the conductor due to the stranded configuration of the conductor. Semi conducting tape with or without water blocking properties can be applied over the conductor and under conductor screen.

3. Insulation

Insulation material is extruded cross-linked polyethylene which extruded over conductor screen. The thickness of the insulation layer is the maximum value figured out from the design of impulse voltage and AC voltage. The cross-linking (Curing) process by Nitrogen gas has been enabled to protect the electrical characteristic from being deteriorated.

Insulation should withstand during service life the rated voltages, lightning over voltage and switching over voltage.

4. Insulation Screen

The insulation screen is a thermoset semi-conducting compound extruded over the insulation to minimize the possibility of ionization on the outer surface of the insulation.

All the three layers (Conductor screen + Insulation + Insulation Screen) are extruded simultaneously in one process to ensure that the screen and insulation are initially bonded together and free from all possibilities of voids between layers.

This process is carried out under strict atmospheric conditions also all materials are very clean and down uploading in closed clean rooms

This process is carried out on CV lines with many measurements devices to control this process perfectly

5. Metallic Screen

It consists of copper or aluminium wires or lead alloy or some times combination of two materials to withstand the required earth fault current within the required duration

6. Outer Jacket

To protect the metallic screen and the cable from the surrounding mechanical or chemical corrosion, it could be PE(LLDPE, MDPE, HDPE) or PVC or LSOH material

7. Semiconductive Jacket (Layer)

a semi conductive layer to be applied as a graphite powder or extruded layer over the anti corrosive layer for jacket field testing after installation



26 / 45 (52) kV

Single core Copper conductor, XLPE insulated Copper wire screen and HDPE sheath (Cu/XLPE/CW/HDPE)



Description

- Stranded circular or segmental compacted copper conductor, semi-conducting layer as conductor screen, XLPE insulated, semi-conducting layer as non metallic insulation screen, Semi-conductive water blocking tape, copper wire as metallic insulation screen to withstand the required earth fault current, non-conductive water blocking tape to protect the screen area from longitudinal water penetration, copolymer aluminum tape to protect the cable from radial water penetration and HDPE sheathed with graphite coating or extruded semi-conducting layer.
- Cables are designed and tested to comply with IEC 60228, 60840 and 60811.

Constructional data (Nominal Values)

Product Code	Conductor			Thickness of Conductor Screen	Thickness of insulation	Thickness of insulation Screen	No. of wires X Wire dia.	Thickness of outer sheath	Approx. outer diameter of cable	Approx. weight of cable	Max. DC conductor resistance at 20 °C	Capacitance
	Nominal Cross sectional area	Shape	Approx. diameter Screen									
	mm ²		mm									
CXG-TX01-K17		Compact round standard	12.7	0.6	9	0.6	59 X 1.04	2	42.2	2600	0.153	0.169
CXG-TX01-K18	120		14.1	0.6	9	0.6	59 X 1.04	2	43.6	2900	0.1240	0.180
CXG-TX01-K19	185		15.8	0.6	9	0.6	59 X 1.04	2.1	45.5	3300	0.0991	0.194
CXG-TX01-K20	240		18.2	0.6	9	0.6	59 X 1.04	2.1	47.9	3900	0.0754	0.213
CXG-TX01-K30	300		20.6	0.6	9	0.6	59 X 1.04	2.2	50.5	4600	0.0601	0.232
CXG-TX01-K40	400		23.2	0.6	9	0.6	59 X 1.04	2.3	53.3	5500	0.0470	0.253
CXG-TX01-K50	500		26.6	0.6	9	0.6	59 X 1.04	2.4	56.9	6600	0.0366	0.280
CXG-TX01-K60	630		30.1	0.6	9	0.6	59 X 1.04	2.5	60.6	8000	0.0283	0.307
CXG-TX01-K70	800		34.5	0.6	9		59 X 1.04	2.7	65.4	9900	0.0221	0.342
CXG-TX01-K80	1000		40	1.2	9	0.6	59 X 1.04	3.5	80.6	13280	0.0176	0.398
CXG-TX01-K81	1200	Segment standard (Miliken)	42.5	1.2	9	1	59 X 1.04	3.5	84.5	15300	0.0151	0.417
CXG-TX01-K83	1600		50.5	1.2	9	1	59 X 1.04	4	91.3	19680	0.0113	0.480
CXG-TX01-K85	2000		55.5	1.4	9	1	59 X 1.04	4	98.1	23050	0.0090	0.524
CXG-TX01-K86	2500		62	1.4	9	1	59 X 1.04	4.5	103.6	28580	0.0072	0.574

continuous current ratings (load factor = 100%) for one circuit in operation (Amperes)

Laying conditions: Trefoil formation				Laying conditions: Flat formation			
Type Of Earthing Bonding System	Nominal Cross sectional area	Direct burial	In air (Shaded)	Type Of Earthing Bonding System	Nominal Cross sectional area	Direct burial	In air (Shaded)
		p_i , in °C cm/W	$T = 30$ °C			p_i , in °C cm/W	$T = 30$ °C
Bonding at both ends	120 R	366	426	Cross or Single point bonding	120 R	427	495
	150 R	409	482		150 R	479	563
	185 R	461	550		185 R	542	646
	240 R	531	647		240 R	629	765
	300 R	596	739		300 R	712	881
	400 R	673	849		400 R	811	1023
	500 R	757	977		500 R	925	1192
Cross or Single point bonding	630 R	895	1167		630 R	1053	1384
	800 R	1000	1332		800 R	1186	1597
	1000 S	1204	1643		1000 S	1382	1916
	1200 S	1298	1788		1200 S	1493	2095
	1600 S	1490	2116		1600 S	1726	2505
	2000 S	1639	2366		2000 S	1913	2828
	2500 S	1788	2631		2500 S	2103	3181

Note: Copper wires cross section area and dimensions are based on the required earth fault current.

R: Round conductor
S: Segmental Conductor

38/66 (72.5) KV

**Single core Copper conductor, XLPE insulated
Copper wire screen and HDPE sheath
(Cu/XLPE/CW/HDPE).**



Description

- Stranded circular or segmental compacted copper conductor, semi-conducting layer as conductor screen, XLPE insulated, semi-conducting layer as non metallic insulation screen, Semi-conductive water blocking tape, copper wire as metallic insulation screen to withstand the required earth fault current, non-conductive water blocking tape to protect the screen area from longitudinal water penetration, copolymer aluminum tape to protect the cable from radial water penetration and HDPE sheathed with graphite coating or extruded semi-conducting layer.
- Cables are designed and tested to comply with IEC 60228, 60840 and 60811.

Constructional data (Nominal Values)

Product Code	Conductor			Thickness of Conductor Screen	Thickness of insulation	Thickness of insulation Screen	No. of wires X Wire dia.	Thickness of outer sheath	Approx. outer diameter of cable	Approx. weight of cable	Max. DC conductor resistance at 20 °C	Capacitance
	Nominal Cross sectional area	Shape	Approx. diameter Screen									
	mm ²		mm									
CX6-TX01-K18	150	Compact round standard	14.1	1	10	1	50 x 1.43	3.5	50.8	3650	0.1240	0.173
CX6-TX01-K19	185		15.8	1	10	1	50 x 1.43	3.5	52.7	4075	0.0991	0.186
CX6-TX01-K20	240		18.2	1	10	1	50 x 1.43	3.5	55.1	4700	0.0754	0.203
CX6-TX01-K30	300		20.6	1	10	1	50 x 1.43	3.5	57.5	5400	0.0601	0.221
CX6-TX01-K40	400		23.2	1	10	1	50 x 1.43	3.5	60.1	6260	0.0470	0.239
CX6-TX01-K50	500		26.6	1	10	1	50 x 1.43	4	64.5	7570	0.0366	0.263
CX6-TX01-K60	630		30.1	1	10	1	50 x 1.43	4	68.0	8910	0.0283	0.288
CX6-TX01-K70	800	34.4	1	10	1	50 x 1.43	4	72.3	10900	0.0221	0.319	
CX6-TX01-K80	1000	Segment standard (Miliken)	40	1.5	10	1.2	50 x 1.43	4	80.6	13280	0.0176	0.371
CX6-TX01-K81	1200		43.7	1.5	10	1.2	50 x 1.43	4.5	84.5	15300	0.0151	0.397
CX6-TX01-K83	1600		50.5	1.5	10	1.2	50 x 1.43	4.5	91.3	19680	0.0113	0.444
CX6-TX01-K85	2000		56.5	1.5	10	1.2	50 x 1.43	4.5	98.1	23050	0.0090	0.486
CX6-TX01-K86	2500		62	1.5	10	1.2	50 x 1.43	4.5	103.6	28580	0.0072	0.525

continuous current ratings (load factor = 100%) for one circuit in operation (Amperes)

Laying conditions: Trefoil formation				Laying conditions: Flat formation			
Type Of Earthing Bonding System	Nominal Cross sectional area	Direct burial	In air (Shaded)	Type Of Earthing Bonding System	Nominal Cross sectional area	Direct burial	In air (Shaded)
		p_1 , in °C cm/W	$T = 30$ °C			p_1 , in °C cm/W	$T = 30$ °C
Bonding at both ends	150	407	485	Cross or Single point bonding	150 R	473	561
	185	458	553		185 R	536	644
	240	526	648		240 R	623	762
	300	589	738		300 R	705	877
	400	662	846		400 R	804	1018
	500	744	968		500 R	916	1183
Cross or Single point bonding	630 R	902	1178		630 R	1043	1373
	800 R	1009	1344		800 R	1176	1584
	1000 S	1212	1653		1000 S	1377	1913
	1200 S	1309	1811		1200 S	1493	2102
	1600 S	1502	2129		1600 S	1720	2499
	2000 S	1656	2395		2000 S	1913	2845
	2500 S	1803	2653	2500 S	2103	3192	

Note: Copper wires cross section area and dimensions are based on the required earth fault current.

R: Round conductor
S: Segmental Conductor

38/66 (72.5) KV

Single core Copper conductor, XLPE insulated Lead Sheathed and HDPE sheath (Cu/XLPE/Lead/HDPE).



Description

- Stranded circular or segmental compacted copper conductor, semi-conducting layer as conductor screen, XLPE insulated, semi-conducting layer as non metallic insulation screen, semi conductive water blocking tape to protect the screen area from longitudinal water penetration, lead sheathed with suitable thickness to withstand the required earth fault current and HDPE sheathed with graphite coating or extruded semi-conducting layer.
- Cables are designed and tested to comply with IEC 60228, 60840 and 60811.

Constructional data (Nominal Values)

Product Code	Conductor			Thickness of Conductor Screen	Thickness of insulation	Thickness of insulation Screen	Thickness of Lead Sheath	Thickness of outer sheath	Approx. outer diameter of cable	Approx. weight of cable	Max. DC conductor resistance at 20 °C	Capacitance
	Nominal Cross sectional area	Shape	Approx. diameter Screen									
	mm ²		mm	mm	mm	mm	mm	mm	mm	Kg/Km	Ω/Km	µf/km
CX6-TX01-N18	150	Compact round standard	14.1	1	10	1	2.0	3.5	50.3	5720	0.1240	0.173
CX6-TX01-N19	185		15.8	1	10	1	2.0	3.5	52	6260	0.0991	0.186
CX6-TX01-N20	240		18.2	1	10	1	2.1	3.5	54.6	7220	0.0754	0.203
CX6-TX01-N30	300		20.6	1	10	1	2.2	3.5	57.2	8270	0.0601	0.221
CX6-TX01-N40	400		23.2	1	10	1	2.3	3.5	60	9520	0.0470	0.239
CX6-TX01-N50	500		26.6	1	10	1	2.4	4	64.6	11300	0.0366	0.263
CX6-TX01-N60	630		30.1	1	10	1	2.4	4	68.1	13190	0.0283	0.288
CX6-TX01-N70	800	34.4	1	10	1	2.6	4	72.8	15730	0.0221	0.319	
CX6-TX01-N80	1000	Segment standard (Miliken)	40	1.5	10	1.2	2.7	4	80.6	19220	0.0176	0.371
CX6-TX01-N81	1200		43.7	1.5	10	1.2	2.8	4.5	85.5	21690	0.0151	0.397
CX6-TX01-N83	1600		50.5	1.5	10	1.2	3.0	4.5	92.7	27490	0.0113	0.444
CX6-TX01-N85	2000		56.5	1.5	10	1.2	3.2	4.5	99.1	32140	0.0090	0.486
CX6-TX01-N86	2500		62	1.5	10	1.2	3.4	4.5	105	39110	0.0072	0.525

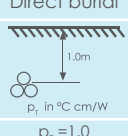
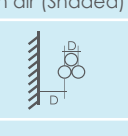
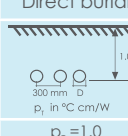
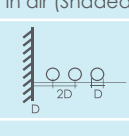
continuous current ratings (load factor = 100%) for one circuit in operation (Amperes)							
Laying conditions: Trefoil formation				Laying conditions: Flat formation			
Type Of Earthing Bonding System	Nominal Cross sectional area	Direct burial	In air (Shaded)	Type Of Earthing Bonding System	Nominal Cross sectional area	Direct burial	In air (Shaded)
		 p_1 in °C cm/W	 T = 30 °C			 p_1 in °C cm/W	 T = 30 °C
	mm ²	$p_1 = 1.0$ T = 20 °C			mm	$p_1 = 1.0$ T = 20 °C	
Bonding at both ends	150 R	414	495	Cross or Single point bonding	150 R	475	564
	185 R	468	565		185 R	537	647
	240 R	540	664		240 R	624	765
	300 R	609	760		300 R	707	882
	400 R	687	874		400 R	806	1023
	500 R	773	1005		500 R	919	1190
	630 R	899	1182		630 R	1046	1380
Cross or Single point bonding	800 R	1001	1346		800 R	1180	1592
	1000 S	1191	1642		1000 S	1380	1917
	1200 S	1282	1793		1200 S	1493	2103
	1600 S	1451	2088		1600 S	1722	2491
	2000 S	1573	2318		2000 S	1912	2823
	2500 S	1684	2535		2500 S	2079	3149

Note:
Lead Alloy thickness is based on the required earth fault current.

R: Round conductor
S: Segmental Conductor

76/132 (145) KV

Single core Copper conductor, XLPE insulated Copper wire screen and HDPE sheath (Cu/XLPE/CW/HDPE).



Description

- Stranded circular or segmental compacted copper conductor, semi-conducting layer as conductor screen, XLPE insulated, semi-conducting layer as non metallic insulation screen, Semi-conductive water blocking tape, copper wire as metallic insulation screen to withstand the required earth fault current, non-conductive water blocking tape to protect the screen area from longitudinal water penetration, copolymer aluminum tape to protect the cable from radial water penetration and HDPE sheathed with graphite coating or extruded semi-conducting layer.
- Cables are designed and tested to comply with IEC 60228, 60840 and 60811.

Constructional data (Nominal Values)

Product Code	Conductor			Thickness of Conductor Screen	Thickness of insulation	Thickness of insulation Screen	No. of wires X Wire dia.	Thickness of outer sheath	Approx. outer diameter of cable	Approx. weight of cable	Max. DC conductor resistance at 20 °C	Capacitance
	Nominal Cross sectional area	Shape	Approx. diameter Screen									
	mm ²		mm									
CX7-TX01-K20	240	Compact round standard	18.2	1.2	16	1	75 x 1.75	4.5	70.1	6960	0.0754	0.149
CX7-TX01-K30	300		20.6	1.2	16	1	75 x 1.75	4.5	72.5	7710	0.0601	0.160
CX7-TX01-K40	400		23.2	1.2	16	1	75 x 1.75	4.5	75.1	8640	0.0470	0.172
CX7-TX01-K50	500		26.6	1.2	16	1	75 x 1.75	4.5	78.5	9920	0.0366	0.188
CX7-TX01-K60	630		30	1.2	16	1	75 x 1.75	4.5	82	11380	0.0283	0.204
CX7-TX01-K70	800		34.4	1.2	16	1	75 x 1.75	4.5	86.3	13400	0.0221	0.223
CX7-TX01-K80	1000	Segment standard (Miliken)	40	1.5	16	1.2	75 x 1.75	4.5	95.2	15920	0.0176	0.261
CX7-TX01-K81	1200		43.7	1.5	16	1.2	75 x 1.75	4.5	97.1	17840	0.0151	0.269
CX7-TX01-K83	1600		50.5	1.5	16	1.2	75 x 1.75	4.5	105.5	22380	0.0113	0.306
CX7-TX01-K85	2000		56.5	1.5	16	1.2	75 x 1.75	4.5	110.5	26450	0.0090	0.328
CX7-TX01-K86	2500		62	1.5	16	1.2	75 x 1.75	4.5	116.8	31365	0.0072	0.356

continuous current ratings (load factor = 100%) for one circuit in operation (Amperes)							
Laying conditions: Trefoil formation				Laying conditions: Flat formation			
Type Of Earthing Bonding System	Nominal Cross sectional area	Direct burial	In air (Shaded)	Type Of Earthing Bonding System	Nominal Cross sectional area	Direct burial	In air (Shaded)
		mm ²	$p_1 = 1.0$ T = 20 °C			T = 30 °C	mm
Bonding at both ends	240 R	509	635	Cross or Single point bonding	240 R	606	739
	300 R	567	720		300 R	687	850
	400 R	634	820		400 R	784	985
	500 R	706	933		500 R	896	1146
	630 R	904	1173		630 R	1021	1331
Cross or Single point bonding	800 R	1013	1339		800 R	1153	1534
	1000 S	1214	1642		1000 S	1357	1858
	1200 S	1311	1789		1200 S	1467	2033
	1600 S	1512	2121		1600 S	1703	2437
	2000 S	1666	2375		2000 S	1892	2756
	2500 S	1824	2645	2500 S	2085	3103	

Note: Copper wires cross section area and dimensions are based on the required earth fault current.

R: Round conductor
S: Segmental Conductor

76/132 (145) KV

Single core Copper conductor, XLPE insulated Lead Sheathed and HDPE sheath (Cu/XLPE/Lead/HDPE).



Description

- Stranded circular or segmental compacted copper conductor, semi-conducting layer as conductor screen, XLPE insulated, semi-conducting layer as non metallic insulation screen, semi conductive water blocking tape to protect the screen area from longitudinal water penetration, lead sheathed with suitable thickness to withstand the required earth fault current and HDPE sheathed with graphite coating or extruded semi-conducting layer.
- Cables are designed and tested to comply with IEC 60228, 60840 and 60811.

Constructional data (Nominal Values)

Product Code	Conductor			Thickness of Conductor Screen	Thickness of insulation	Thickness of insulation Screen	Thickness of Lead Sheath	Thickness of outer sheath	Approx. outer diameter of cable	Approx. weight of cable	Max. DC conductor resistance at 20 °C	Capacitance
	Nominal Cross sectional area	Shape	Approx. diameter Screen									
	mm ²		mm									
CX7-TX01-N20	240	Compact round standard	18.2	1.2	16	1	2.4	4.5	69.6	10050	0.0754	0.149
CX7-TX01-N30	300		20.6	1.2	16	1	2.5	4.5	72.2	11220	0.0601	0.160
CX7-TX01-N40	400		23.2	1.2	16	1	2.6	4.5	75	12600	0.0470	0.172
CX7-TX01-N50	500		26.6	1.2	16	1	2.7	4.5	78.6	14450	0.0366	0.188
CX7-TX01-N60	630		30.1	1.2	16	1	2.7	4.5	82.5	16490	0.0283	0.204
CX7-TX01-N70	800		34.4	1.2	16	1	2.9	4.5	86.8	19200	0.0221	0.223
CX7-TX01-N80	1000	Segment standard (Miliken)	40	1.5	16	1.2	3.0	4.5	98.1	24960	0.0176	0.261
CX7-TX01-N81	1200		43.7	1.5	16	1.2	3.1	4.5	100.5	25360	0.0151	0.269
CX7-TX01-N83	1600		50.5	1.5	16	1.2	3.3	4.5	106.8	31480	0.0113	0.306
CX7-TX01-N85	2000		56.5	1.5	16	1.2	3.5	4.5	112.2	36860	0.0090	0.328
CX7-TX01-N86	2500		62	1.5	16	1.2	3.7	4.5	119.9	43200	0.0072	0.356

continuous current ratings (load factor = 100%) for one circuit in operation (Amperes)

Laying conditions: Trefoil formation				Laying conditions: Flat formation			
Type Of Earthing Bonding System	Nominal Cross sectional area	Direct burial	In air (Shaded)	Type Of Earthing Bonding System	Nominal Cross sectional area	Direct burial	In air (Shaded)
		$p_1 = 1.0$ $T = 20\text{ }^\circ\text{C}$	$T = 30\text{ }^\circ\text{C}$			$p_1 = 1.0$ $T = 20\text{ }^\circ\text{C}$	$T = 30\text{ }^\circ\text{C}$
Bonding at both ends	240 R	536	661	Cross or Single point bonding	240 R	607	741
	300 R	603	754		300 R	687	853
	400 R	682	866		400 R	784	988
	500 R	767	995		500 R	896	1150
	630 R	896	1170		630 R	1021	1334
Cross or Single point bonding	800 R	1000	1333		800 R	1151	1538
	1000 S	1185	1621		1000 S	1352	1858
	1200 S	1271	1756		1200 S	1459	2029
	1600 S	1437	2057		1600 S	1683	2418
	2000 S	1559	2276		2000 S	1857	2716
	2500 S	1670	2497	2500 S	2026	3027	

Note:
Lead Alloy thickness is based on the required earth fault current.

R: Round conductor
S: Segmental Conductor

127/220 (245) KV

**Single core Copper conductor, XLPE insulated
Copper wire screen and HDPE sheath
(Cu/XLPE/CW/HDPE).**



Description

- Stranded circular or segmental compacted copper conductor, semi-conducting layer as conductor screen, XLPE insulated, semi-conducting layer as non metallic insulation screen, Semi-conductive water blocking tape, copper wire as metallic insulation screen to withstand the required earth fault current, non-conductive water blocking tape to protect the screen area from longitudinal water penetration, copolymer aluminum tape to protect the cable from radial water penetration and HDPE sheathed with graphite coating or extruded semi-conducting layer.
- Cables are designed and tested to comply with IEC 60228, 62067 and 60811.

Constructional data (Nominal Values)

Product Code	Conductor			Thickness of Conductor Screen	Thickness of insulation	Thickness of insulation Screen	Thickness of Lead Sheath	Thickness of outer sheath	Approx. outer diameter of cable	Approx. weight of cable	Max. DC conductor resistance at 20 °C	Capacitance
	Nominal Cross sectional area	Shape	Approx. diameter Screen									
	mm ²		mm	mm	mm	mm	mm	mm	Kg/Km	Ω/Km	µf/km	
CX8-TX01-K40	400	Compact round standard	23.2	1.5	23	1.5	75 x 1.75	4.5	90.6	10520	0.0470	0.138
CX8-TX01-K50	500		26.6	1.5	23	1.5	75 x 1.75	4.5	94.1	11870	0.0366	0.149
CX8-TX01-K60	630		30	1.5	23	1.5	75 x 1.75	4.5	97.6	13410	0.0283	0.160
CX8-TX01-K70	800		34.4	1.5	23	1.5	75 x 1.75	4.5	101.9	15530	0.0221	0.174
CX8-TX01-K80	1000	Segment standard (Miliken)	40	1.5	23	1.5	75 x 1.75	5	110.8	18250	0.0176	0.199
CX8-TX01-K81	1200		43.7	1.5	23	1.5	75 x 1.75	5	112.7	20220	0.0151	0.205
CX8-TX01-K83	1600		50.5	1.5	23	1.5	75 x 1.75	5	121.1	24940	0.0113	0.231
CX8-TX01-K85	2000		56.5	1.5	23	1.5	75 x 1.75	5	126.1	28870	0.0090	0.247
CX8-TX01-K86	2500		62	1.5	23	1.5	75 x 1.75	5	132.4	34785	0.0072	0.266

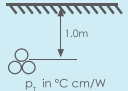
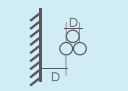
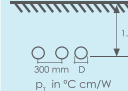
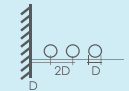
continuous current ratings (load factor = 100%) for one circuit in operation (Amperes)							
Laying conditions: Trefoil formation				Laying conditions: Flat formation			
Type Of Earthing Bonding System	Nominal Cross sectional area	Direct burial	In air (Shaded)	Type Of Earthing Bonding System	Nominal Cross sectional area	Direct burial	In air (Shaded)
		 p _i in °C cm/W	 T = 30 °C			 p _i in °C cm/W	 T = 30 °C
	mm ²	p _i = 1.0 T = 20 °C			mm	p _i = 1.0 T = 20 °C	
Bonding at both ends	400 R	633	818	Cross or Single point bonding	400 R	761	949
	500 R	707	933		500 R	869	1103
	630 R	894	1152		630 R	991	1278
	800 R	1004	1315		800 R	1118	1471
Cross or Single point bonding	1000 S	1196	1602		1000 S	1317	1779
	1200 S	1292	1745		1200 S	1424	1943
	1600 S	1492	2069		1600 S	1652	2324
	2000 S	1648	2319		2000 S	1835	2624
	2500 S	1806	2584		2500 S	2022	2949

Note: Copper wires cross section area and dimensions are based on the required earth fault current.

R: Round conductor
S: Segmental Conductor

127/220 (245) KV

Single core Copper conductor, XLPE insulated Lead Sheathed and HDPE sheath (Cu/XLPE/Lead/HDPE).



Description

- Stranded circular or segmental compacted copper conductor, semi-conducting layer as conductor screen, XLPE insulated, semi-conducting layer as non metallic insulation screen, semi conductive water blocking tape to protect the screen area from longitudinal water penetration, lead sheathed with suitable thickness to withstand the required earth fault current and HDPE sheathed with graphite coating or extruded semi-conducting layer.
- Cables are designed and tested to comply with IEC 60228, 62067 and 60811.

Constructional data (Nominal Values)

Product Code	Conductor			Thickness of Conductor Screen	Thickness of insulation	Thickness of insulation Screen	Thickness of Lead Sheath	Thickness of outer sheath	Approx. outer diameter of cable	Approx. weight of cable	Max. DC conductor resistance at 20 °C	Capacitance
	Nominal Cross sectional area	Shape	Approx. diameter Screen									
	mm ²		mm	mm	mm	mm	mm	mm	mm	Kg/Km	Ω/Km	µf/km
CX8-TX01-N40	400	Compact round standard	23.2	1.5	23	1.5	3.2	4.5	91.8	17330	0.0470	0.138
CX8-TX01-N50	500		26.6	1.5	23	1.5	3.3	4.5	95.4	19370	0.0366	0.149
CX8-TX01-N60	630		30.1	1.5	23	1.5	3.4	4.5	99.1	21620	0.0283	0.160
CX8-TX01-N70	800		34.4	1.5	23	1.5	3.5	4.5	103.6	24570	0.0221	0.174
CX8-TX01-N80	1000	Segment standard (Miliken)	40	1.5	23	1.5	3.6	5	112.9	29330	0.0176	0.199
CX8-TX01-N81	1200		43.7	1.5	23	1.5	3.9	5	115.2	32290	0.0151	0.205
CX8-TX01-N83	1600		50.5	1.5	23	1.5	4.1	5	123.8	38560	0.0113	0.231
CX8-TX01-N85	2000		56.5	1.5	23	1.5	4.2	5	129.4	43950	0.0090	0.247
CX8-TX01-N86	2500		62	1.5	23	1.5	4.4	5	136.9	49865	0.0072	0.266

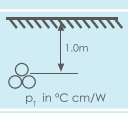
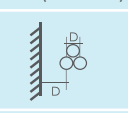
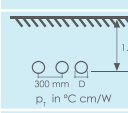
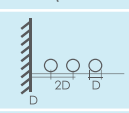
continuous current ratings (load factor = 100%) for one circuit in operation (Amperes)							
Laying conditions: Trefoil formation				Laying conditions: Flat formation			
Type Of Earthing Bonding System	Nominal Cross sectional area	Direct burial	In air (Shaded)	Type Of Earthing Bonding System	Nominal Cross sectional area	Direct burial	In air (Shaded)
		 p _r in °C cm/W	 T = 30 °C			 p _r in °C cm/W	 T = 30 °C
	mm ²	p _r = 1.0 T = 20 °C	T = 30 °C		mm	p _r = 1.0 T = 20 °C	T = 30 °C
Bonding at both ends	400 R	666	848	Cross or Single point bonding	400 R	761	953
	500 R	749	972		500 R	869	1106
	630 R	881	1146		630 R	989	1281
	800 R	983	1304		800 R	1114	1471
Cross or Single point bonding	1000 S	1154	1573		1000 S	1306	1772
	1200 S	1234	1703		1200 S	1407	1931
	1600 S	1393	1989		1600 S	1615	2288
	2000 S	1510	2200		2000 S	1776	2559
	2500 S	1613	2412		2500 S	1926	2882

Note:
Lead Alloy thickness is based on the required earth fault current.

R: Round conductor
S: Segmental Conductor

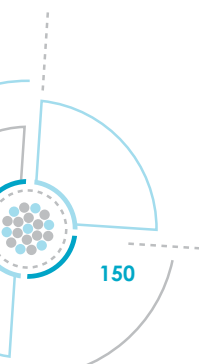



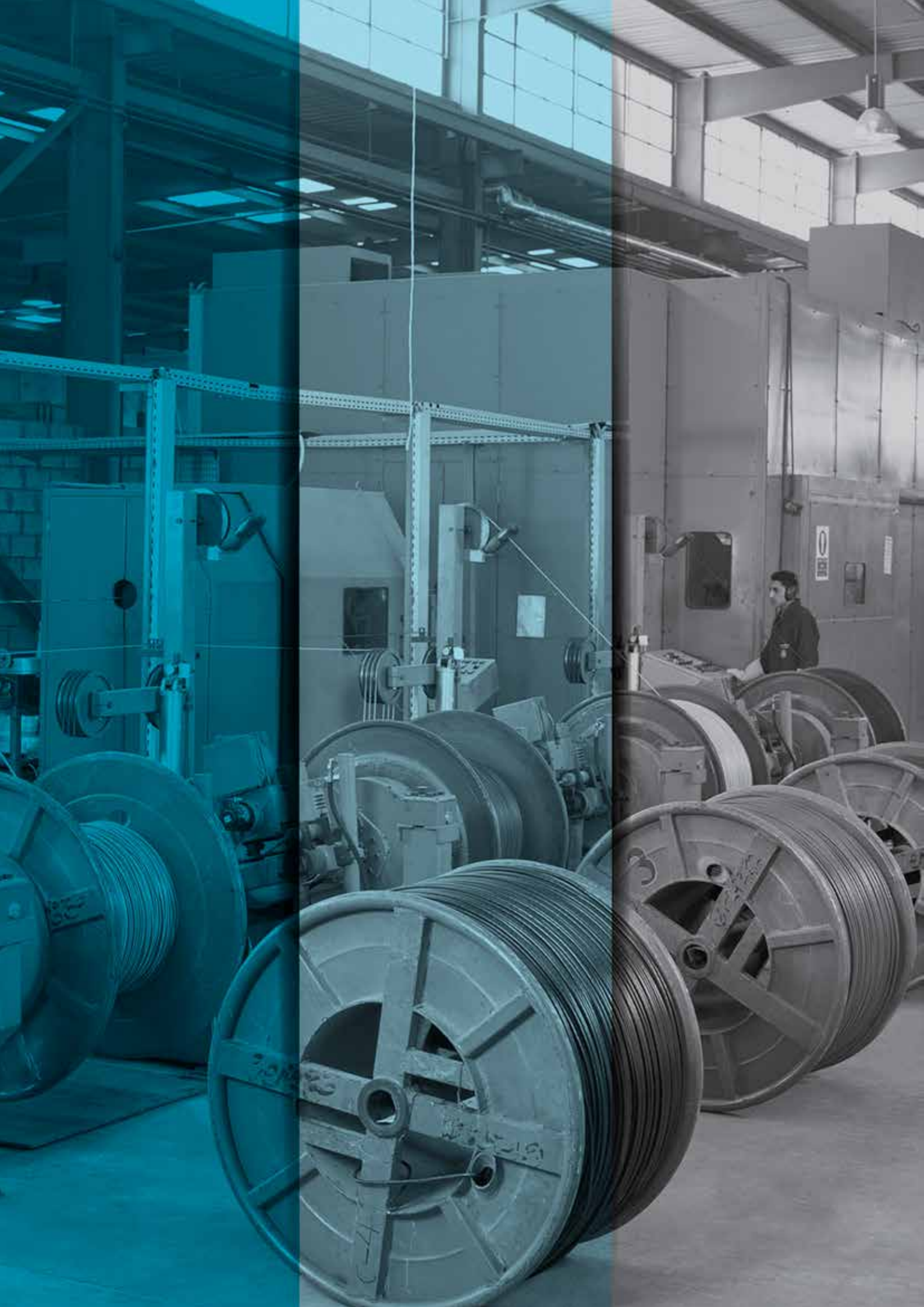

Handling & Laying Instructions

Cables should be installed and stored according to international regulation by trained persons with good engineering practice. Cables are supplied on heavy wooden/steel drum and handling these drums can constitute real hazardous. The below instructions provide the guidelines and procedures which should be applied to secure the cable drums from damages and any consequence losses.

Handling Instructions

1. Upright position

All the drums should be handled and stored standing upright, no drums should be handled or stored in flat position under any circumstances. This will lead to cable damage and may cause Problems during laying.

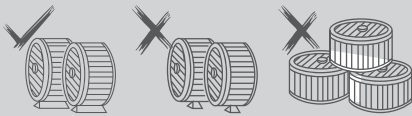

2. Rolling Direction

- 2.1. If the drum is required to be rolled, it should be rolled in the direction of the printed arrow on the outer flange. This direction will remain the cable safe and tight.
- 2.2. Drums should be rolled only for short distance over flat solid ground in the direction indicated by the arrow on the flange.
- 2.3. Suitable stoppers should be used to make sure that the drum is not able to move after being placed in its position.
- 2.4. Wooden lagging of the drum should be kept safe without any stresses.
- 2.5. When moving the drums by hand, the operators should wear stout gloves and safety footwear



3. Lifting the drum

- 3.1. When lifting drums by crane, spreader beam should be used.
- 3.2. On lowering the drum be sure that the drum moves as slow as possible and prevent it from any hard impact with the ground.
- 3.3. The drum axis should be kept always in a horizontal position.



4. Fork lift handling

- 4.1. When lifting drums by fork lift trucks, the cable drum flanges should be at right angles to the forks, and the forks should be longer than the width of the drum (see below figure).
- 4.2. Before moving the lift. Be sure that the lift raised the drum to a sufficient space above the ground.
- 4.3. Be sure that the truck has stopped completely before releasing the drum.
- 4.4. Always refer to the relevant schedules for dimensions and weights of each cable drums.
- 4.5. Cable drums must be laid perpendicular to the direction of the moving vehicle.
- 4.6. Under no circumstances should the fork come in a contact with the cable.



5. Securing the drums

- 5.1. The drums should be secured by the suitable edges to safely park the drum.
- 5.2 longitudinal heavy gauge metal strips binding in two places on every drum. (If necessary)

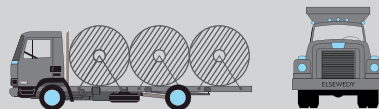

6. Transporting the drums

Each drum should have a separate tight, suitable wires should be used to prevent the motion of the drums during transportation.

7. Long period's storage

- 7.1. Store the drums on a flat and dry area, prevent any roughness, this will lead to drum damages.
- 7.2. Sufficient spaces should be kept between drums.
- 7.3. Sufficient spaces should be rolled to an angle of 90 periodically .Bolts must be checked.

- 7.4. Avoid storing the drums in direct sunlight for long periods. Suitable covering shall be used if the drums must be stored in direct sunlight
- 7.5. Cable drums have to be stored whenever possible away from vehicular traffic in order to minimize the risk of being accidentally damaged.
- 7.6 In case of all above conditions are achieved we recommend the period length should be one year

8. Unwinding and Rewinding

- 8.1. Unwinding and rewinding of cables should be performed as shown in the following figures.

Unwinding:

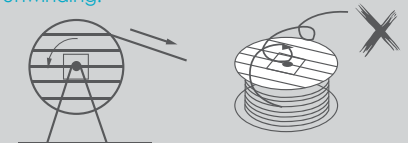

Rewinding:

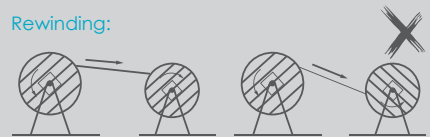

- 8.2. When cable rewinding is required, the same drum diameter or greater should be used.
- 8.3. During cable rewinding, avoid any sharp edges that may damage the cable.
- 8.4. Maximum cable pulling force and bending radius should be considered.
- 8.5. Wooden drums have an arrow marked on their flanges indicate both, the direction that cables is to be wound on to them and also the direction in which the drum is to be rolled.

Note: cable handling and storage procedures is according to BS 8512

Laying of Power Cables

Applied Laying Depth

Type of Cable	Type of Cable
L.V	50 - 80
M.V	80 - 100
H.V	100 - 120
E.H.V	120 - 140

- Cable laying is a major factor affecting the cable life.
- Our Catalogue based on 50 cm for L.V & M.V and 100 cm for H.V & E.H.V

Laying Methods

1- Preparation for the cable

1. The cable should, wherever, be de-coiled from the top of the drum. For this the drum must be positioned such that the arrow on the drum points opposite to the direction of rotation for de-coiling. The drum is lifted on its axle by the aid of winches such that the plank used for braking cannot become wedged beneath.
2. The cable must be inspected for external damage which, e.g. may have been incurred by incorrect rolling of the drum. Since the laying of cables is often carried out by unskilled labor it is necessary to emphasize that the cable is a highvalue commodity and is very sensitive to damage and must be handled with the necessary care.
3. In order to avoid damage to the corrosion protection and the insulation. the cables must not be dragged over sharp objects and must not be bent too sharply (see Table 1).
4. It must be possible to brake the drum at any time in order to avoid. in the event of a sudden stoppage, continuation of decoiling which would result in sharp bending of the cable . Avoidance of kinking is especially critical under all circumstances.
5. Cables must be heated prior to laying where the cable temperature is below (- 5°C) for polymer insulated cables, otherwise the insulation and corrosion protection will be damage during bending. These values apply to the cables themselves and not to the ambient temperature. either the drums must be stored for several days in a heated building or heaters or hot air blowers applied at a sufficient distance. During this warming process the drums should be rotated at intervals.
6. To avoid ingress of moisture it must be observed that the end capping of the cable is not damaged. Cut points of cables must be immediately capped.

Table 1
Minimum permissible bending radii (r) when laying cables

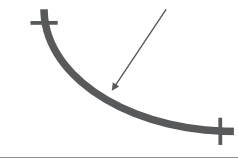
	Polymer insulated cables
Over UO/U = 1.9/3.3kV	
• PE or LSHF jacket	20 X D
• Lead unarmored	18 X D
• Lead armored	15 X D
• PVC jacket	15 X D
Up to UO/U = 1.9/3.3kV	
• PE or LSHF jacket	20 X D
• Lead unarmored	18 X D
• Lead armored	15 X D
• PVC jacket single core or multi armored wire or unarmored	8 X D
• PVC jacket single core or multi armored tape or shield tape	15 X D

d: outer diameter of the cable
Where a bend is to be made once only as for example immediately before a sealing end then, providing proper procedures are carried out (heating to 30 °C and bending over a form tool), the values of r can be reduced to 50% of those above .

2- Laying of Cables in the Ground

2.1 Cable Route

1. For the progression of a cable route in built-up areas it is most suitable to use a paved pedestrian area or in overland routes to follow a foot path. The depth of trench is dependent on the number of cable to be laid above one another in the same trench, furthermore in urban areas and on industrial sites it also depends on any gas or water pipes which exist or may be laid in the future.
2. The cable laying uppermost below a paved pedestrian area or foot path should be at a depth not less than 0.6m and below roads at a depth of not less than 0.8m. Where cable are laid at shallower depths they must be protected by e.g. concrete slabs of sufficient thickness.
3. The cables are normally covered with a layer of sand or stone-free (sieved) soil 10 cm thick and then, to protect against surface damage during subsequent earth workings, are covered with bricks, plastic plates or similar devices. If covers are not provided warning tapes of plastic are normally used to mark the cable route.
4. Where high-voltage and low-voltage cables are laid in the same trench, it is the practice to lay the high-voltage cable in the lowest position. The high-voltage cable are then embedded in sand and covered by protective slabs. Above these on an additional layer of sand the low-voltage cables are laid. In such a cable arrangement the current load capacity, because of the mutual heating effect and drying out of the soil, is reduced .
5. If control cables and high-voltage cables run on parallel routes for any great distance the magnitude of interference must be investigated. The same applies where the route is in close proximity to or crosses railway installations or communication networks of the post office.

2.2 Crossing of Roads

1. When the route crosses a roadway the cables must be drawn into pipes or cable duct blocks which extend beyond and under the pavements.
2. It is advisable always to provide reserve space in pipes or pipe ducts to avoid the necessity to reexcavate when adding cable at a later date. Pipe cavities which are not occupied immediately should be sealed off.
3. The pipe bore should have a diameter of at least 1.5 times the outer diameter d of the cable. Pipe bends should, in respect of pulling the cable through, have a minimum radius corresponding to those shown in table 2.0 where for the value of d the pipe outer diameter should be used.

Table 2
Minimum permissible bending radii (r) for pipes

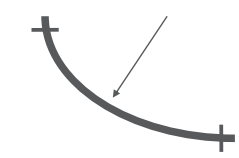
	PVC Pipes	PE Pipes
Based on DR factor		
• 9 or less	200 X D	20 X D
• 11, 13.5	250 X D	25 X D
• 17, 21	270 X D	27 X D
• 26	340 X D	34 X D

DR: dimension ratio: average outer diameter divided by minimum wall thickness

3- Cable Laying Methods

The following methods may be employed for laying cables:

- Paying out from a cable trailer
- Laying by hand
- Laying by motor driven rollers
- Pulling off by winches
- Ploughing in.

3.1 Paying out from a Cable Trailer

Providing there are no obstructions in the trench or its vicinity, cable may be paid out direct from the cable trailer. However it must be ensured that during the paying out the drum is manually rotated and braked in accordance with the laying speed to avoid hightensile force or sharp bending of the cable.

3.2 Laying by Hand

Cable rollers placed at distances of between 3 to 4m make laying easier. Corner rollers or similar devices should be provided at any bend in the route, always maintaining the minimum bending radii of the cable .

If the cable is not guided by rollers it must be guided by hand. The men supporting the cable should be spaced at between 4 to 6 m along the cable.

3.3 Laying by Motor Driven Rollers

Motorized rollers are used to pull the cable off the jacked up drum. It is advantageous to use rollers driven by electric motors installed in the cable trench at distances of 20 to 30 m. Where sharp bends occur it may be necessary to place such a roller at both the commencement and the end of the bend.

3.4 Pulling off by winches

Pulling off by winch is possible only if there are very few bends or other obstructions in the route.

After releasing the cable end from the drum a pulling stocking is placed over the end and tied in position. A rope is secured to the eye of the pulling stocking .

When laying unarmoured cables or steel-tape armoured cables with the aid of a winch, the rope can be secured to the cable via a pulling head which grips directly on to the conductors.

All cables, in particular single-core cables should not be straightened after laying, but left slightly meandering, to allow for longitudinal expansion and contraction during thermal cycling (changes in current loading).

Table 3
Permissible pulling force (guide values)

Means of pulling	Type of cable	Formula	Factor
With pulling head attached to conductors	All type of cable	$P = \sigma \cdot A$	$\sigma = 50 \text{ N/mm}^2$ (Cu-conductor) $\sigma = 30 \text{ N/mm}^2$ (Al- conductor)
With pulling stocking	Cable with metal sheath without pull resistant armouring.	$P = K \cdot d^2$	$K = 3 \text{ N/mm}^2$

When laying 3 single-core cable simultaneously with a common pulling stocking the same maximum pulling force applies, whereas the pulling force for 3 laid-up single-core cables is 3 times that of a single-core and for 3 non-laidup single-core cable is 2 time that of a single core.

- P Pull in N
- A Total cross sectional area in mm of all conductors (but not screen or concentric conductor)
- d Outside diameter of cable in mm
- σ Permissible tensile stress of conductor in N/ mm²
- K Empirically derived factor in N/ mm²

3.5 Plough-laying of Cables

In open terrain the cables may be plough-laid directly into the ground where circumstances permit, no obstructions, e.g. pipe runs which cross the route, and where protection of the cable with plastic plates or similar is not acceptable. This type of cable laying is particularly cost effective. Cables with PE sheath are particularly suitable for this form of laying .

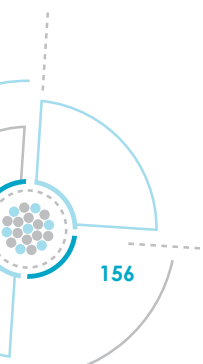

4- Laying of Single-Core Cables

For the laying of single-core cables under practical conditions, depending on local circumstances several methods have proved effective:

- Pulling-off and laying individual lengths in sequence,
- Simultaneously pulling-off three lengths from three cable drums.
- Laying of three pre-laid-up cables,
- Plough laying of three bunched cables.

If the three lengths are laid in sequence care must be taken that the cable already laid is not damaged by the cables following (e.g. by chaffing or abrasive action).

If on site sufficient space is available the simultaneous pulling off of three single-core cables from three individual drums has advantages. In a bunching bench the three cables are brought together for bunching in triangular formation for bunching and can then be laid as a single cable. The system is also proven where the three drums are carried on a suitably adapted flat back lorry.

5- Cable Tunnels and Ducts

The main advantage of using cable tunnels or ducts is the ease of access for replacement or extension of the installation without extensive workings.

Especially, where there is great cable massing, the cables installed in ducts can normally be subjected to higher loading than when laid in the ground. A disadvantage is the high cost of supply and installation of the ducts. For this reason installation in ducts is normally restricted to buildings and around outdoor switch gear plant.

In walk through ducts (cable tunnels) the cables are for practical reasons laid on cable trays above one another. Multi-core cables which are laid horizontally on the duct floor or on the trays do not require fixing.

The cables should be laid in the duct with a space between each approximately equal to the cable diameter. The load capacity of the cable may be determined. Since this is dependent on ambient air temperature a good natural ventilation should be provided in the duct (openings for ingoing and outgoing air).

Where necessary forced ventilation must be provided. With due consideration of the possibility of spreading of fire the cable ducts must be with barriers at least at the point of entry into operation rooms, switching stations, etc.

6- Side Wall Pressure

To preclude damage to the cable from the dynamic radial pressure, which develops when a cable is pulled around a bend under pulling tension, this pressure must be kept as low as possible.

Permissible maximum side wall pressure to the cable at bending point during installation is 1000 kg/m.

$$\text{NOTE: Side wall pressure to cable} = \frac{\text{pulling tension (kgf)}}{\text{bending radius (m)}} = \frac{T}{R}$$

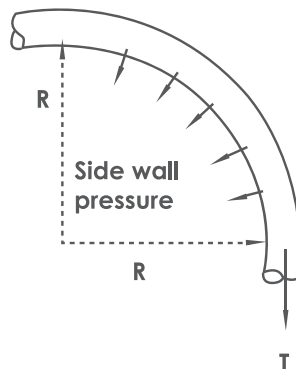

T: Pulling tension (kgf)
R: Bending radius (m)

Earthing of Single Core H.V. and E.H.V. Cables

Distribution voltage cables are normally installed with solidly bonded sheaths and, in order to minimize the sheath circulating currents on single-core cables produced by the magnetic flux linking the conductors and sheaths, they are nearly always laid in close touching trefoil formation. However, trefoil formation is poor for heat dissipation, as the three cables have a considerable heating effect upon one another. This is generally not a limitation for cable system at 33 kV but with larger conductor sizes and higher voltages alternative "specially bonded" systems are more economic.

Special bonding involves earthing the single-core cable sheaths at one point only and insulating all other points of the sheath from earth, so that the circulating sheath losses are eliminated and the phase cables can design be spaced apart to reduce their mutual heating effect without increasing sheath losses. If one termination only is grounded, the sheaths are subjected to a standing voltage of zero at the ground connection and maximum at the point furthest from this connection. This voltage is proportional to the conductor current and cable spacing. To protect the sheath insulation against transient voltages arising from lightning or switching transients it is therefore necessary to fit sheath voltage limiters (SVLs) at all joint and sealing end positions where the sheath is insulated from earth.

Three basic variations of specially bonded systems are commonly used: single end bonding, mid-point bonding and cross-bonding.

Specially Bonded Cable Systems

Single End Bonding System

In this system the sheaths at one termination are earthed and at the other termination are insulated from ground and fitted with SVLs. It is necessary to provide a separate earth continuity conductor for fault currents which would normally return via the cable sheaths. The standing voltage is proportional to the cable length and therefore the voltage limitation imposes a limitation on the length of the cable that may be bonded in this manner.

Diagram showing the principle of a power line earthing at one point

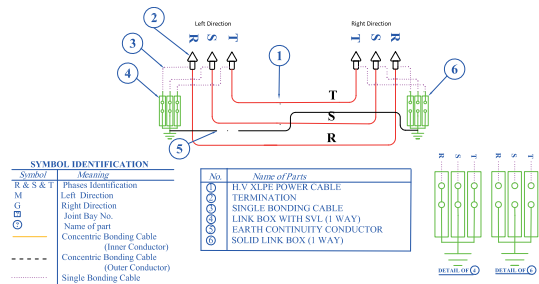

Mid-point Bonding System

Bonding of the mid-point is used where the route length is too long to employ a single end bonding system. In this system the cable is earthed at the mid-point (at joint) of the route and is insulated from ground and provided with SVLs at each termination or vice versa. It can be seen that this doubles the possible route length as the maximum allowable standing voltage can be tolerated at each sealing end or joint.

Earthing system mid-point

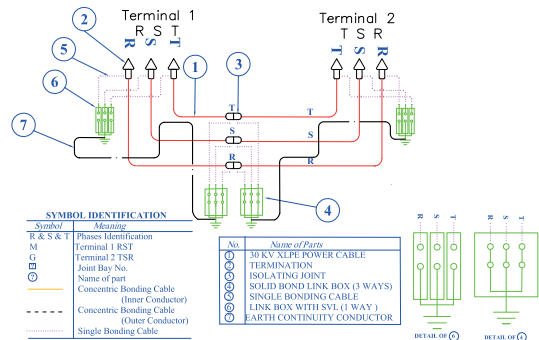

Cross-bonding System

In long routes, the route is split up into "major" sections, each comprised of three lengths and special joints are fitted. At each third joint position the sheaths are connected together and at all other positions they are connected so that all sheaths occupying the same position in the cable trench are connected in series. The sheaths at the intermediate positions are also connected to SVLs. The three sheaths connected in series are associated with conductors of different phases and when the cables are installed in trefoil formation their currents, and hence the sheath voltages, have equal magnitude but phase displacements of 120°. The overall effect is that the resultant voltage and current in the three sheaths are zero. When cables are laid in flat formation the voltages induced in the sheaths of the outer cable are greater than induced on the sheath of the middle cable and the phasor sum is not zero. The cables are therefore transposed at every joint position and the cross-connections are made with a phase rotation opposite to that of transposition so that the sheaths are effectively straight connected.

Cross - bonding system

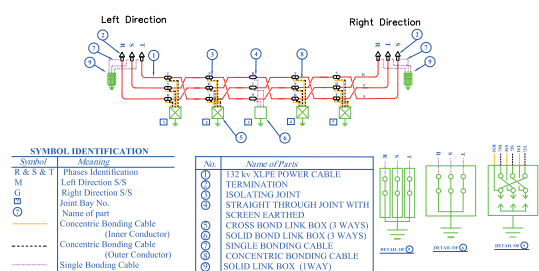

Type Test Approvals

Management System & Product Approval Certificates Awarded by Egytech Cables - Elsewedy Cables

System Certificate

SR	System	Certificate	Certification Body	Date of Award	Front Page Test Certificate
1	Quality Management System	ISO 9001-2000	BASEC	23/4/2007	ISO 9001-2000 Certificate
2	Environmental Management System	ISO 14001-2004	SGS	8/3/2006	ISO 14001-2004 Certificate
3	National Award for Excellence in Export		Industrial Modernization	2005	National Export Award 2005

Product Approval

SR	Product Description				Certification Body / Independent Lab	Date of Award	Standard / Specification	Front Page Test Certificate
	Type	Size mm ²	Volt	Construction				
1	Extra High Voltage	1x1000	230Kv	CU/XLPE/Lead Sheath/HDPE	KEMA - Netherland	7/3/2001	IEC 62067	Certificate
2	Extra High Voltage	1x800	220/130kv	CU/XLPE/Lead/HDPE	Egyptian Electrical Authority High Voltage Research Center	20/12/2003	IEC 62067	Certificate
1	High Voltage Cables	1x1600	38/66kv	CU-XLPE-Copper Wire-Copper Tape-HDPE	Egyptian Electrical Authority High Voltage Research Center	5/21/2005	IEC 60840	Certificate
2		1x500	132kv	CU/XLPE/Lead Sheath/HDPE	KEMA - Netherland	8/5/1999	IEC 60840	Certificate
3		1x400	38/66kv	CU/XLPE/Copper Sheath/HDPE	Egyptian Electrical Authority High Voltage Research Center	19/10/1998	IEC 60840	Certificate
4		1x400	38/66kv	CU/XLPE/Lead Sheath/HDPE	Egyptian Electrical Authority High Voltage Research Center	12/5/1998	IEC 60840	Certificate
5		1x400	38/66kv	CU-XLPE-Copper Wire-Copper Tape-HDPE	Egyptian Electrical Authority High Voltage Research Center	1/10/2005	IEC 60840	Certificate
6		1x1200	130/230kv	CU/XLPE/Lead/HDPE	Egyptian Electrical Authority High Voltage Research Center	4/29/2007	IEC 62067	Certificate
7		1x1200	130/230kv	CU/XLPE/LEAD/HDPE	Egyptian Electrical Authority High Voltage Research Center	11/8/2007	IEC 62067	Certificate
1	Medium Voltage Cables	1x800	6.35/11	CU/XLPE/CW/LEAD/LS0H	Egyptian Electrical Authority High Voltage Research Center	5/28/2006	IEC 60502-2	Certificate
2		1x400	18/30kv	AL/XLPE/PVC	Egyptian Electrical Authority High Voltage Research Center	12/31/1997	IEC 60502 & 60230	Certificate
3		1x400	12/20kv	AL/XLPE/PVC	Egyptian Electrical Authority High Voltage Research Center	3/23/1998	IEC 60502 & 60230	Certificate
4		1x300	19/33kv	AL/XLPE	KEMA - Netherland	7/7/2005	IEC 60502-2	Certificate
5		1x240	8.7/15kv	AL/XLPE	KEMA-Netherlands	2/13/2006	IEC 60502-2	Certificate
6		1x240	18/30kv	AL-XLPE-Copper Wire Screen PVC	Egyptian Electrical Authority High Voltage Research Center	6/25/2005	IEC 60502-2	Certificate
7		1x185	8.7/15kv	CU/XLPE/Lead Sheath/PVC	Egyptian Electrical Authority High Voltage Research Center	4/24/2001	IEC 60502-2	Certificate
8		1x185	6/10kv	AL/XLPE/Copper Sheath/PVC English	Egyptian Electrical Authority High Voltage Research Center	9/28/2003	IEC 60502-2	Certificate
9		1x185	6/10kv	AL/XLPE/Copper Sheath/PVC French	Egyptian Electrical Authority High Voltage Research Center	9/28/2003	IEC 60502-2	Certificate
10		1x120	18/30kv	AL/XLPE/Copper Sheath/PVC English	Egyptian Electrical Authority High Voltage Research Center	8/31/2003	IEC 60502-2	Certificate
11		1x120	18/30kv	AL/XLPE/Copper Sheath/PVC French	Egyptian Electrical Authority High Voltage Research Center	8/31/2003	IEC 60502-2	Certificate
12		1x120	18/30kv	AL/XLPE/Copper Sheath/PVC English	Egyptian Electrical Authority High Voltage Research Center	9/1/2003	IEC 60502-2	Certificate
13		1x120	18/30kv	AL/XLPE/Copper Sheath/PVC French	Egyptian Electrical Authority High Voltage Research Center	9/1/2003	IEC 60502-2	Certificate
14		3x240	19/33kv	CU/XLPE/STA/PVC	KEMA - Netherland	1/27/2005	IEC 60502-2	Certificate
15		3x240	18/30kv	AL/XLPE/STA/PVC	Egyptian Electrical Authority High Voltage Research Center	12/9/1997	IEC 60502-2	Certificate
16		3x240	12/20kv	AL/XLPE/STA/PVC	Egyptian Electrical Authority High Voltage Research Center	12/9/1997	IEC 60502-2	Certificate
17		3x240	6.35/11kv	CU/XLPE/STA/PVC Flame Retardant	KEMA - Netherland	8/8/2003	IEC 60332-3-24	Certificate
18		3x150	18/30kv	AL/XLPE/STA/PVC	Egyptian Electrical Authority High Voltage Research Center	12/31/1997	IEC 60502 & 60230	Certificate
19		3x150	6.35/11kv	CU/XLPE/STA/PVC	Egyptian Electrical Authority High Voltage Research Center	6/29/2004	BS-EN 50265, BS-EN 60811-3-1	Certificate
20		3x150	6.35/11kv	CU/XLPE/STA/PVC	Egyptian Electrical Authority High Voltage Research Center	6/8/2004	BS 6622	Certificate
21		3x300	8.7/15kv	AL/XLPE/STA/PVC	KEMA - Netherland	1/11/2007	IEC 60502-2	Certificate
22		1x500	18/30kv	CU/XLPE/PVC	KEMA - Netherland	3/12/2007	IEC60502	Certificate
23		1x500	18/30kv	CU/XLPE/PVC	KEMA - Netherland	4/13/2007	AEIC CS8(2006)	Certificate
24		1x500	19/33kv	AL/XLPE/HDPE	KEMA - Netherland	6/21/2007	IEC 60502-2	Certificate
25		3x240	18/30kv	CU/XLPE/STA/PVC	KEMA-Netherlands	7/23/2007	IEC60502-2	Certificate
26		3x240	18/30kv	CU/XLPE/STA/PVC	KEMA-Netherlands	7/26/2007	AEIC CS8(2006)	Certificate
27		1x400	19/33kv	CU/XLPE/STA/PVC	KEMA-Netherlands	9/13/2007	IEC60502-2	Certificate
28		1x500	19/33kv	AL/XLPE/HDPE	KEMA-Netherlands	3/27/2008	IEC60502-2	Certificate
29		3x240	6.35/11kv	CU/XLPE/STA/PVC	KEMA-Netherlands	20/5/2003	IEC60502-2	Certificate
30		1x300	8.7/15KV	CU/XLPE/PVC	KEMA-Netherlands	13/5/2008	IEC60502-2	Certificate
31		1x500	19/33KV	CU/XLPE/MDPE	KEMA-Netherlands	13/5/2008	BS7870-4.10	Certificate
32		3x185	8.7/15KV	CU/XLPE/PVC	KEMA-Netherlands	13/5/2008	IEC60502-2	Certificate
33		3x150	3.6/6KV	CU/XLPE/PVC	KEMA-Netherlands	13/5/2008	IEC60502-2	Certificate
34		1x300	8.7/15KV	CU/XLPE/PVC	KEMA-Netherlands	13/5/2008	AEIC CS8-06(2006)	Certificate
35		3x185	8.7/15KV	CU/XLPE/PVC	KEMA-Netherlands	13/5/2008	AEIC CS8-06(2006)	Certificate
36		3x150	3.6/6KV	CU/XLPE/PVC	KEMA-Netherlands	13/5/2008	AEIC CS8-06 (2006)	Certificate

Type Test Approvals

Management System & Product Approval Certificates Awarded by Egytech Cables - Elsewedy Cables

Product Approval

	Product Description				Certification Body/Independent Lab	Date of Award	Standard / Specification	Front Page Test Certificate
	Type	Size mm ²	Volt	Construction				
1		1x630	0.6/1kv	AL/PVC/PVC	Egyptian Electrical Authority High Voltage Research Center	1/26/2005	IEC 60502-1	Certificate
2		1x70	0.6/1kv	AL/PVC	Egyptian Electrical Authority High Voltage Research Center	11/8/1997	IEC 60502 & 60228	Certificate
3		1x70	0.6/1kv	AL/XLPE +2.5% Carbon Black	Egyptian Electrical Authority High Voltage Research Center	8/13/2003	IEC 60502 & 60228	Certificate
4		1x16	0.6/1kv	AL/PVC	Egyptian Electrical Authority High Voltage Research Center	6/23/1998	IEC 60502 & 60228	Certificate
5		1x3 1x6 1x10 1x16	0.6/1kv 0.6/1kv 0.6/1kv 0.6/1kv	CU/PVC	Cairo Universty, Faculty of Engineering Energy Research Center	3/4/1998	IEC 60227	Certificate
6		3X240+120	0.6/1kv	CU/PVC/DSTA/PVC English	Egyptian Electrical Authority High Voltage Research Center	17/12/1997	IEC 60502 & 60228	Certificate
7		3X240+120	0.6/1kv	CU/PVC/DSTA/PVC Arabic	Egyptian Electrical Authority High Voltage Research Center	17/12/1997	IEC 60502 & 60228	Certificate
8		3X240+120	0.6/1kv	AL/PVC/STA/PVC English	Egyptian Electrical Authority High Voltage Research Center	15/11/1997	IEC 60502 & 60228	Certificate
9		3X240+120	0.6/1kv	AL/PVC/STA/PVC Arabic	Egyptian Electrical Authority High Voltage Research Center	15/11/1997	IEC 60502 & 60228	Certificate
10		3x185+95	0.6/1kv	AL/PVC/DSTA/PVC English	Egyptian Electrical Authority High Voltage Research Center	17/12/1997	IEC 60502 & 60228	Certificate
11		3x185+95	0.6/1kv	AL/PVC/DSTA/PVC Arabic	Egyptian Electrical Authority High Voltage Research Center	17/12/1997	IEC 60502 & 60228	Certificate
12		3X120+70	0.6/1kv	CU/PVC/DSTA/PVC	Egyptian Electrical Authority High Voltage Research Center	17/12/1997	IEC 60502 & 60228	Certificate
13		3X70+35	0.6/1kv	CU/XLPE/SWA/LSOH	Warrington Fire Research Consultancy - Testing London	4/3/1997	IEC 60332	Certificate
14		3X70+35	0.6/1kv	AL/PVC/DSTA/PVC English	Egyptian Electrical Authority High Voltage Research Center	17/12/1997	IEC 60502 & 60228	Certificate
15		3X70+35	0.6/1kv	AL/PVC/DSTA/PVC Arabic	Egyptian Electrical Authority High Voltage Research Center	17/12/1997	IEC 60502 & 60228	Certificate
16		3X35	0.6/1kv	CU/XLPE/SWA/LSHF	KEMA-Netherlands	9/13/2006	BS EN50267-2-1&BS EN 50267-2-2&BS EN 61034-1&BS61034-2&BS EN 50266-2-4	Certificate
17		4X240	0.6/1kv	CU/XLPE/SWA/PVC Flame Retardant	KEMA-Netherlands	8/8/2003	IEC 60332-3-24	Certificate
18		4X240	0.6/1kv	CU/XLPE/SWA/PVC	KEMA-Netherlands	20/5/2003	IEC 60502-1	Certificate
19		4x16 4x25 4x95 4x150	0.6/1kv 0.6/1kv 0.6/1kv 0.6/1kv	CU/XLPE/SWA/PVC Flame&Heat Test	Egyptian Electrical Authority High Voltage Research Center	29/6/2004	BS-EN 50285 BS-EN 60811-3-1	Certificate
20		4x16 4x25 4x95 4x150	0.6/1kv 0.6/1kv 0.6/1kv 0.6/1kv	CU/XLPE/SWA/PVC	Egyptian Electrical Authority High Voltage Research Center	8/6/2004	BS 5467	Certificate
21		1x35 1x150	450/750V 450/750V	CU/PVC Flame&Heat Test	Egyptian Electrical Authority High Voltage Research Center	29/6/2004	BS-EN 50285 BS-EN 60811-3-1	Certificate
22		1x35 1x150	450/750V 450/750V	CU/PVC	Egyptian Electrical Authority High Voltage Research Center	6/8/2004	IEC 60227-2 & 60227-3	Certificate
23		1X1.5	450/750V	CU/PVC	Self Declaration	4/1/2006	HD 21.3 S3	Certificate
24		1X2.5	450/750V	CU/PVC	Self Declaration	4/1/2006	HD 21.3 S3	Certificate
25		1X6	450/750V	CU/PVC	Self Declaration	4/1/2006	HD 21.3 S3	Certificate
26		4X2.5	0.6/1kv	CU/XLPE/SWA/PVC	Self Declaration	4/1/2006	IEC 60502-1 IEC 60332-3 Cat.	Certificate
27		1X1	300/500V	CU/PVC	Self Declaration	30/4/2006	HD 21.3 S3	Certificate
28		1X25	450/750V	CU/PVC	Self Declaration	30/4/2006	HD 21.3 S3	Certificate
29		1X50	450/750V	CU/PVC	Self Declaration	30/4/2006	HD 21.3 S3	Certificate
30		1X95	450/750V	CU/PVC	Self Declaration	30/4/2006	HD 21.3 S3	Certificate
31		1X185	450/750V	CU/PVC	Self Declaration	30/4/2006	HD 21.3 S3	Certificate
32		1X300	450/750V	CU/PVC	Self Declaration	30/4/2006	HD 21.3 S3	Certificate
33		4x300	0.6/1kv	AL/XLPE/PVC	KEMA - Netherland	1/11/2007	IEC 60502-1	Certificate
34		1x630	0.6/1kv	CU/XLPE/PVC	KEMA - Netherland	1/10/2007	IEC 60502-1	Certificate
35		4x300	0.6/1kv	CU/XLPE/SWA/LSHF	KEMA - Netherland	1/18/2007	BS 6724	Certificate
36		25sqmm to 400sqmm	0.6/1kv	CU/XLPE/SWA/PVC	BASEC	3/12/2008	BS 5467	Certificate
37		25sqmm to 400sqmm	0.6/1kv	CU/XLPE/SWA/LSOH	BASEC	3/17/2008	BS 6724	Certificate
38		1X50	450/750V	CU/PVC G/Y	VDE	3/7/2008	HD 21.3 S3	Certificate

Low Voltage Cables

Type Test Approvals

Management System & Product Approval Certificates Awarded by Egytech Cables - Elsewedy Cables

	Product Description				Certification Body/Independent Lab	Date of Award	Standard / Specification	Front Page Test Certificate		
	Type	Size mm ²	Volt	Construction						
Product Approval	Low Voltage Cables	39	1x10	450/750V	CU/PVC	Self Declaration	8/30/2006	BS 6004	Certificate	
		40	1x10	450/750V	CU/PVC (Gray)	Self Declaration	8/30/2006	BS 6004	Certificate	
		41	1x10	450/750V	CU/PVC (Blue)	Self Declaration	8/30/2006	BS 6004	Certificate	
		42	1x10	450/750V	CU/PVC (Brown)	Self Declaration	8/30/2006	BS 6004	Certificate	
		43	1x10	450/750V	CU/PVC (Black)	Self Declaration	8/30/2006	BS 6004	Certificate	
		44	1x16	450/750V	CU/PVC (G/Y)	Self Declaration	8/30/2006	BS 6004	Certificate	
		45	1x16	450/750V	CU/PVC (Gray)	Self Declaration	8/30/2006	BS 6004	Certificate	
		46	1x16	450/750V	CU/PVC (Blue)	Self Declaration	8/30/2006	BS 6004	Certificate	
		47	1x16	450/750V	CU/PVC (Brown)	Self Declaration	8/30/2006	BS 6004	Certificate	
		48	1x16	450/750V	CU/PVC (Black)	Self Declaration	8/30/2006	BS 6004	Certificate	
		49	4x35	0.6/1kv	CU/XLPE/SWA/PVC	Self Declaration	8/17/2006	BS 5467	Certificate	
		50	4x150	0.6/1kv	CU/XLPE/SWA/PVC	Self Declaration	9/3/2006	BS 5467	Certificate	
		51	2x16	0.6/1kv	CU/XLPE/SWA/PVC	Self Declaration	12/19/2006	BS 5467	Certificate	
		52	3x16	0.6/1kv	CU/XLPE/SWA/PVC	Self Declaration	12/19/2006	BS 5467	Certificate	
		53	4x240	0.6/1kv	CU/XLPE/SWA/PVC	Self Declaration	1/14/2007	BS 5467	Certificate	
		54	1x1	450/750V	CU/PVC Brown	Egyptian Electrical Authority High Voltage Research Center	2/25/2007	BS 6004-2000 BS EN 50396-2005	Certificate	
			1 X 1	450/750	CU/PVC Yellow					
			1x2	450/750	CU/PVC Blue					
			1x16	450/750	CU/PVC Black					
			1x25	450/750V	CU/PVC Yellow/Red					
			1x50	450/750V	CU/PVC Red					
			1x95	450/750V	CU/PVC Red					
			1x185	450/750V	CU/PVC Red					
			1x300	450/750V	CU/PVC Yellow					
			55	1x630	450/750v		CU/LSOH			BASEC
		56	4x400	0.6/1kv	CU/XLPE/SWA/PVC	BASEC	8/29/2007	BS5467	Certificate	
		57	25sqmm to 630sqmm	450/750v	CU/PVC	BASEC	8/29/2007	BS6004	Certificate	
		58	2x4	0.6/1kv	CU/XLPE/SWA/PVC	Self Declaration	8/5/2007	BS5467	Certificate	
		59	2x6	0.6/1kv	CU/XLPE/SWA/PVC	Self Declaration	8/5/2007	BS5467	Certificate	
		60	2X25	0.6/1kv	CU/XLPE/SWA/PVC	Self Declaration	4/20/2008	BS5467	Certificate	
		61	NY Y	0.6/1kv	CU/PVC/PVC	VDE	9/27/2007	HD603 S1:1994/A2:2003	Certificate	
		1	Over Head Transmission Line	1x400		AAAC	Egyptian Electrical Authority High Voltage Research Center	27/10/1997	IEC 60208	Certificate
				380-50		ACSR			IEC 60209	
1x70				AAAC	IEC 60208					
1x150				AAAC	IEC 60208					
4X35	600V			AL/XLPE+2.5%CB	Alex. University, Faculty of Engineering Electrical Engineering Dept.	30/11/1998			IEC 60502 & 60540 & 60228	
4	1x54.6+3x70+2x16	0.6/1kv	Aerial Bundle Cables	Egyptian Electrical Authority High Voltage Research Center	25/10/2004	NFC 33-209 IEC 60811	Certificate			
5	1X35	0.6/1kv	AL/PVC+2.5%CB	Egyptian Electrical Authority High Voltage Research Center	23/3/1998	IEC 60502 & 60228	Certificate			
1	OPGW Cable	79/33	IL	OPGW 79/33 14KA/1sec 48 fibers	KINECTRICS INTERNATIONAL	3/21/2006	IEEE1138	Certificate		
SASO Product Appro	1	High Voltage Cables			Intertek ETL SEMKO	7/11/2006	IEC 60228 & 60889 & 60104 & 61232 & 61089 & 60227-1 & 60227-3 & 60227-2 & 60227-6 & 60227-5 & 60227-7 & 60227-4 & 60502-2 & 60502-1	Certificate		
		Medium Voltage Cables								
		Low Voltage Cables								
2	H.V	1X1000 1X1200	110KV	CU/XLPE/CUW/LAT/HDPE CU/XLPE/CUW/LAT/HDPE	Intertek ETL SEMKO	21/5/2008	IEC 60840	Certificate		

Type Test Approvals

Management System & Product Approval Certificates Awarded by Egytech Cables - Elsewedy Cables

	Product Approval	Product Description			Certification Body/Independent Lab	Date of Award	Standard / Specification	Front Page Test Certificate
		Type	Size mm ²	Construction				
EOS	Product Approval	1- EOS Certificate (A) EOS Certificate (E) 2- Contract between EOS & EGYTECH Cables 3- Test Report for:			Ministry of Trade & Industry EOS	1/7/2007	ES 182/2005 IEC 60227 BS 6004 HD 21.3	Certificate Ar.
		1	1mm2 50mm2 185mm2	25mm2 95mm2 300mm2				Certificate En.
PAI Approval	Product Approval	CU/XLPE/SWA/PVC L.V			Intertek International Limited	16/12/2007	BS5467-97- IEC60502-1	Certificate
		CU/XLPE/STA/PVC L.V						
		CU/XLPE/PVC L.V						
		CU/PVC Wires						
		CU/PVC/PVC						
BASEC	Product Approval	Indoors Wires, Control and Low Voltage Cables Up to 1 Kv Medium Voltage cables Up to 36 Kv High Voltage Cable Up to 150 Kv Extra High Voltage Cables Up to 220 Kv Overhead Transmission Lines Up to 500 Kv Execution of Turn Key Projects for 220 Kv Cables Optical Ground Wires Including Installation			BASEC	5/9/2007	BA 2250:1996	BASEC SCHEME
PVC Samples	Product Approval	PVC Sheath Sample			KEMA	16/5/2008	IEC 60502-2 (2005)	Certificate

* CD available containing all certificates

Cables Clarification Sheet

Rated Voltage

- 450/750 V
 0.6/1 kV
 1.8/3 kV (1.9/3.3 kv)
 3.6/6 kV (3.8/6.6 kv)
 26/45 kV
 6/10 kV (6.35/11 kv)
 8.7/15 kV
 12/20 kV (12.7/22 kv)
 18/30 kV (19/33 kv)
 64/110 kV
 38/66 kV
 76/132 kV
 127/220 kV
 87/150 kV
 500 kV

Conductor C.S.A = mm²

- Copper
 Solid
 Stranded
 Flexible
 Milliken
 Aluminium
 Solid
 Stranded

Insulation

- PVC
 PVC - F.R
 XLPE
 LSHF

Copper Screen

Short Circuit Current = kA

- Copper Wire
 Copper Tape
 Copper (Tape + Wire)

Metallic Sheath

- Lead
 Lead Alloy
 Aluminum

Armour

- Steel
 Tape
 Galvanized Tape
 Galvanized Wire
 Aluminium
 Tape
 Wire

Sheathing (Overall Jacket)

- PVC
 PVC - F.R
 HDPE
 LSHF
 LLDPE
 MDPE
 Other

System's Certificates

BASEC
BRITISH APPROVALS SERVICE FOR CABLES

CERTIFICATE OF CONFORMITY

BASEC hereby certifies that:

EL SEWEDY CABLES - EGYPT
Incorporating:

Egyptech Cables (El Sewedy), Plot 27, 1st District, New Cairo, Egypt
 Egyptech Cables A3 (El Sewedy), 10th of Ramadan City, Industrial Zone A3, Cairo, Egypt
 Egyptech Cables A1 - El Sewedy, 10th of Ramadan City, Industrial Zone A1, Cairo, Egypt

Has implemented and maintains a Management System that fulfils the requirements of the following standard

BS EN ISO 9001: 2015
Permitted exceptions: none or stated ...

In respect of the site (s) and scope (s) specified in the below schedule (s)

Schedule no(s):

CS1-185/002.1
 CS1-185/002.2
 CS1-185/002.3

Certificate No: CS1-185/002.0 Issue: 08 Issue Date: 19th October 2017
 Date of initial certification: 8th February 2007 Expiry Date: 4th November 2020
 Last certification cycle expiry date: 4th November 2017

Lack of fulfilment of conditions as set out in the certification agreement may render this Certificate invalid. This certificate is issued subject to and in accordance with BASEC Regulations and continued compliance.

Signed for and on behalf of the British Approvals Service for Cables

[Signature] Date: 5/11/2017

BASEC **UKAS**

ISO 9001 UKAS MANAGEMENT SYSTEMS

Certificate E0392381

The management system of

El Sewedy Cables Group
Zone A1, A3, 10th of Ramadan City, Cairo, Egypt

has been assessed and certified as meeting the requirements of

ISO 14001:2004

For the following activities

Design, Manufacture and supply of:

- Building wires, indoor wires, control and low voltage cables up to 1 kV.
- Medium voltage cables up to 38 kV.
- High voltage cables up to 130 kV.
- Extra high voltage cables up to 400 kV.
- Overhead transmission lines up to 500 kV and execution of turn key projects for 220 kV.
- Optical ground wires including installation local and export purchasing.

This certificate is valid from 22 December 2015 until 15 September 2018 and remains valid subject to satisfactory surveillance audits. Recertification audit due before 15 August 2016 Issue 4. Certified since 18 December 2003

This is a multi-site certification. Additional site details are listed on the subsequent page.

Authorised by

[Signature]

SGS United Kingdom Ltd. Systems & Services Certification
 Resources Business Park, Epsom Road, Chertsey, Surrey, UK
 T +44 (0)1753 350000 F +44 (0)1753 350000 www.sgs.com

SGS (UK) Ltd 0718 101

Page 1 of 2

SGS **UKAS**

ISO 14001 UKAS MANAGEMENT SYSTEMS

Accreditation Certificate No. (211021A)

EGAC **ILAC-MRA**

Arab Republic of Egypt
Egyptian Accreditation Council (EGAC)

Certifies that

El Sewedy Cables Egypt Laboratory
El Sewedy Cables Company
 Industrial Zone A3 - 10th of Ramadan City
 Shargia - Egypt

Has been accredited by EGAC in compliance with the requirements of

ISO/IEC 17025:2005
 In some Electrical and Non Electrical Tests for Power Cables
 with Rated Voltage Up To 230 kV

The scope of accreditation is described in the attached schedule No. (211021B),
 Scope Issue No.(2)

Issue No. (2): October 24, 2016 Valid to: August 13, 2020

Subject to continued compliance to the above standard
 and the requirements of EGAC

EGAC is an ILAC MRA signatory in the field of Calibration and Testing Labs accreditation

Eng. Hany El Desouki
 EGAC Executive Director

Eng. Tarek Kabil
 Chairman of EGAC
 Minister of Trade and Industry

Certificate E0153448

The management system of

El Sewedy Cables Group El Sewedy Cables (Egypt) Egyptech Cables A1 (El Sewedy) Egyptech Cables A3 (El Sewedy)
Zone A1, A3, 10th of Ramadan City, Cairo, Egypt

has been assessed and certified as meeting the requirements of

BS OHSAS 18001:2007

For the following activities

The scope of registration appears on page 2 of this certificate.

This certificate is valid from 8 May 2015 until 8 May 2018 and remains valid subject to satisfactory surveillance audits. Re certification audit due before 8 February 2016 Issue 1. Certified since 8 May 2015

This is a multi-site certification. Additional site details are listed on subsequent pages.

Authorised by

[Signature]

SGS United Kingdom Ltd. Systems & Services Certification
 Resources Business Park, Epsom Road, Chertsey, Surrey, UK
 T +44 (0)1753 350000 F +44 (0)1753 350000 www.sgs.com

SGS (UK) Ltd 0718 101

Page 1 of 2

SGS **UKAS**

ISO 14001 UKAS MANAGEMENT SYSTEMS

Product's Certificates



Our Partners



Elsewedy Electric Contacts

HEAD OFFICE

Plot No. 27, 1st District, 5th Settlement,
P.O.Box 311, New Cairo 11853, Egypt
Tel.: (+202) 275 99 700 - 709
Fax: (+202) 275 99 731
Email: info@elsewedy.com
Address in Head Office

CABLES & ACCESSORIES

Egytech Cables & Elsewedy Cables Egypt
Tel.: (+202) 275 99 732 / 4
Fax: (+202) 275 99 735
Email: info-egytech@elsewedy.com
Email: info-scegypt@elsewedy.com

United Industries

Tel.: (+202) 275 99 740 / 1 / 2
Fax: (+202) 275 99 743 / 15 / 69
Email: info-uic@elsewedy.com

Egyplast

Area #A6; Plot 36,37. 3rd industrial zone,
Elrobeky Region, 10th of Ramadan City,
El Sharkia, Egypt
Tel.: (+2015) 411 631
Fax: (+2015) 411 629
Email: egyplast@elsewedy-plastic.com

UEIC Elsewedy

P.O. Box 27350 Riyadh 11417
Tel.: (+966) 18124604 - Fax: (+966)
18129251
Email: info-ueic@elsewedy.com
United Wires
10th of Ramadan City, Zone A3, El Sharkia,
Egypt
Tel.: (+2015) 411944
Fax: (+2015) 411941
Email: info-uwc@elsewedy.com

United Metal

Fax: (+202) 275 99 744 / 45
Email: info-umc@elsewedy.com

Elsewedy Sedco

Tel.: (+2015) 411141
Tel.(Office): (+202) 275 99 750 / 1
Email: info-sedco@elsewedy.com

Elastimold - Egypt

Tel.: (+2015) 411141
Tel.(Office): (+202) 275 99 750 / 1
Email: info-elastimold@elsewedy.com

Giad Elsewedy

Giad Industries City, Khartoum, Sudan
P.O. Box 11714
Tel.: (+249) 163 202771
Fax: (+249) 183 70106
Email: info-giadcables@elsewedy.com

Elsewedy Cables KSA

Nassar Center, King Fahd Road Al Azizah,
P.O.BOX 16582, Jeddah - 21474,
Saudi Arabia
Tel.: (+966) 266 87 488 - (+966) 266 87 499
Fax: (+966) 266 87 480
Email: info-ksa@elsewedy.com

Elsewedy Cables Algeria

153 rue Ali Khodja, El Biar, Alger, Algeria
Tel.: (+213) 21924005/07
Fax: (+213) 21 923994
Email: info-algeria@elsewedy.com

Elsewedy Cables Ethiopia

PO BOX 3238 Code 1250, Edna Mall
Building,
5th Floor Addis Ababa, Ethiopia
Tel.: (+251) 116 61 6161
Fax: (+251) 116 61 6164
Email: info-ethiopia@elsewedy.com

Doha Cables

3rd floor, KIA Motors Showroom bldg.,
Al Rayyan road ,Al Sadd, P.O. Box 2248,
Doha, Qatar
Tel.: (+974) 4033 95 02 / 503
Fax: (+974) 4455 30 49
Email: info@dohacables.com

ELECTRICAL PRODUCTS

Elsewedy Sedco for petroleum services

Tel.: (+202) 275 99 750 / 1
Fax: (+202) 275 99 752
Email: info-sedcopetroleum@elsewedy.com

Egyptian Company for Manufacturing

Electrical Insulators ECMEI
Industrial Zone A3, 10th of Ramadan City,
Egypt
Tel.: (+2015) 412 560
Fax: (+2015) 411 255
Email: ecmei@elsewedy.com
Email: info@ecmei.com

Elsewedy Electric Ghana

9, Light Industrial Area No. A/36/2B Tema -
Ghana. P.O. Box PMB 187 TEMA - Ghana
Tel.: (+233) 111 01 - 111 02
Fax: (+233) 11103
Email: info-ghana@elsewedy.com

ENERGY MEASUREMENT & MANAGEMENT

ISKRAEMECO

Iskraemeco Savska loka 4 SI-4000 Kranj,
Slovenia
Fax: (+386) 420 64 443
Email: info-iskraemeco@elsewedy.com

ISKRAEMECO - Egypt

Fax: (+202) 275 99 747 / 8
Email: info@iskraemeco.com.eg

TRANSFORMERS

Elsewedy Transformers

Tel.: (+202) 275 99 727
E-mail: info-transformers@elsewedy.com

Elsewedy Electric Zambia

Chilanga road off Kabwe road, Plot
F/416A/D2 - P.O. Box
70058 Ndola, Zambia.
Tel.: +260 (212) 650120/1
Email: info-zambia@elsewedy.com

Elsewedy Electric Nigeria

Toga-Zanumu Industrial Area, Limca Bus
Stop,
Badagry Expressway, Lagos - Nigeria
Mob.: (+234) 809 900 0070
Email: nigeria@elsewedy.com

SUDATRAF Sudanese Egypt Electrical Industries

Piece # 55/8 Square 7 Ind. Zone -
Khartoum Bahary - Sudan
Tel.: (+249) 185 31 34 18
Fax: (+249) 185 31 33 94
Email: info-sudatraf@elsewedy.com

COMMUNICATIONS

United Industries

Fax: (+202) 275 99 743 / 69 / 15
Email: info-uic@elsewedy.com

3W Networks - UAE

Jebel Ali Free Zone - Dubai
Tel.: (+971) 488 33 616
Fax: (+971) 488 34 878
Email: info-uae-3wnetworks@elsewedy.com

PROJECTS & DEVELOPMENTS

Elsewedy Electric Transmission & Distribution

Fax: (+2015) 411 629
Email: info-EETD@elsewedy.com

Elsewedy Power

Fax: (+2015) 411 629
Email: info-power@elsewedy.com

Power System Projects (PSP)

Plot 246 -2nd sector of City Center
5th Settlement, New Cairo, Egypt
Tel.: (+202) 251 726 37 / 50 / 51
Fax: (+202) 251 726 36
Email: info-psp@elsewedy.com

Elsewedy Cables-Qatar

3rd floor, KIA Motors Showroom bldg.,
Al Rayyan road, Al Sadd, P.O. Box 22487,
Doha, Qatar
Tel.: (+974) 40339500 / 501
Fax: (+974) 44653892
Email: infoqatar@elsewedy.com

WIND ENERGY GENERATION

SET (SIAG Elsewedy Towers)
Ain sokhna, South of the Economic zone,
North West Gulf of Suez, Egypt
P.O. Box 117-ET-43111 Suez
Tel.: (+2062) 920 4250
Fax: (+2062) 920 4255
Email: info-set@elsewedy.com

SOLAR ENERGY SOLUTIONS

Elsewedy Power

Email: info-power@elsewedy.com

INTERNATIONAL OPERATION

Elsewedy Cables - Kuwait

Kuwait City, Al Hamad Tower A, Block 14,
Phase (1B), 4th Floor, P.O.Box 4588
Tel.: (+965) 999788878
Fax: (+965) 22974404
Email: info-kuwait@elsewedy.com

Elsewedy Cables - UAE

Arengo Tower-Sheikh Zayed road
12th Floor, Office No. 1207
P.O.Box 90395, Dubai, UAE
Tel.: (+971) 44542500
Fax: (+971) 44 542501
Email: info-uae@elsewedy.com

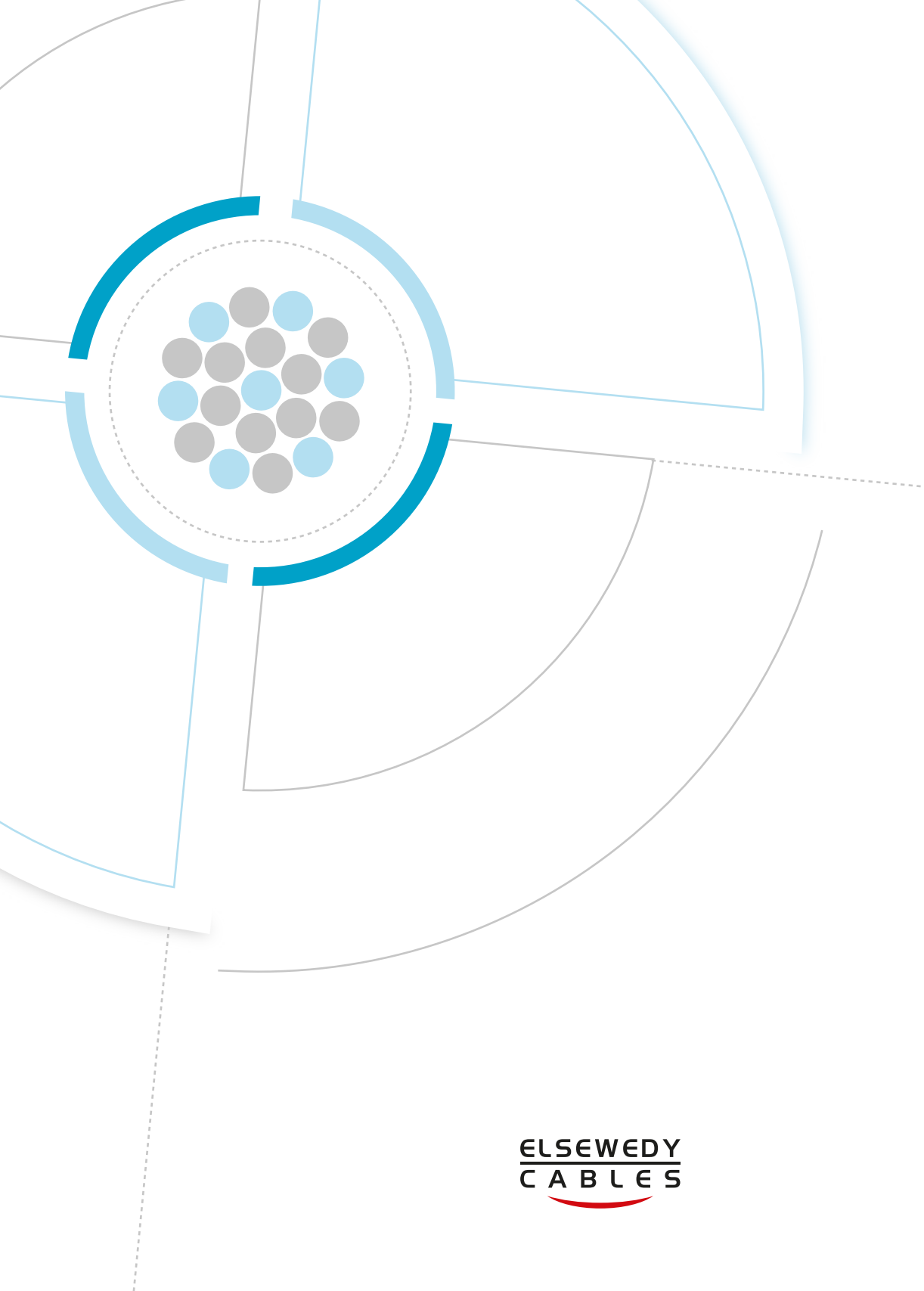

ELSEWEDY
CABLES

POWER CABLES CATALOGUE
PROVIDING SAFE ENERGY

Plot 27, 1st district, road 90, 5th Settlement
New Cairo, Cairo - Egypt.
Tel.: +202 275 99 700 / 1
Fax: +202 275 99 731
E-mail: info@elsewedy.com

www.elsewedy.com

 **19159**