

TECHNICAL DETAILS

FULL-COLOR WIDE SERIES

BS-TYPE , A-TYPE

FULL-COLOR WIDE SERIES Refina

BS-TYPE , A-TYPE

FULL COLOR
WIDE
SERIES

FULL COLOR
WIDE
SERIES
Refina

Switches 16AX

BS-TYPE 1Way Switch

A-TYPE 1Way Switch



WEBP515117



WEBP525217



WEBP535317



WEGP515117

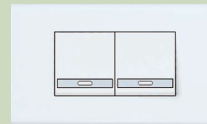

WEGP525217

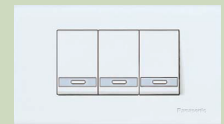

WEGP535317

Technical Specifications

- ▶ Standards
Comply with IEC60669-1
- ▶ Rating
16AX 250V~
- ▶ Ambient Temperature
-10°C – +40°C
- ▶ Representative Performance
 - Electric strength : 2,000V 1 min
 - Operation test : 40,000 Operations
 - Temperature rise : Test current 20A (2.5 mm²)
Not more than 45K (Terminals)
- ▶ Terminal
Pillar Terminal II
- ▶ Applicable Wire
1.5 mm² - 4 mm²
15 AWG - 12 AWG
- ▶ Terminal Capacity
1.5 mm² × 3
2.5 mm² × 2
4 mm² × 1

Features

Improved contact reliability through our design using proprietary technology.

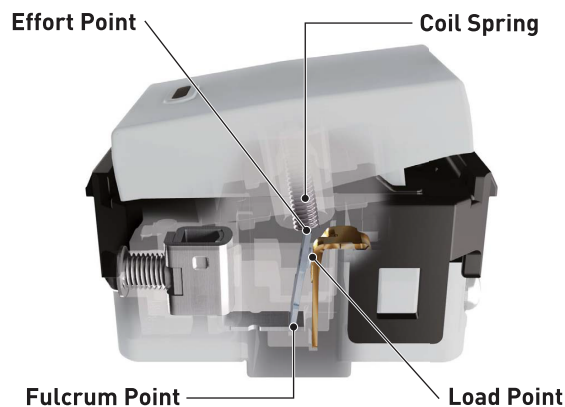

Coil Spring Reversal Method

Panasonic's proprietary coil spring reversal method, causes the pressure applied on the connector to be stable, so that it does not become very hot. By keeping the bound small, the production of arc energy is minimised.

- Because the damage is small, the contacts do not fuse easily, making them long lasting.
- Our products have cleared the On/Off testing for 40,000 operations required by IEC.

Urea Resin

The use of urea resin which is safer and more secure has led to improved fire resistance. It also has excellent tracking resistance which prevents electric shocks.

- Even when the product is wrongly used, the casing does not fuse. As such, it is fire proof and shock proof.
- It is resistant to fire caused by tracking on the surface of the socket, and the material itself does not melt easily.
- Since the material is highly insulated so that electricity does not pass through it, it is shock proof.

Pillar Terminal

- Built-in pillar terminal accommodates any wire configuration.
- 1 mm² - 4 mm²

Features

Urea Resin

Characteristics of Urea Resin

- Excellent arc resistance, arc tracking resistance, flame retardance, heat resistance, color fastness.
- Has good electrical performance and mechanical strength with excellent abrasion resistance.
- Difficult to scratch, and there is virtually no adherence of dust due to static electricity.
- Organic solvents and oily substances cannot permeate.

Enclosure Material Characteristics (reference)

| | Urea | PBT | Polycarbonate |
|----------------------|-----------|------|---------------|
| Tracking Performance | Excellent | Good | Poor |
| Heat Deformation | Good | Good | Fair |
| Self-Extinguishment | Good | Good | Good |

Coil Spring Reversal Method

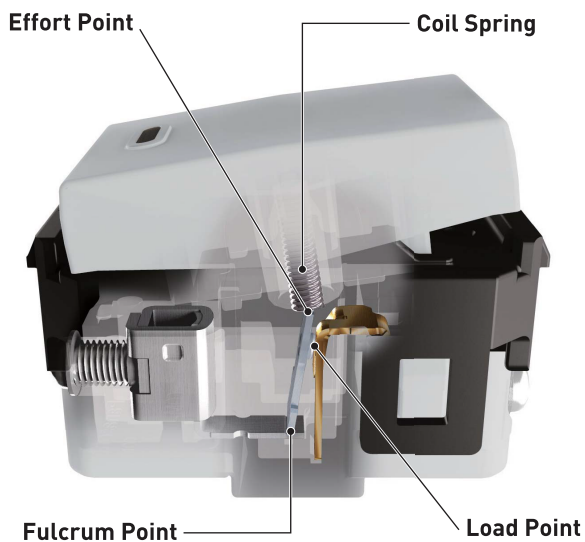

Bounce Performance Comparison

The Full-Color Series has a coil spring system to reduce arc energy generation, making it ideal for compact fluorescent lighting (CFL), inverter illumination and LED lighting.

Coil Spring System

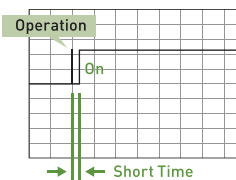

Contact deposition almost never occurs, so contact damage is minimal.

Seesaw Type of Switching System

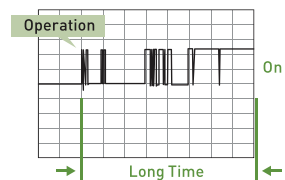

Contact deposition occurs easily and causes faster wear.

Terminal

Socket



Switch



Flexible wire (class 5) also applicable

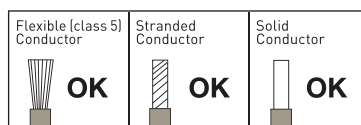

Rigid (Solid or Stranded) & Flexible (only class 5) Copper Conductor Type

TECHNICAL DETAILS

Dimensions

BS-TYPE 1Way Switch

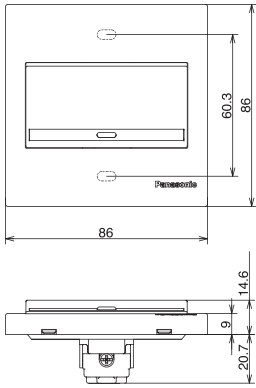

WEBP515117

*BS-TYPE : with screws for insert.

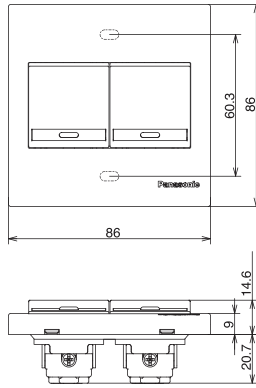

WEBP525217

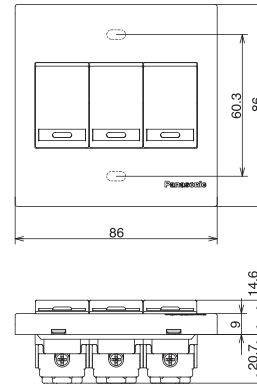

WEBP535317

A-TYPE 1Way Switch

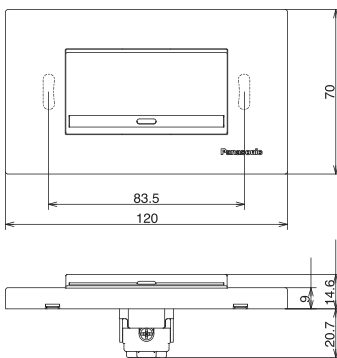

WEGP515117

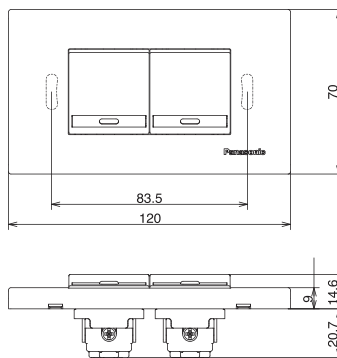

WEGP525217

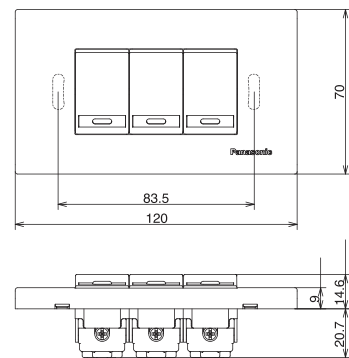

WEGP535317

Applicable Box

BS-TYPE



► Dimensions

Plate : 86 x 86 mm
 Box : 72 x 72 mm
 Fixing Center : 60.3 mm



► Dimensions

Plate : 86 x 146 mm
 Box : 72 x 132 mm
 Fixing Center : 120.6 mm

A-TYPE



► Dimensions

Plate : 70 x 120 mm
 Box : 51 x 102 mm
 Fixing Center : 83.5 mm

FULL-COLOR WIDE SERIES

BS-TYPE , A-TYPE

FULL-COLOR WIDE SERIES Refina

BS-TYPE , A-TYPE

FULL COLOR
WIDE
SERIES

FULL-COLOR
WIDE
SERIES
Refina

Switches 20A

BS-TYPE DP Switch with Indicator

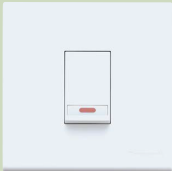

WEG55337

WEB7811W

WEBP5410600F

A-TYPE DP Switch with Indicator



WEG55337

WEG6801WK-P

WEGP5414600F

Technical Specifications

- ▶ Standards
 - Comply with IEC60669-1
- ▶ Rating
 - 20A 250V~
- ▶ Ambient Temperature
 - 10°C – +40°C
- ▶ Representative Performance
 - Electric strength : 2,000V 1 min
 - Operation test : 10,000 Operations
 - Temperature rise : Test current 25A (4 mm²)
Not more than 45K (Terminals)
- ▶ Terminal
 - Pillar Terminal II
- ▶ Applicable Wire
 - 2.5 mm² - 6 mm²
 - 13 AWG - 10 AWG
- ▶ Terminal Capacity
 - 2.5 mm² × 2
 - 4 mm² × 1
 - 6 mm² × 1

Features

- Switching mechanism uses a coil spring system for a longer service life.
- Made with flame-retardant and heat-resistant urea resin.
- Conductive section uses heat-resistant copper with superior anticorrosion property and conductivity for long-term stable, reliable performance.
- Accepts wires : 2.5 mm² - 6 mm² solid wire to flexible wire (class 5).

Dimensions

BS-TYPE DP Switch with Indicator

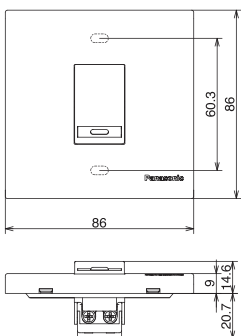

A-TYPE DP Switch with Indicator

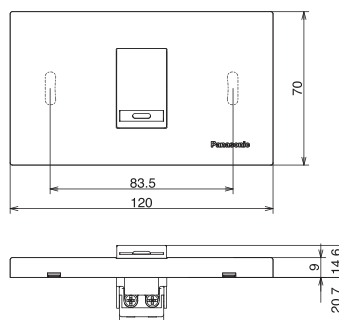

*BS-TYPE : M3.5 mounting screws included.

TECHNICAL DETAILS

FULL-COLOR WIDE SERIES

BS-TYPE , A-TYPE

FULL-COLOR WIDE SERIES Refina

BS-TYPE , A-TYPE

FULL COLOR
WIDE
SERIES

FULL-COLOR
WIDE
SERIES
Refina

Switches 45A

BS-TYPE DP Switch with Indicator



WBG5408699W
WZB7832WK-1
WNBP5428690F

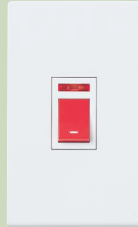

WBG5408699W
WZB7817
WNBP5448690F

A-TYPE DP Switch with Indicator



WBG5408699W
WN3020W , WZB7843W
WNGP5438693F

Technical Specifications

- ▶ Standards
Comply with BS3676:1989
- ▶ Rating
45A 250V~ (for a resistive circuit)
25A 250V~ (for a motor-load circuit)
- ▶ Ambient Temperature
-10°C – +40°C
- ▶ Representative Performance
 - Electric strength : 1,500V 1 min
 - Operation test : 10,000 Operations
 - Temperature rise : Test current 51A (10 mm²)
Not more than 45K (Terminals)
- ▶ Terminal
Screw Terminal
- ▶ Applicable Wire
4 mm² - 10 mm² Stranded wire
4 mm² - 6 mm² Solid wire
- ▶ Terminal Capacity
4 mm² × 1
6 mm² × 1
10 mm² × 1

Features

- High-capacity silver contact for longer life.
- Made with flame-retardant and heat-resistant melamine phenol/urea resins.
- Conductive section uses heat-resistant copper with superior anticorrosion property and conductivity for long-term stable, reliable performance.
- Accepts wires : 4 mm² - 10 mm² solid wire and flexible wire.
- Built-in lighted indicator shows On/Off status.
- Normal gap double-pole switch (minimum contact gap : 3 mm) construction ensures safe load shut-off.

Dimensions

BS-TYPE DP Switch with Indicator

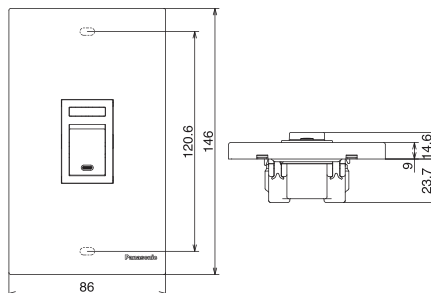
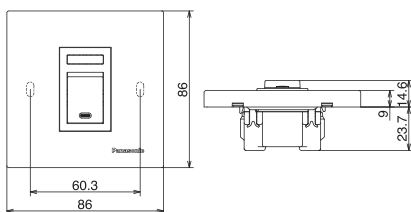

A-TYPE DP Switch with Indicator

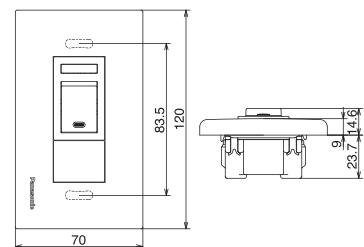

*BS-TYPE : M3.5 mounting screws included.

FULL-COLOR WIDE SERIES BS-TYPE , A-TYPE
 FULL-COLOR WIDE SERIES Refina BS-TYPE , A-TYPE

FULL COLOR
WIDE
 SERIES

FULL-COLOR
WIDE
 SERIES
Refina

Dimmer Switches

BS-TYPE 1000W

500W

A-TYPE 400W



WEG5781103



**WEG578153
 WEB7812W**

WEBP5726350F



**WEG57514
 WEG68029WK-P**

WEGP5719140F

Technical Specifications

WEG5781103

- ▶ Rating
220V-240V~ 50/60Hz 1000W
- ▶ Ambient Temperature
0°C – +35°C
- ▶ Terminal
Pillar Terminal
- ▶ Applicable Wire
1 mm² - 4 mm²

WEG578153

- ▶ Rating
220V-240V~ 50/60Hz 500W
- ▶ Ambient Temperature
0°C – +35°C
- ▶ Terminal
Screw Terminal
- ▶ Applicable Wire
1 mm² - 2.5 mm²

Features

WEG5781103

- New pillar terminal accommodates 1 mm² - 4 mm² solid wire to stranded wire.
- Compatible with 800VA copper/steel and step-down transformers. (applicable for low-voltage halogen lamp use)
- Applicable for 1000W incandescent lamp.

WEG578153

- Applicable Wires : 1 mm² - 2.5 mm²
- Compatible with 500VA copper/steel and step-down transformers.
- Applicable for low-voltage halogen lamp use.
- Applicable for 500W incandescent lamp.

*Those products can't operate ventilating / ceiling fan.

Dimensions

BS-TYPE 1000W

500W

A-TYPE 400W

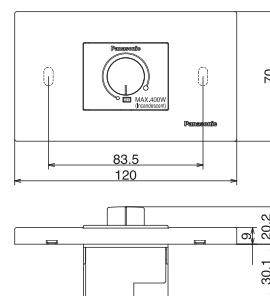
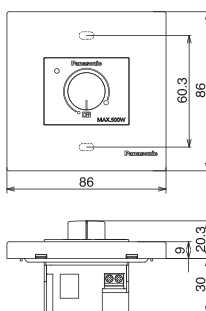
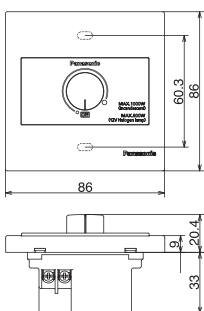

*BS-TYPE : M3.5 mounting screws included.

TECHNICAL DETAILS

FULL-COLOR WIDE SERIES BS-TYPE
 FULL-COLOR WIDE SERIES Refina BS-TYPE

FULL-COLOR
WIDE
 SERIES

FULL-COLOR
WIDE
 SERIES
Refina

Socket Outlets

BS-TYPE Switched Socket

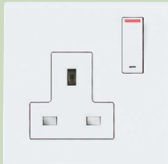

WEB1111WK

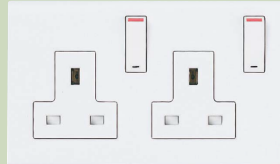

WEB1112WK

Technical Specifications

- ▶ Standards
Comply with BS1363-2
- ▶ Rating
13A 250V~
- ▶ Ambient Temperature
-10°C – +40°C
- ▶ Representative Performance
 - Electric strength : 2,000V 1 min
 - Operation test : 15,000 times (30,000 movements)
 - Temperature rise : Test current 20A (2.5 mm²)
Not more than 52K (Terminals)
- ▶ Terminal
Pillar Terminal II
- ▶ Applicable Wire
1.5 mm² - 4 mm²
15 AWG - 12 AWG
- ▶ Terminal Capacity
 - 1.5 mm² × 3
 - 2.5 mm² × 3
 - 4 mm² × 2

Features

- Socket Outlet with a double-pole switch completely isolates load from power supply.
- Socket Outlet housing uses flame-retardant and heat-resistant urea resin with high anti-tracking properties.
- Accepts wires : 1.5 mm² - 4 mm² solid wire to flexible wire.
- Both socket and switch parts made for enough switching capability.
- Included safety shutter prevents kids from tampering with switch.

Dimensions

BS-TYPE Switched Socket

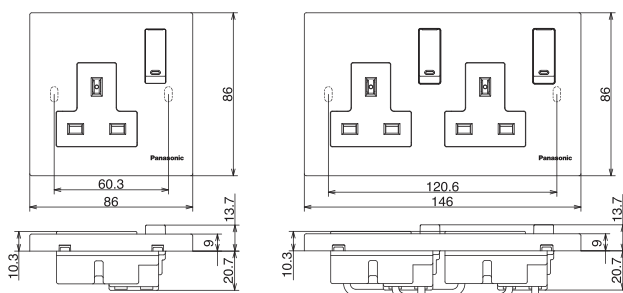

*BS-TYPE : M3.5 mounting screws included.

Applicable Box

BS-TYPE



- ▶ Dimensions
 - Plate : 86 x 86 mm
 - Box : 72 x 72 mm
 - Fixing Center : 60.3 mm



- ▶ Dimensions
 - Plate : 86 x 146 mm
 - Box : 72 x 132 mm
 - Fixing Center : 120.6 mm

FULL-COLOR WIDE SERIES BS-TYPE , A-TYPE
 FULL-COLOR WIDE SERIES Refina BS-TYPE , A-TYPE

FULL COLOR
WIDE
 SERIES

FULL-COLOR
WIDE
 SERIES
Refina

Accessories - Television

BS-TYPE DIN Type



WEG2501-P
WEB7811W

WEBP4719830F



WEG2501-P
WEB7812W

WEBP4729830F

A-TYPE DIN Type



WEG2501-P
WEG6801WK-P

WEGP4719830F

Technical Specifications

- ▶ Connector Type (Outlet) : DIN Type
- ▶ Terminal
Screw Terminal (Only coaxial core isn't screw terminal type)
- ▶ Impedance Input, Outlet : 75Ω
- ▶ Applicable Cable
Coaxial cable Characteristic Impedance 75Ω type : 5C - 2V, 3C - 2V

Features

“Easy Connect” terminal for direct insertion of coaxial cable core.

Insert fully and tighten clamp.

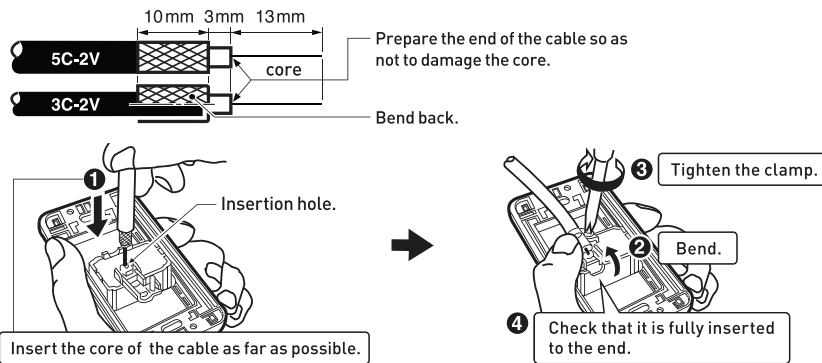

Dimensions

BS-TYPE DIN Type

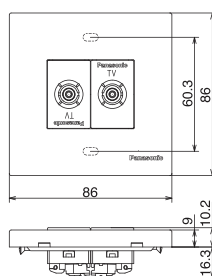
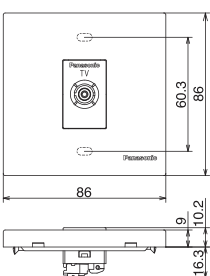

A-TYPE DIN Type

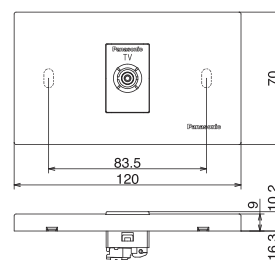

*BS-TYPE : M3.5 mounting screws included.

TECHNICAL DETAILS

FULL-COLOR WIDE SERIES BS-TYPE , A-TYPE
 FULL-COLOR WIDE SERIES Refina BS-TYPE , A-TYPE

FULL-COLOR
WIDE
 SERIES

FULL-COLOR
WIDE
 SERIES
Refina

Accessories - Telephone

BS-TYPE 6P4C



WEG2364
WEB7811W

WEBP4519940F



WEG2364
WEB7812W

WEBP4529940F

A-TYPE 6P4C



WEG2364
WEG6801WK-P

WEGP4519940F

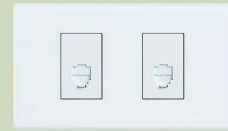

WEG2364
WEG6802WK-P

WEGP4529940F

Technical Specifications

- ▶ Connector Type
 Miniature Modular Jack, 6 position with 4-contacts, specified in TIA-1096-A (Previously in FCC part 68)
- ▶ Terminal
 Quick Connect Terminal (Screwless Connection)
- ▶ Applicable Wire
 Paired quad-type PVC indoor cable : Core wire to be 0.4 mm, 0.5 mm, 0.65 mm, in diameter (solid copper only)
 2-pair Business-phone indoor cable : Core wire to be 0.4 mm, 0.5 mm, 0.65 mm, in diameter (solid copper only)

Features

- Quick Connect Terminal increases connection reliability.
- Quick Connect Terminal for easy connection.
- Simple Connection
 Just insert cable into the terminal hole.
- Easy Cable Disconnection
 Push removal button while pulling out cable.

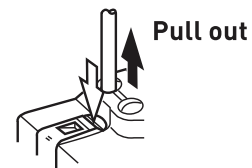
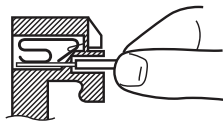

Dimensions

BS-TYPE 6P4C

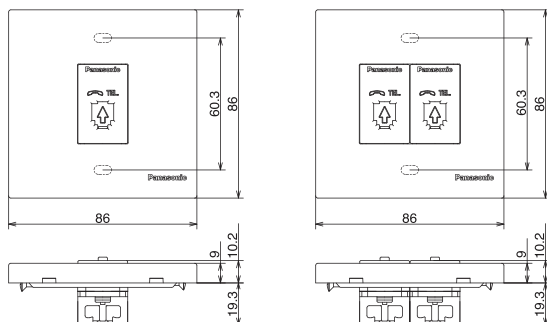

A-TYPE 6P4C

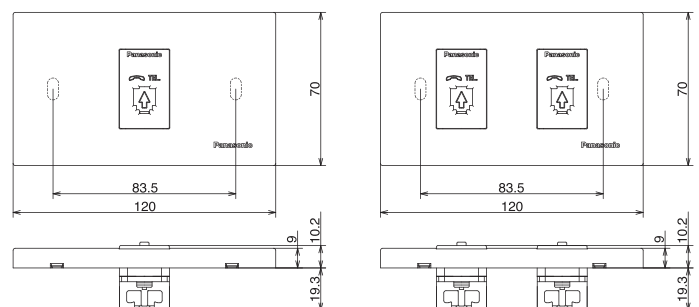

*BS-TYPE : M3.5 mounting screws included.

Accessories - LAN

BS-TYPE Category 5e , Category 6

A-TYPE Category 5e

Category 6



WEG2488-P
WEB7811W

WEBP4519980F



WEG24886-P
WEB7811W

WEBP4519680F

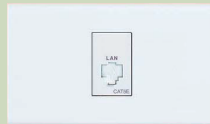

WEG2488-P
WEG6801WK-P

WEGP4519980F

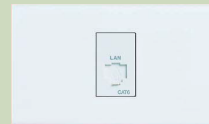

WEG24886-P
WEG6801WK-P

WEGP4519680F



WEG24886-P
WEG6802WK-P

WEGP4529680F

Technical Specifications

- ▶ Connector Type
 "8-way unshielded fixed connector (miniature 8-position modular jack)" specified in IEC 60603-7
- ▶ Terminal
 IDC connection
- ▶ Applicable Cable
 - WEG2488 : 4-pair UTP cable, Category 5e
 Conductor : solid copper wire, 22 AWG - 24 AWG (diameter : 0.5 mm-0.65 mm)
 : or stranded copper wire, 24 AWG
 - WEG24886 : 4-pair UTP cable, Category 6
 Conductor : solid copper wire, 22 AWG - 24 AWG (diameter : 0.5 mm-0.65 mm)

Features

1 It's not necessary to use special wiring tool.

2 No need to untwist the wires.

Pin/Pair assignment

2-way connection

Toolless

Using wiring tool

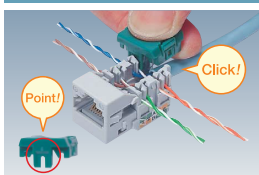

Cut the excess wires with nippers after connection

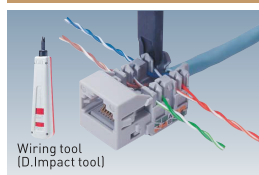

Excess wires can be cut with the blade edge of the tool

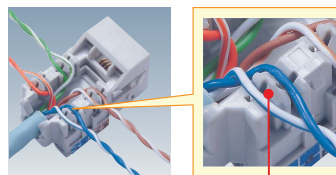

Projection between the slots

No need to untwist the wires to setting on the slots.
 Minimum untwisting retains uniform installation quality and transmission performance.

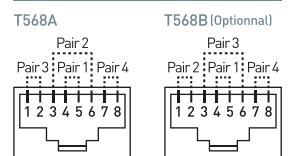

| Pair | Color | Pin No. | |
|------|-------|---------|-------|
| | | T568A | T568B |
| 1 | W/BL | 5 | 5 |
| | BL | 4 | 4 |
| | W/O | 3 | 1 |
| 2 | O | 6 | 2 |
| | W/G | 1 | 3 |
| 3 | G | 2 | 6 |
| | W/BR | 7 | 7 |
| 4 | BR | 8 | 8 |

Dimensions

BS-TYPE Category 5e , Category 6

A-TYPE Category 5e

Category 6

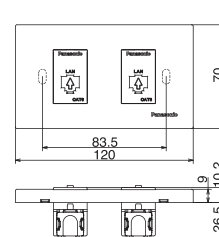
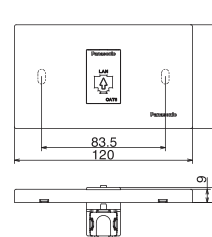
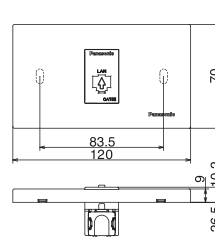
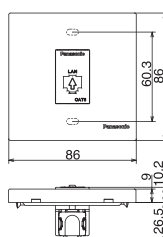
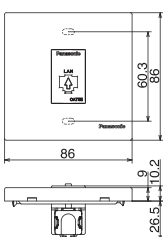

*BS-TYPE : M3.5 mounting screws included.

TECHNICAL DETAILS

FULL-COLOR WIDE SERIES BS-TYPE , A-TYPE
FULL-COLOR WIDE SERIES Refina BS-TYPE , A-TYPE

FULL COLOR
WIDE
SERIES

FULL-COLOR
WIDE
SERIES
Refina

Others

4G Switch



WNBP5140630

Technical Specifications

- ▶ Standards
Comply with IEC60669-1
 - ▶ Rating
15AX 250V~
 - ▶ Ambient Temperature
-10°C – +40°C
 - ▶ Representative Performance
 - Electric strength
: 2,000V 1 min
 - Operation test
: 40,000 Operations
 - Temperature rise
: Test current 20A (2.5 mm²)
Not more than 45K (Terminals)
 - ▶ Terminal
Screw Terminal
 - ▶ Applicable Wire
1.5 mm² - 3.5 mm²
14 AWG - 12 AWG
 - ▶ Terminal Capacity
 - 1.5 mm² × 1
 - 3.5 mm² × 1
 - 14 AWG × 1
 - 12 AWG × 1
- *Supply terminal has 2 terminal holes.

Push Button



WEBP5113650F

Technical Specifications

- ▶ Standards
Comply with IEC60669-1
 - ▶ Rating
10AX 250V~
 - ▶ Ambient Temperature
-10°C – +40°C
 - ▶ Representative Performance
 - Electric strength
: 2,000V 1 min
 - Operation test
: 40,000 Operations
 - Temperature rise
: Test current 13.5A (2.5 mm²)
Not more than 45K (Terminals)
 - ▶ Terminal
Screw Terminal
 - ▶ Applicable Wire
1 mm² - 2.5 mm²
 - ▶ Terminal Capacity
 - 1 mm² × 1
 - 1.5 mm² × 1
 - 2.5 mm² × 1
- *Supply terminal has 2 terminal holes.

TV Socket F Type



WEBP47194501F

Technical Specifications

- ▶ Connector Type (Outlet) : F type
- ▶ Terminal
Screw Terminal
(Only coaxial core isn't screw terminal type)
- ▶ Impedance Input, Outlet : 75Ω
- ▶ Applicable Cable
Coaxial Cable
Characteristic Impedance 75Ω type : S-5C-FB

Universal Socket



WEBP1914610F

Technical Specifications

- ▶ Standards
 - Comply with IEC60884-1
- ▶ Rating
 - 16A 250V~
- ▶ Ambient Temperature
 - 10°C – +40°C
- ▶ Representative Performance
 - Electric strength
 - : 2,000V 1 min
 - Operation test
 - : 5,000 times (10,000 movements)
 - Temperature rise
 - : Test current 22A (2.5 mm²)
 - Not more than 45K (Terminals)
- ▶ Terminal
 - Screw Terminal
- ▶ Applicable Wire
 - 1.5 mm² - 4 mm²
 - 15 AWG - 12 AWG
- ▶ Terminal Capacity
 - 1.5 mm² × 3
 - 2.5 mm² × 3
 - 4 mm² × 2

15A 3Pin Socket

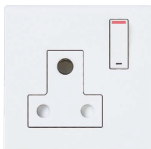

WEB1131W

Technical Specifications

- ▶ Standards
 - Comply with BS546
- ▶ Rating
 - 15A 250V~
- ▶ Ambient Temperature
 - 10°C – +40°C
- ▶ Representative Performance
 - Electric strength
 - : 1,500V 1 min
 - Operation test
 - : 15,000 times (30,000 movements)
 - Temperature rise
 - : Test current 15A (2.5 mm²)
 - Not more than 35K (Terminals)
- ▶ Terminal
 - Screw Terminal
- ▶ Applicable Wire
 - 2.5 mm² - 4 mm²
- ▶ Terminal Capacity
 - 1.5 mm² × 3
 - 2.5 mm² × 3
 - 4 mm² × 2

American Socket



WEBP1619610F

Technical Specifications

- ▶ Standards
 - Comply with SASO 2204(2003)
- ▶ Rating
 - 15A 127V~
- ▶ Ambient Temperature
 - 10°C – +40°C
- ▶ Representative Performance
 - Electric strength
 - : 2,000V 1 min
 - Operation test
 - : 15,000 times (30,000 movements)
 - Temperature rise
 - : Test current 15A (2.5 mm²)
 - Not more than 35K (Terminals)
- ▶ Terminal
 - Screw Terminal
- ▶ Applicable Wire
 - 1.5 mm² - 4 mm²
 - 15 AWG - 12 AWG
- ▶ Terminal Capacity
 - 1.5 mm² × 3
 - 2.5 mm² × 3
 - 4 mm² × 2